

TOSVERT VF-PS1 series

Metasys[®] N2 option unit Instruction Manual

MTS001Z

NOTICE



1. Make sure that this instruction manual is delivered to the end user of Metasys[®] N2 option unit.
2. Read this manual before installing or operating the Metasys[®] N2 option unit.
Keep it in a safe place for reference.
3. All information contained in this manual are subject to change without notice.
Please confirm the latest information on our web site “www.inverter.co.jp”.

Safety precautions

On the inverter and in its instruction manual, important information is contained for preventing injuries to users, damages to assets, and for proper use of the device.

Read the instruction manual attached to the inverter along with this instruction manual to completely understand the safety precautions, the symbols and indications shown below. Please adhere to the contents of these manuals at all times.





Explanation of markings

Marking	Meaning of marking
 Danger	Indicates that errors in operation may lead to death or serious injury.
 Warning	Indicates that errors in operation may lead to injury (*1) to people or that these errors may cause damage to physical property. (*2)

(*1) Such things as injury, burns or shock that will not require hospitalization or long periods of outpatient treatment.

(*2) Physical property damage refers to wide-ranging damage to assets and materials.







Meanings of symbols

Marking	Meaning of marking
	Indicates prohibition (Do not do it). What is prohibited will be described in or near the symbol in either text or picture form.
	Indicates something mandatory (must be done). What is mandatory will be described in or near the symbol in either text or picture form.
	Indicates danger. What is dangerous will be described in or near the symbol in either text or picture form.
	Indicates warning. What the warning should be applied to will be described in or near the symbol in either text or picture form.



■ Limitation of use

 Safety precaution	
▼	Never use this unit with any device other than TOSVERT VF-PS1 series inverters. Doing so may cause an accident.



■ Handling in general

 Danger	
 Never Disassemble	<ul style="list-style-type: none"> ▼ Never disassemble, modify or repair the product. Disassembling the product may cause electric shocks, fire or injuries. For repairs, call your sales/repair agency.
 Prohibited	<ul style="list-style-type: none"> ▼ Do not open the front cover on the inverter while the inverter power is on. It may lead to electric shocks. ▼ Do not remove this option from VF-PS1 while the power is on. It may lead to electric shocks. ▼ Do not put or insert foreign objects such as waste cable, bars or wires into the product. It may lead to electric shocks or fire. ▼ Do not splash water over the product, and do not wipe the body with a wet cloth. It may lead to electric shocks or fire.
 Mandatory	<ul style="list-style-type: none"> ▼ Turn off the power immediately in case of any abnormalities such as smoke, smell or abnormal noise. Neglect of these conditions may lead to fire. For repairs, call your sales/repair agency. ▼ Do not touch the sharp portions (such as leads of parts on the board, the corner of board, or etc.) on this option. It may lead to injuries.
 Warning	
 Mandatory	<ul style="list-style-type: none"> ▼ This option is an electrostatic discharge sensitive device. Handle it, where the environment is protected against electrostatic electricity. Otherwise, permanent damage to device will result.





■ Transportation and installation

 Danger	
 Prohibited	<ul style="list-style-type: none"> ▼ Do not apply a dropping shock or other physical shocks. Otherwise, damage or malfunction will result. ▼ Do not install or operate the inverter if it is damaged or any part of it is missing. Operating a defective inverter may lead to electric shocks or fire. For repairs, call your sales/repair agency. ▼ Do not put any flammable material near the product. It may catch fire due to the product sparking in the case of a malfunction.
 Mandatory	<ul style="list-style-type: none"> ▼ Use this product under the environmental conditions prescribed in the instruction manual. Usage it under any other conditions may result in malfunction. ▼ An emergency stop device must be installed that fits with system specifications (e.g. shut off input power then engage mechanical brake). Operation cannot be stopped immediately by the inverter or this unit alone, thus risking an accident or injuries.



■ Wiring

 Warning	
 Mandatory	<ul style="list-style-type: none"> ▼ Electrical construction work must be done by a qualified expert. Connection of input power by someone who does not have expert knowledge may result in electric shocks or fire. ▼ Turn off input power before wiring. Wait at least 15 minutes and make sure that the charge lamp (on the inverter unit) is no longer lit. Otherwise, it may lead to electric shocks.

■ Operations

 Danger	
 Prohibited	<ul style="list-style-type: none"> ▼ Do not pull on the cable and connector. It may cause damage or malfunctions.
 Mandatory	<ul style="list-style-type: none"> ▼ Use this option under the environment specified in the instruction manual. Usage under the environment other than them may cause damages or malfunctions or an accident. ▼ Use an additional safety device with your inverter or system to prevent a serious accident due to the unit malfunctions. Usage without an additional safety device may cause an accident.
 Warning	
 Mandatory	<ul style="list-style-type: none"> ▼ Set up “Communication error trip function (see below)” to stop the inverter when the option unit is deactivated by an unusual event such as an operating error, power outage, failure, etc. <ul style="list-style-type: none"> - Network time-out (f832) (See the VF-PS1 Metasys® N2 Communication Function Manual for details.) Deactivated option unit may cause an accident, if the “Communication error trip function” is not properly set up. ▼ Make sure that the operation signals are STOP before resetting inverter’s fault. The motor may suddenly start and that may result in injuries.

■ Disposal

 Warning	
 Mandatory	<ul style="list-style-type: none"> ▼ If you dispose off this unit, have it done by a specialist in industrial waste disposal*. Improper disposal may result in explosion of capacitors or produce noxious gases, resulting in injuries. (*) Persons who specialize in the processing of waste and known as “Industrial Waste Product Collectors and Transporters” or “Industrial Waste Disposal Persons.” If the collection, transport and disposal of industrial waste is done by someone who is not licensed for that job, it is a punishable violation of the law (Laws in regard to cleaning and processing of waste materials).

■ Notes on operation

Notes	
	<ul style="list-style-type: none"> ▼ Avoid installing in a place where ambient temperature or/and humidity change sharply. ▼ Keep the transmission cable separate from the power cable of the inverter to prevent the inverter from malfunctioning due to electromagnetic noise. ▼ Ground of SCR terminal on this option at the grounding terminal separated from those of inverters and motors. It may cause malfunction due to noise.

Preface

Thank you for purchasing the “Metasys® N2 option (MTS001Z)” for TOSVERT VF-PS1 inverter. By installing this board into the VF-PS1, data communication can be made with a host computer or other device via Metasys® N2 network.

Before using this unit, carefully read this instruction manual in order to completely and correctly utilize excellent performance of this unit. Besides this instruction manual, the “Metasys® N2 option Function Manual” which includes the contents to install into Metasys® N2 network is prepared. If it is required, please contact with our branch offices, sales offices or web site “www.inverter.co.jp”.

(“Metasys® N2 option Function Manual”: E6581540)

After reading this instruction manual, please keep it handy for future reference.

* Metasys® N2 is a registered trademark of Johnson Controls Inc.

- Part numbering

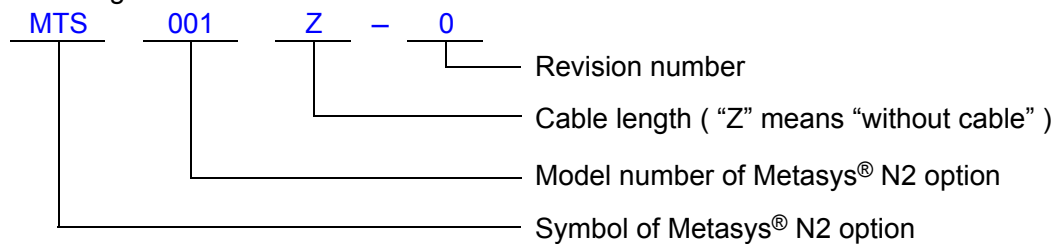

- Accessory check list

Metasys® N2 communication option is shipped together with the following accessories. On opening the packing case, check to see if the following accessories are contained or not.

- (1) Metasys® N2 option (MTS001Z) 1 board

Connector: MSTB2.5/4-STF-5.08

Manufactured by PHOENIX CONTACT

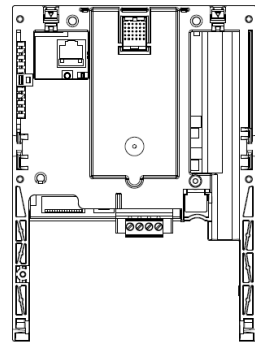

- (3) Instruction manual for the VF-PS1 Metasys® N2 option 1 copy

(English: E6581539
(This manual)

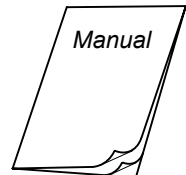

- (4) LED name label 1 sheet

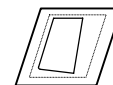

Table of Contents

1. Overview	6
2. Names and functions.....	6
2.1. Outline.....	6
2.2. Metasys® N2 Connector.....	6
2.3. LED indicator.....	7
3. Installing the MTS001Z	8
3.1. Network cable connection	9
3.2. Network configuration.....	9
4. Parameters.....	10
4.1. Communication parameters	10
4.2. f832: Network Time-Out	10
4.3. f851: Operation at communication error by disconnection	11
4.4. f852: Preset speed operation selection	11
5. The Metasys® N2 Local/Remote Operation	12
6. Specifications	13
7. Warranty.....	13

1. Overview

The Metasys[®] N2 interface (MTS001Z) allows the VF-PS1 inverter to be connected into a Metasys[®] N2 network.

2. Names and functions

The drawing below shows names and functions of main parts.

2.1. Outline

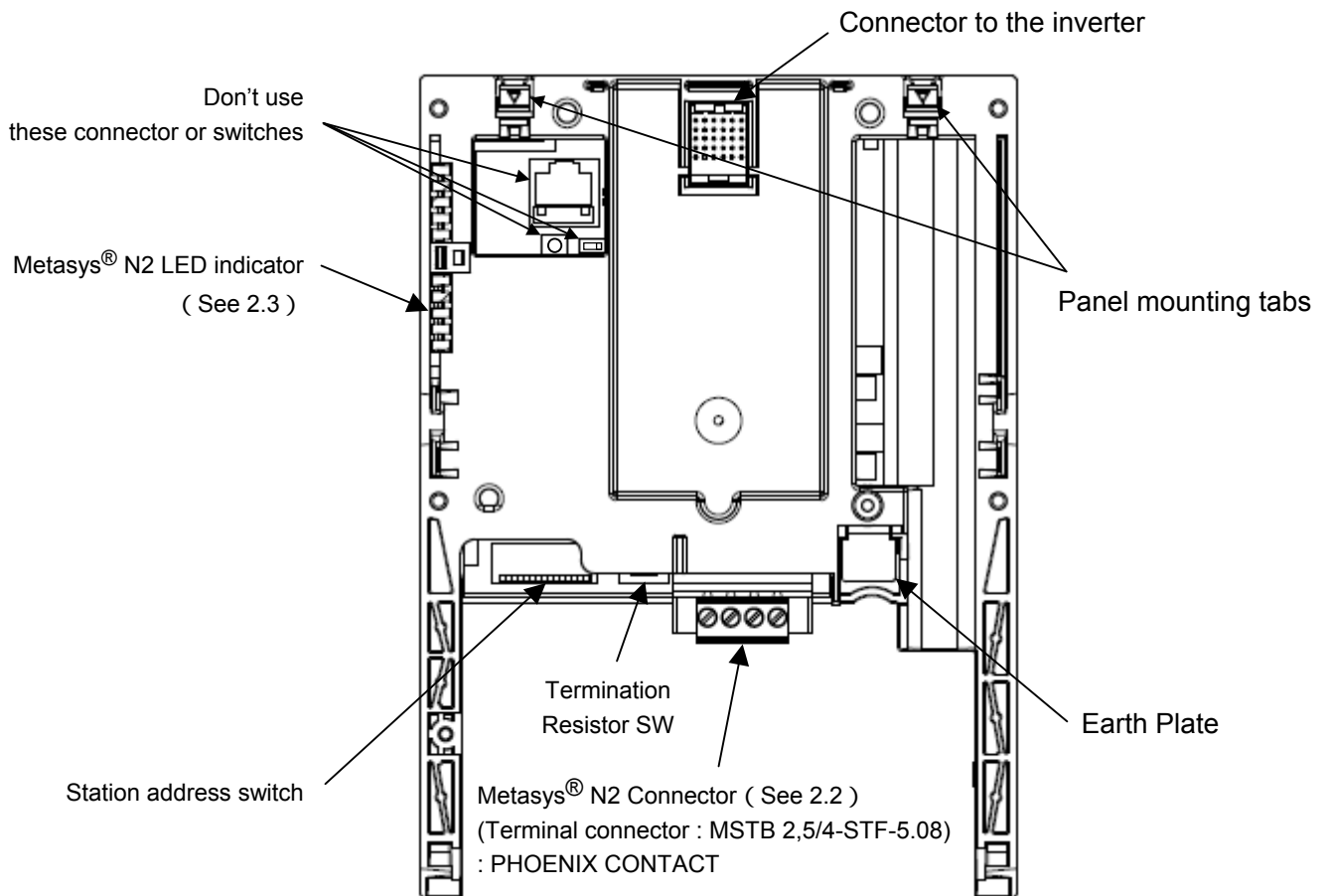

2.2. Metasys[®] N2 Connector

Terminal symbol	Function	Electrical specifications	Internal circuits
B	Metasys [®] N2 communication signal EIA-485	Communication signal (+)	
A		Communication signal (-)	
GND		Signal common	
SCR		Shield terminal.	

2.3. LED indicator

The LED shows the present status of the network and error.

Layout of LED

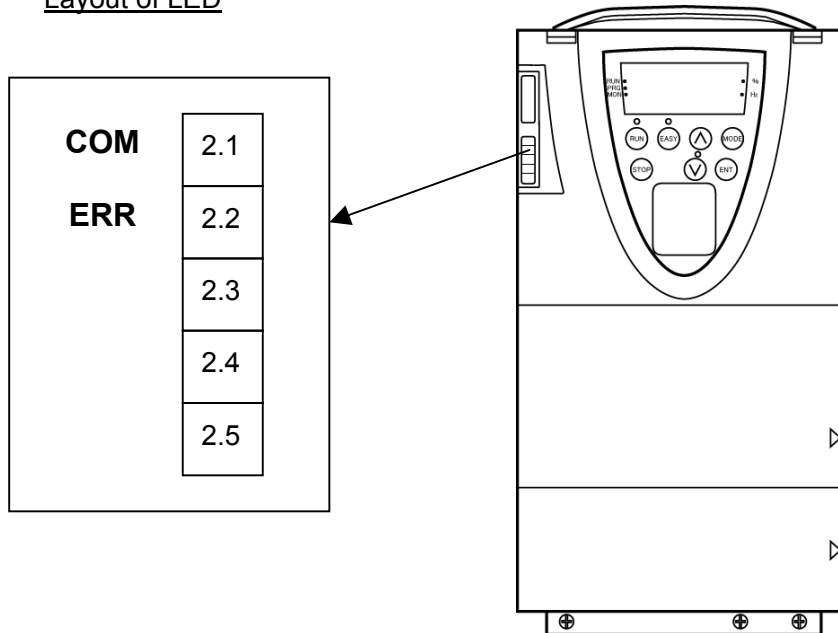

The option has two LEDs. Those function are below table.

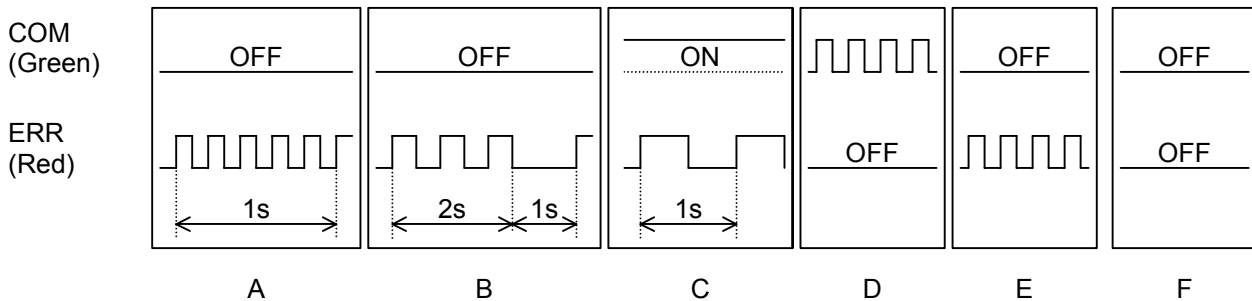

State	LEDs	Comment
A	COM LED: OFF ERR LED: Flashing 5 times in 1 sec	Metasys® N2 failure.
B	COM LED: OFF ERR LED: 3 times in 2 sec, Off for 1 sec	Communication loss detected. Confirm the network condition and connection of the cable.
C	COM LED: ON ERR LED: OFF 0.5 sec, ON 0.5 sec	Invalid configuration detected. Note: When inverter occurred in e-23 or e-24, the LED becomes this state.
D	COM LED: Flashing ERR LED: OFF	Valid message received for this node
E	COM LED: OFF ERR LED: Flashing	Invalid message received (any node)
F	COM LED: OFF ERR LED: OFF	No communication Confirm the network condition and connection of the cable.

3. Installing the MTS001Z

Install the Metasys[®] N2 option to VF-PS1 as follows.

Please install this option (MTS001Z) on the top of options when you install two options.

Do not install under the another option.

- (1) Turn off input power of VF-PS1 and wait for at least 15 minutes and then check that the CHARGE lamp on VF-PS1 is no longer lit.
- (2) Securing the option to the inverter
 - a) Insert a flat-blade screwdriver in each of the two holes at the upper part of the front panel, release the panel mounting tab by pushing the screwdriver down and remove the front panel cover.
 - b) Install the option in the inverter by fitting the tabs on the lower side the option into the slots at the lower part of the inverter front panel.
 - c) Make sure the option is securely attached to the inverter. Then check whether the plastic bosses on the inverter case have fitted in the holes at the upper and lower parts of the option.
 - d) Insert the tabs at the lower part of the front cover into the slots at the lower part of the inverter to attach the front cover to the inverter.
 - e) Stuck the enclosed "LED name label" in the option LED display part of a front cover.

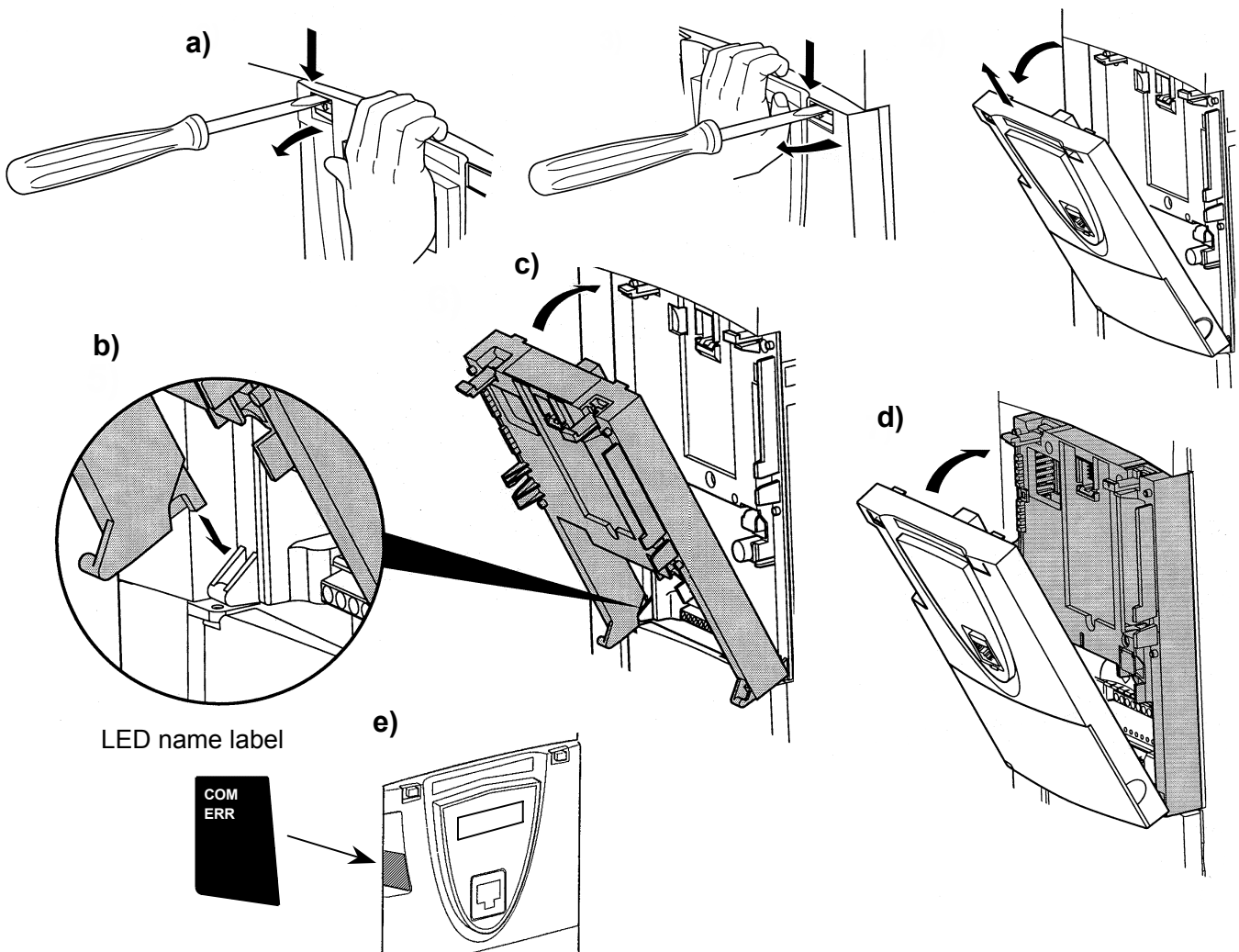

3.1. Network cable connection

Connect the Metasys[®] N2 network cable to communication option as follows.

Title	Description
Wire type	Shielded twisted cable
Characteristic impedance	Between 100 and 130 ohm
Distributed impedance between conductors	Less than 100pF per meter
Distributed impedance between conductors and shield	Less than 200pF per meter Foil or braided shield are acceptable.
Length of an MSTP segment	1200 meters with AWG18 (0.8mm ²)

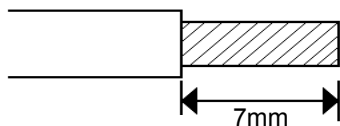

Cable sheath should be peeled off by about 7mm.

For wiring work, use a flat blade screwdriver with a 0.6mm thick and 3.5mm width blade.

Tightening torque for the terminal block is 0.5Nm.

* Fix a cable so that a communication connector may be not taken the weight of wire.

3.2. Network configuration

Make up the network as follows.

- Transmission/reception signals (A, B)

Make up the communication path by connecting all transmission/reception data cables.

- Signal common (GND)

GND is the signal common.

- Grounding the shield of cable (SCR)

Connect the all shield lines of network cable. The shield shall be grounded at one end only prevent currents from being created.

- Termination resistor

A termination resistance of 120 ohms plus or minus 5% shall be connected at each of the two ends of the segment medium. This option has a termination resistor, so if use, set up the termination resistor SW. (Refer to 2.1 Outline)

At least one set, and no more than two sets, of network bias resistors shall exist for each segment.

This option has local bias resistors.

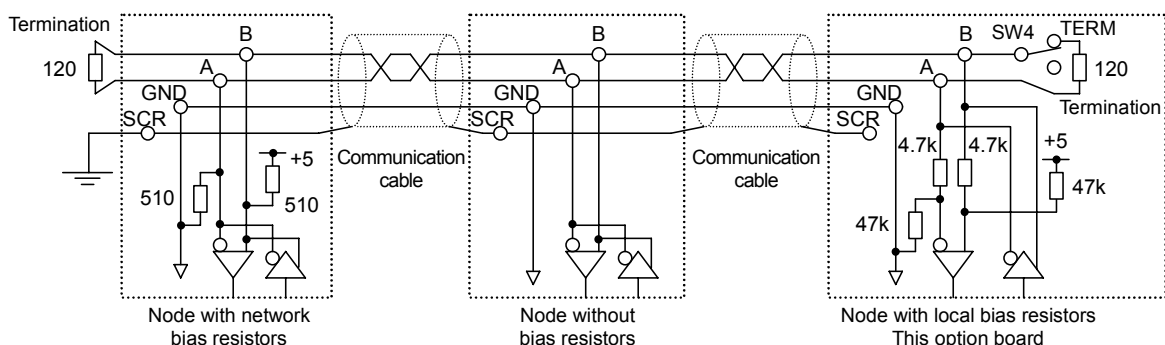

N.B.: Do not connect the SCR terminal to the power ground of inverters or other units.

Keep the network cables 20cm or more separate from the power cables to prevent from malfunctioning due to electromagnetic noise.

4. Parameters

4.1. Communication parameters

Set up the inverter parameters as follows. To update, reset of inverter. If these parameters are not set to correct value, this unit can not work normally.

Title	Function	Description	
F832	Network Time-Out	0: No action Unit: 0.1 sec, Setting range: 1 - 1000	0000 *
f851	Operation at communication error by disconnection	0: Inverter stop, communication command, frequency mode open (by cmod, fmod) 1: None (continued operation) 2: Deceleration stop 3: Coast stop 4: Network error (err8 trip) 5. Preset speed operation command (Operating at the preset speed operation frequency set with f852)	0
f852	Preset speed operation selection	0: None 1 - 15: Preset speed operation	0
f853	Communication option station address monitor (Read Only)	Station address (setup by switch) monitor	-
F899	Network option reset setting	0: None 1: Reset option board and inverter	0

* f832 must be set up by a hexadecimal number.

ex.) 100.0 sec = 0x3E8

** When the parameters are changed, the power must be cycled (or set f899 to 1) to the VF-PS1 for the changes to take effect.

Note) When cmod or fmod is set to "Communication option input", VF-PS1 drives without RSCMDMOD (Binary Output Object - 10) or FRCMDMOD (Binary Output Object - 11) at each Objects.

4.2. f832: Network Time-Out

Set the communication loss action time to f832. The network loss action function starts from receiving the properly frame message. The action of the network communication loss is set by f851.

4.3. f851: Operation at communication error by disconnection

This parameter sets up the **VF-PS1** response to a loss of communications with the Metasys[®] N2 network.

0: Stop and Communication release

The inverter decelerates the motor to a stop and gives an L alarm (the leftmost LED L flashes). Commands entered through the network are canceled, and the commands set with parameters c_{mod} and f_{mod} become effective.

When communications are restored, the L alarm is turned off.

1: None

The inverter remains in the state where it was when the problem arose, and it gives an L alarm.

2: Deceleration stop

The inverter decelerates the motor to a stop and gives an L alarm. Commands entered through the network are not canceled.

3: Coast stop

The inverter issues a command for a frequency of 0Hz and gives an L alarm.

Commands entered through the network are not canceled.

4: Emergency stop

The error message $er\ r8$ is displayed. Commands entered through the network are not canceled.

When communications are restored, the inverter is not restored to working order and the error message $er\ r8$ does not disappear until the inverter is reset.

5: Preset speed operation command

Refer to Section 4.4.

4.4. f852: Preset speed operation selection

If the communication loss action (parameter **f851**) is set to 5 (preset speed command), the **VF-PS1** will run at a preset speed as set up by this parameter in the case of a communication loss (with L alarm). Commands entered through the network are not canceled.

For example,

If the inverter is set as described below,

f851 = 5 (preset speed operation command)

f852 = 8 (preset speed operation frequency 8)

f287 (preset speed operation frequency 8) = 10 (10Hz)

Operation is carried out as follows.

Network	Operation of the VF-PS1
Normal conditions	Operates according to commands entered through the network.
↓	↓
Communications loss.....	Operates at 10Hz.
↓	↓
Restoration.....	Operates according to commands entered through the network.

5. The Metasys® N2 Local/Remote Operation

The example below shows how to configure the **VF-PS1** for local/remote operation.

F terminal.....Operating command

R terminal.....The Metasys® N2 local/remote (Terminal in this example) switching

RR/S4 terminalOperation frequency command

<Wiring>

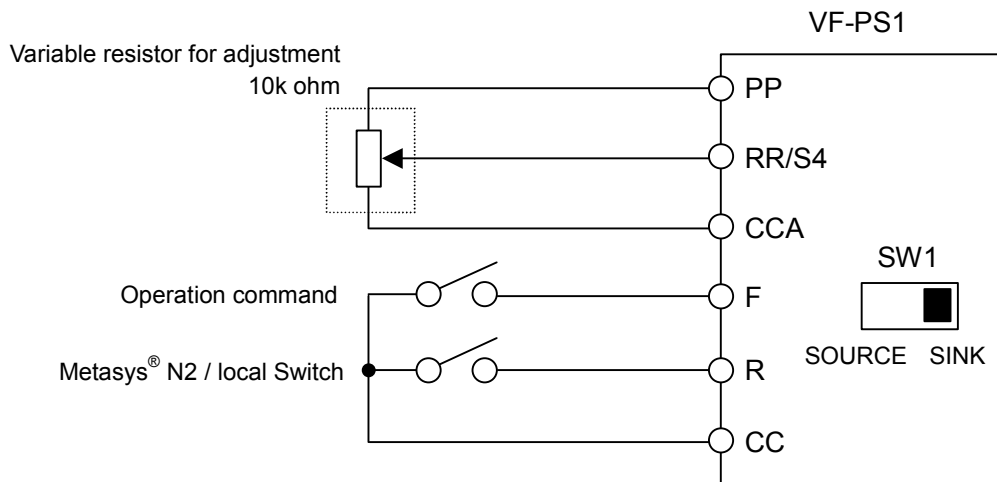

<Parameter setting>

cmod(Command mode selection) = 0 (Terminal board)

fmod(Frequency setting mode selection 1) = 2 (RR/S4)

f112(Input terminal selection 2 (R)) = 48 (Metasys® N2/Local control)

<Operation>

R-CC terminal open: **VF-PS1** is controlled as a slave device of The Metasys® N2.

R-CC terminal closed:

F-CC terminal short to RUN

F-CC terminal short to STOP

Output frequency is set up by the RR/S4 signal input.

Note) When "local / remote key" (2) is chosen as EASY key selection (f750) and EASY key lamp of an inverter front panel lights, priority is most given to operation by a panel. (Refer to the inverter instruction manual for details).

When operation/stop is by the control terminal and only a monitor is by N2, set the functional number 48 (communication priority release) to the unused control terminal and turn on or set 48 to the always active function selection (f110, or f127 or f128).

Note) The local mode of the panel has priority over Metasys® N2 local control.

6. Specifications

< Environmental specification >

Item	Specification
Model number	MTS001Z
Service environment	Indoors, an altitude of 3000m or less, where the product will not be exposed to direct sunlight, corrosive or explosive gasses, vapor, coarse particulate including dust, and where there is no grinding or grinding oil nearby.
Ambient temperature	-10 to +60°C
Storage temperature	-25 to +65°C
Relative humidity	20 to 93% (No condensation and absence of vapor)
Vibration	5.9m/s ² (0.6G) or less (10 to 55 Hz) (To be complied with JIS C0040.)
Power supply	5VDC supplied from the inverter

<[MTS001Z](#) network specification >

Item	Specification
Maximum node	255 nodes (32 nodes per segment)
Communication baud rate	9600bps
Bias resistor and termination	Local bias resistors are mounted. Termination resistor (120 ohm) can be select by SW.
Terminal block	Detachable terminal block 4-pole (5.08mm pitch) Manufacturer: PHOENIX CONTACT Type-Form : MSTB 2,5/4- STF-5.08

7. Warranty

Any part of Metasys[®] N2 communication option that is proved to be defective will be repaired free of charge under the following conditions:

1. This product will be repaired free of charge, if problem/fault occurs under normal handling within one year of delivery and is caused obviously by a design or manufacturing defect.
2. The warranty applies only to the delivered product.
3. For the following kinds of failure or damage, the repair cost shall be borne by the customer even within the warranty period.
 - i) Failure or damage caused by improper or incorrect use or handling, or unauthorized repair or modification of the inverter.
 - ii) Failure or damage caused by the unit falling or an accident during transportation after the purchase.
 - iii) Failure or damage caused by fire, salty water or wind, corrosive gas, earthquake, storm or flood, lightning, abnormal voltage supply, or other natural disasters.
 - iv) Damage due to the use of Metasys[®] N2 communication option for non-intended purposes.
4. If an additional warranty is provided then those conditions will also apply.