

TOSVERT VF-AS1/PS1

PROFIBUS-DP Option Instruction Manual

PDP002Z

Notice



1. Make sure that this instruction manual is delivered to the end user of the PROFIBUS option for the VF-AS1/PS1.
2. Read this manual before installing or operating the PROFIBUS option for the VF-AS1/PS1. And keep it in a safe place for reference.

* The data given in this manual are subject to change without notice.

Safety precautions

On the inverter and in its instruction manual, important information is contained for preventing injuries to users and damages to assets and for proper use of the device. Read the instruction manual attached to VF-AS1/PS1 along with this instruction manual for completely understanding the safety precautions and adhere to the contents of these manuals.





Explanation of markings

Marking	Meaning of marking
 Danger	Indicates that errors in operation may lead to death or serious injury.
 Warning	Indicates that errors in operation may lead to injury (*1) to people or that these errors may cause damage to physical property. (*2)





(*1) Such things as injury, burns or shock that will not require hospitalization or long periods of outpatient treatment.

(*2) Physical property damage refers to wide-ranging damage to assets and materials.



Meanings of symbols

Marking	Meaning of marking
	Indicates prohibition (Don't do it). What is prohibited will be described in or near the symbol in either text or picture form.
	Indicates something mandatory (must be done). What is mandatory will be described in or near the symbol in either text or picture form.
	Indicates danger. What is dangerous will be described in or near the symbol in either text or picture form.
	Indicates warning. What the warning should be applied to will be described in or near the symbol in either text or picture form.



■ General Operation

 Danger	
 Disassembly prohibited	<ul style="list-style-type: none"> ▼ Never disassemble, modify or repair. Doing so could result in electric shock, fire and injury. For repairs, call your sales agency.
 Prohibited	<ul style="list-style-type: none"> ▼ Do not attach this option to any inverter other than the VF-AS1/PS1. Doing so could result in electric shock or fire. ▼ When the inverter is energized, never detach the this option from the VF-AS1/PS1. Doing so could result in electric shock. ▼ Don't place or insert any kind of object into the PDP002Z (electrical wire cuttings, rods, wires). Doing so could result in electric shock or fire. ▼ Do not allow water or any other fluid to come in contact with the PDP002Z. Doing so could result in electric shock or fire.
 Mandatory	<ul style="list-style-type: none"> ▼ Turn off the VF-AS1/PS1 when installing and wiring the terminal block. ▼ If the inverter begins to emit smoke or an unusual odor, or unusual sounds, immediately turn power off. If the equipment is continued in operation in such a state, the result may be fire. Call your local sales agency for repairs.



■ Transportation & installation

 Danger	
 Prohibited	<ul style="list-style-type: none"> ▼ Do not operate the inverter if it is damaged or any component is missing. Doing so could result in electric shock or fire. Call your local sales agency for repairs. ▼ Do not place any inflammable substances near the VF-AS1/PS1 Inverter. If an accident occurs in which flame is emitted, this could lead to fire. ▼ Do not install in any location where the inverter could come into contact with water or other fluids. Doing so could result in electric shock or fire. ▼ When installing this option, be careful not to touch the leads from parts on the reverse side of its circuit board. Doing so could result in injury.
 Mandatory	<ul style="list-style-type: none"> ▼ Operate under the environmental conditions prescribed in the instruction manual. Operations under any other conditions may result in malfunction.



■ Wiring

 Danger	
 Mandatory	<ul style="list-style-type: none"> ▼ Shut off power when installing and wiring this option. Wait at least 15 minutes and check to make sure that the charge lamp (VF-AS1/PS1) is no longer lit. ▼ Electrical construction work must be done by a qualified expert. Installation or connection of input power by someone who does not have that expert knowledge may result in fire or electric shock.

■ Operations

 Danger	
 Prohibited	<ul style="list-style-type: none"> ▼ Do not touch switches when the hands are wet and do not try to clean the inverter with a damp cloth. Doing so could result in electric shock. ▼ Do not pull on any cable itself. Doing so could result in damage or malfunction.

■ Disposal

 Warning	
 Mandatory	<ul style="list-style-type: none"> ▼ For safety's sake, do not dispose of the disused inverter yourself but ask an industrial waste disposal agent (*). If the collection, transport and disposal of industrial waste is done by someone who is not licensed for that job, it is a punishable violation of the law. (Laws in regard to cleaning and processing of waste materials) (*) Persons who specialize in the processing of waste and known as "industrial waste product collectors and transporters" or "industrial waste disposal persons."

Notes on use

Notes	
	<ul style="list-style-type: none"> ▼ Do not install the inverter where the temperature or the humidity will change rapidly. ▼ Keep a distance of 20cm or more between the inverter's power cable and the data transmission cable. Or the inverter might malfunction because of noise. ▼ Insert a magnetic contactor or similar device between the inverter and the power supply to ensure that power is turned off if an emergency stop command is entered through the network.

Introduction

Thank you for purchasing a "VF-AS1/PS1 PROFIBUS Option (PDP002Z)," for TOSVERT VF-AS1/PS1 inverter. Installing this option in the VF-AS1/PS1 and using it together, data communication can be made with a host computer or other device via PROFIBUS DP (DP-V0). Please read the entire manual carefully before attempting to control your inverter via PROFIBUS connection.

Besides this instruction manual, the "PDP002Z Function Manual" is required to develop the software of communication with VF-AS1/PS1. In such a case, please get in touch with our branch offices or sales offices. ("PDP002Z Function Manual": E6581343).

This manual is also aimed at the operator using "VF-AS1/PS1 PROFIBUS option", so please use it for future maintenance and inspection.

■ Explanation of model number of PROFIBUS option

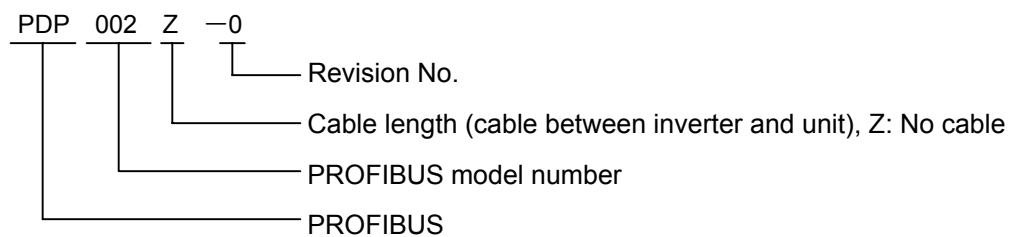

■ Check of accessories

PROFIBUS option is shipped together with the following items in the package. Contact your sales agency if any of these is missing.

- VF-AS1/PS1 PROFIBUS option 1 board
(PDP002Z)

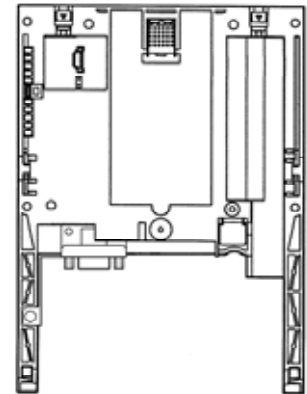

- Instruction manual for the VF-AS1/PS1 PROFIBUS option (this manual) 1 copy
(E6581279)

- LED name label 1 pcs.

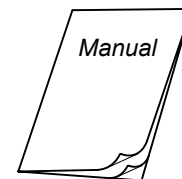
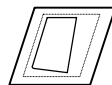

Contents

1. OVERVIEW	6
2. EXTERIOR FEATURES.....	7
2.1. PROFIBUS connector	8
2.2. Status indicator	8
3. INSTALLING THE PDP002Z.....	9
4. CONNECTING TO THE NETWORK	10
4.1. Installation method	10
4.2. Setting a station address	11
5. COMMUNICATIONS-RELATED PARAMETERS.....	13
5.1. <i>F851</i> : Communication Loss Action Setting (Network breaks).....	14
5.2. <i>F852</i> : Preset speed operation selection.....	14
5.3. <i>F830</i> : PPO TYPE Setting	15
6. PROFIBUS LOCAL/REMOTE OPERATION	16
7. SPECIFICATIONS	17
8. WARRANTY	17

1. Overview

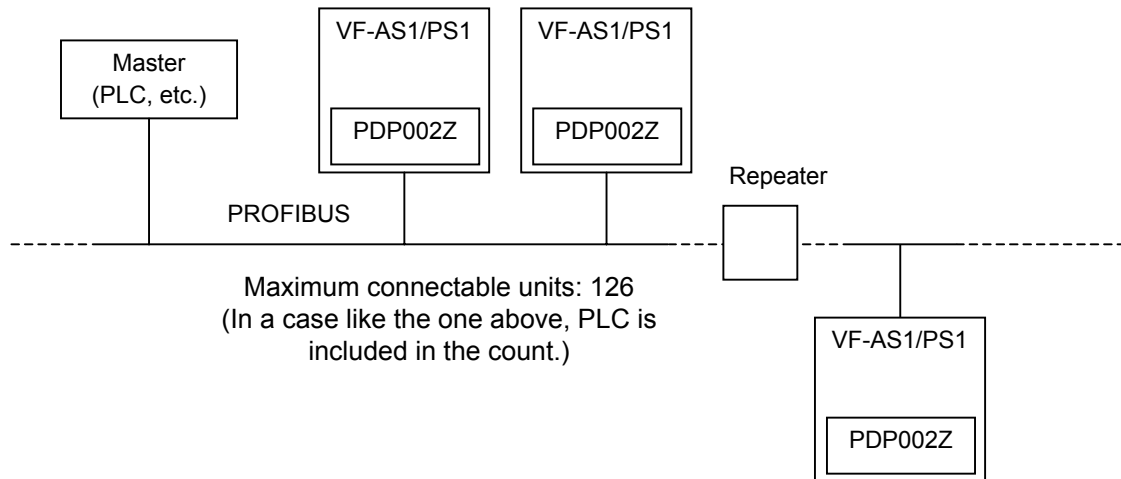

The PDP002Z option allows the VF-AS1/PS1 inverter to be connected as a slave (DP-V0) into a PROFIBUS network. Up to 126 stations* can be connected to the network (* including a master. If no repeater is provided, up to 32 stations can be connected to each segment).

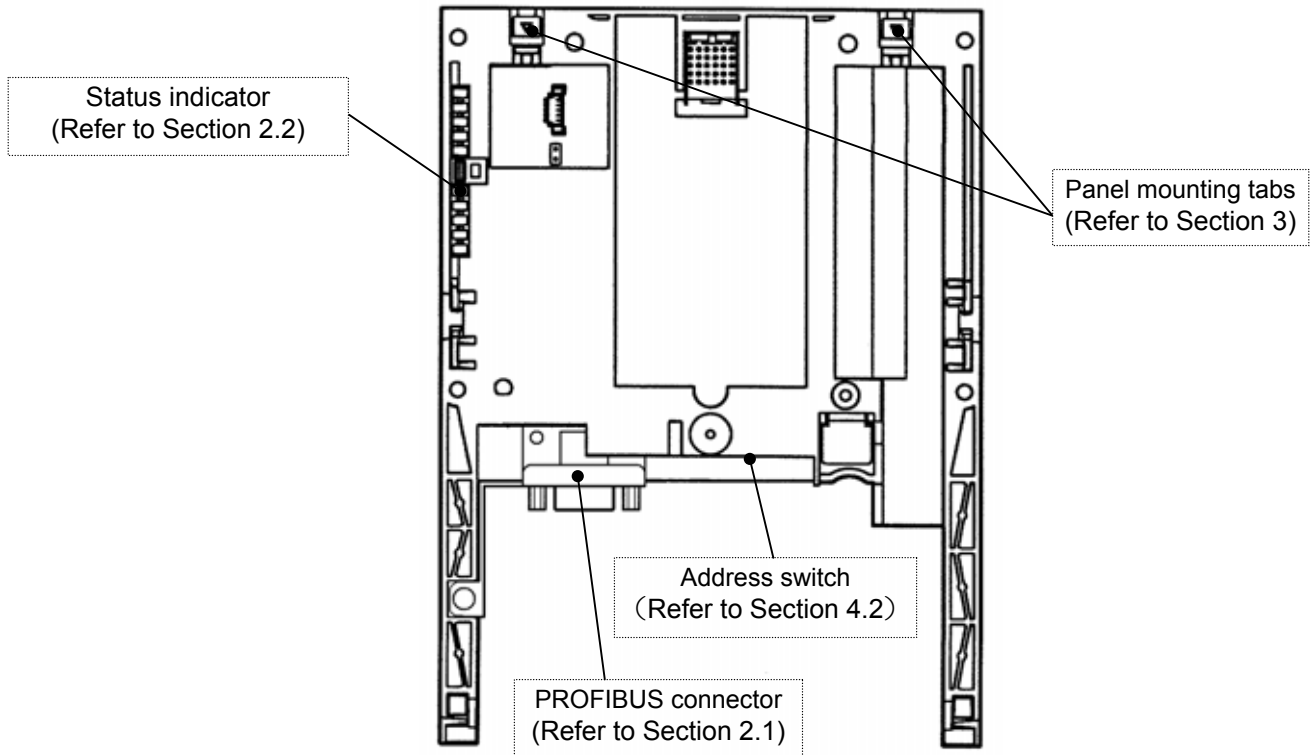

2. Exterior features

The external view of this option and the name of each part are shown below.



 Danger	
 Prohibited	<p>▼ Do not change the switch setting when the power is on. It could lead to electric shocks, or the option might breaks down or get damaged.</p>

2.1. PROFIBUS connector

Used to connect PROFIBUS network cables. The connector is a D-Sub connector with 9 pin female and the connector pin allocation described below follows the PROFIBUS standard.

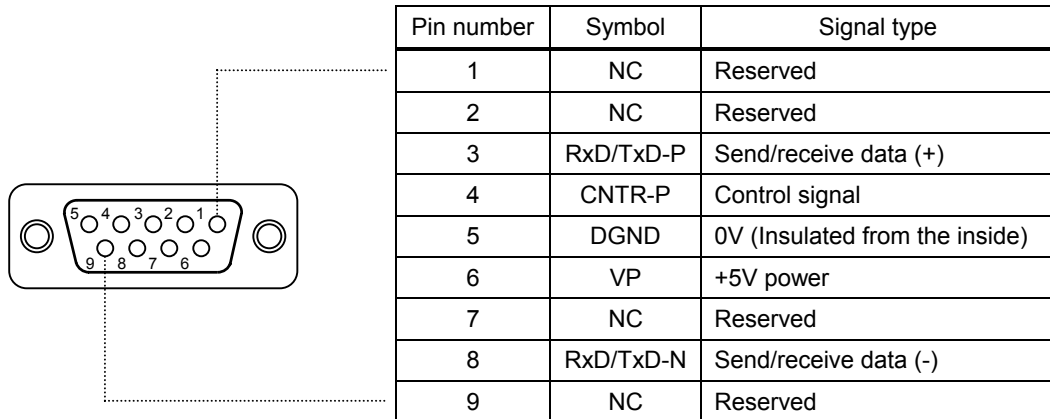

The PDP002Z has no termination resistor. Therefore, termination resistors need to be connected to the station on each side of the PROFIBUS network or the master, as shown in the figure below. (The PROFIBUS connector with termination resistor are recommended.)

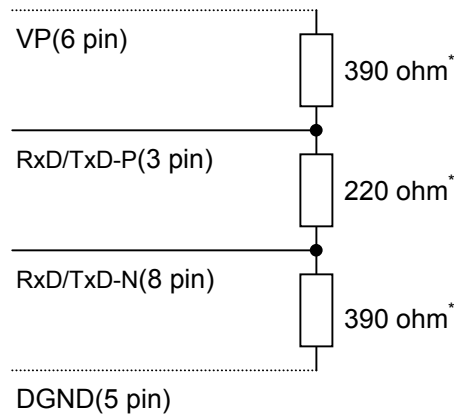

* 1/4W or more is recommended.

2.2. Status indicator

The PDP002Z has two LEDs, ST (status) and DX (data exchange) to indicate the statuses of PROFIBUS-DP and the PDP002Z itself.

ST (Status): Red LED

LED	Meanings
Off	No diagnostics present
Flashes	Waiting for parameterisation or configuration
Lights	DP status error * For example, a station address is not set correctly.

DX (Data exchange): Green LED.

Indicates the status of the PROFIBUS network.

It lights when the PDP002Z is on-line and data exchange is possible.

3. Installing the PDP002Z

Install the PROFIBUS option to VF-AS1/PS1 as follows:

* When this option is used together with the IO card option, attach this option to the front panel side.

- (1) Turn off input power of VF-AS1/PS1 and wait for at least 15 minutes and then check that the CHARGE lamp on VF-AS1/PS1 is no longer lit.
- (2) Securing the option to the inverter
 - a) Insert a flat-blade screwdriver in each of the two holes at the upper part of the front panel, release the panel mounting tab by pushing the screwdriver down, and remove the front panel cover.
 - b) Install the option in the inverter by fitting the tabs on the lower side of the option into the slots at the lower part of the inverter front panel.
 - c) Make sure the option is securely attached to the inverter. Then, check whether the plastic bosses on the inverter case have fitted in the holes at the upper and lower parts of the option.
 - d) Insert the tabs at the lower part of the front cover into the slots at the lower part of the inverter to attach the front cover to the inverter.
 - e) Stuck the enclosed "LED name label" on the option LED display part of a front cover.

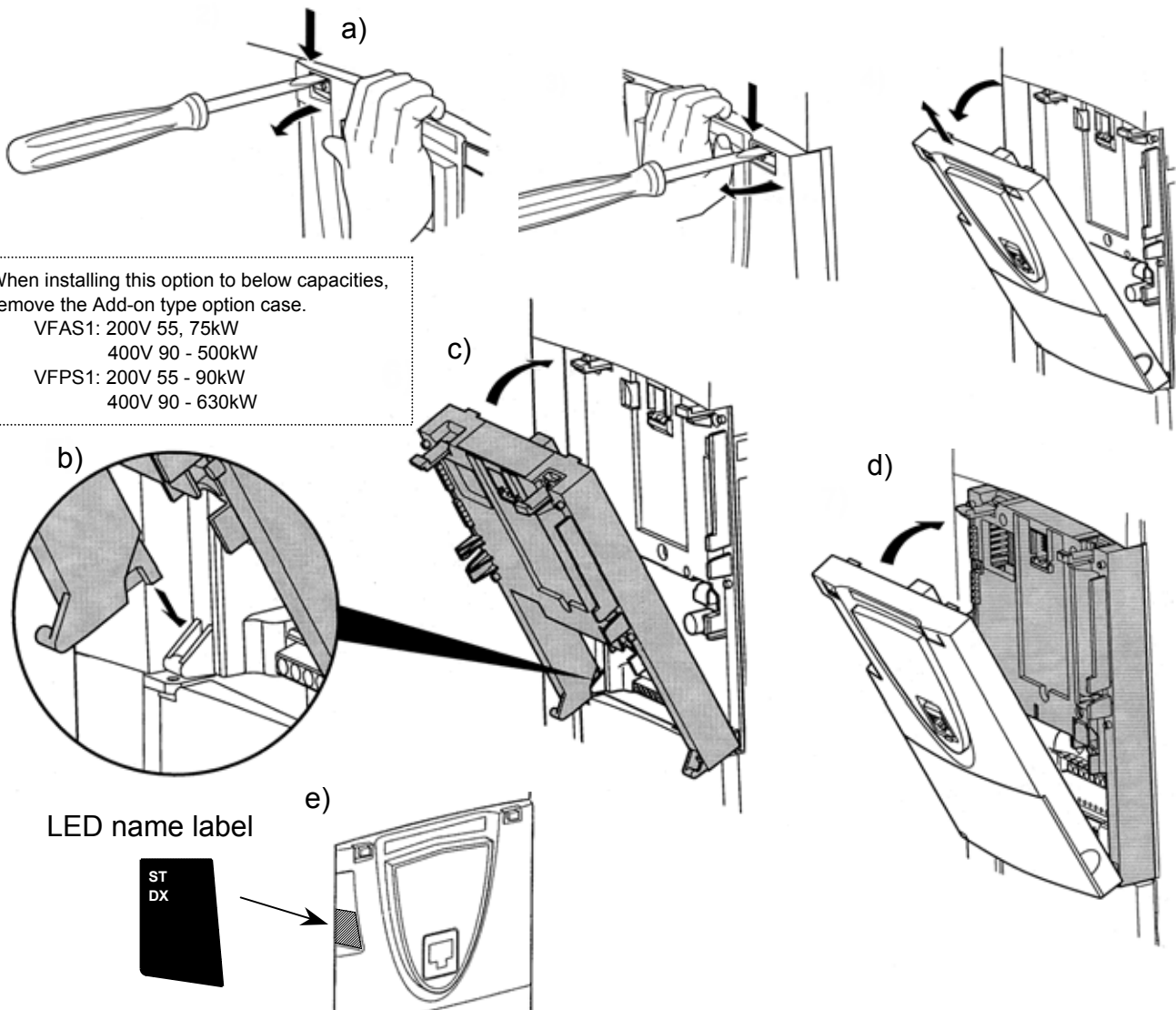

4. Connecting to the network

4.1. Installation method

- (1) Using the DIP switch on the PROFIBUS option, set a station address. (Refer to Section 4.2.)
- (2) Connect a PROFIBUS connector to the PDP002Z. (Refer to Section 2.1.)
 - * If the PDP002Z is located at an end of the bus, connect a terminal resistor to it.
(When using a connector with termination resistor, set it ON.)
- (3) Once all the parameters are set, the power must be cycled to the VF-AS1/PS1 for these changes to take effect. (Refer to Section 5.)

4.2. Setting a station address

The DIP switch on the circuit board of the option is used to set a station address. Each DIP switch is ON when it is flipped to the lower position. By default, it is factory-configured to 2.

The station address must be unique and not match any other device on the network.

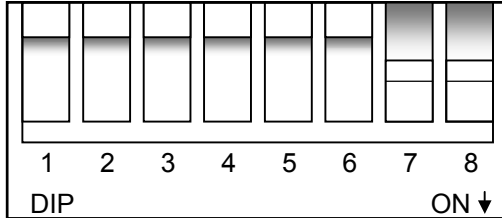

SW ID	1	2	3	4	5	6	7	8
0	OFF	OFF	OFF	OFF	OFF	OFF	OFF	OFF
1	OFF	OFF	OFF	OFF	OFF	OFF	OFF	ON
2	OFF	OFF	OFF	OFF	OFF	OFF	ON	OFF
3	OFF	OFF	OFF	OFF	OFF	OFF	ON	ON
4	OFF	OFF	OFF	OFF	OFF	ON	OFF	OFF
5	OFF	OFF	OFF	OFF	OFF	ON	OFF	ON
6	OFF	OFF	OFF	OFF	OFF	ON	ON	OFF
7	OFF	OFF	OFF	OFF	OFF	ON	ON	ON
8	OFF	OFF	OFF	OFF	ON	OFF	OFF	OFF
9	OFF	OFF	OFF	OFF	ON	OFF	OFF	ON
10	OFF	OFF	OFF	OFF	ON	OFF	ON	OFF
11	OFF	OFF	OFF	OFF	ON	OFF	ON	ON
12	OFF	OFF	OFF	OFF	ON	ON	OFF	OFF
13	OFF	OFF	OFF	OFF	ON	ON	OFF	ON
14	OFF	OFF	OFF	OFF	ON	ON	ON	OFF
15	OFF	OFF	OFF	OFF	ON	ON	ON	ON
16	OFF	OFF	OFF	ON	OFF	OFF	OFF	OFF
17	OFF	OFF	OFF	ON	OFF	OFF	OFF	ON
18	OFF	OFF	OFF	ON	OFF	OFF	ON	OFF
19	OFF	OFF	OFF	ON	OFF	OFF	ON	ON
20	OFF	OFF	OFF	ON	OFF	ON	OFF	OFF
21	OFF	OFF	OFF	ON	OFF	ON	OFF	ON
22	OFF	OFF	OFF	ON	OFF	ON	ON	OFF
23	OFF	OFF	OFF	ON	OFF	ON	ON	ON
24	OFF	OFF	OFF	ON	ON	OFF	OFF	OFF
25	OFF	OFF	OFF	ON	ON	OFF	OFF	ON
26	OFF	OFF	OFF	ON	ON	OFF	ON	OFF
27	OFF	OFF	OFF	ON	ON	OFF	ON	ON
28	OFF	OFF	OFF	ON	ON	ON	OFF	OFF
29	OFF	OFF	OFF	ON	ON	ON	OFF	ON
30	OFF	OFF	OFF	ON	ON	ON	ON	OFF
31	OFF	OFF	OFF	ON	ON	ON	ON	ON

SW ID	1	2	3	4	5	6	7	8
32	OFF	OFF	ON	OFF	OFF	OFF	OFF	OFF
33	OFF	OFF	ON	OFF	OFF	OFF	OFF	ON
34	OFF	OFF	ON	OFF	OFF	OFF	ON	OFF
35	OFF	OFF	ON	OFF	OFF	OFF	ON	ON
36	OFF	OFF	ON	OFF	OFF	ON	OFF	OFF
37	OFF	OFF	ON	OFF	OFF	ON	OFF	ON
38	OFF	OFF	ON	OFF	OFF	ON	ON	OFF
39	OFF	OFF	ON	OFF	OFF	ON	ON	ON
40	OFF	OFF	ON	OFF	ON	OFF	OFF	OFF
41	OFF	OFF	ON	OFF	ON	OFF	OFF	ON
42	OFF	OFF	ON	OFF	ON	OFF	ON	OFF
43	OFF	OFF	ON	OFF	ON	OFF	ON	ON
44	OFF	OFF	ON	OFF	ON	ON	OFF	OFF
45	OFF	OFF	ON	OFF	ON	ON	OFF	ON
46	OFF	OFF	ON	OFF	ON	ON	ON	OFF
47	OFF	OFF	ON	OFF	ON	ON	ON	ON
48	OFF	OFF	ON	ON	OFF	OFF	OFF	OFF
49	OFF	OFF	ON	ON	OFF	OFF	OFF	ON
50	OFF	OFF	ON	ON	OFF	OFF	ON	OFF
51	OFF	OFF	ON	ON	OFF	OFF	ON	ON
52	OFF	OFF	ON	ON	OFF	ON	OFF	OFF
53	OFF	OFF	ON	ON	OFF	ON	OFF	ON
54	OFF	OFF	ON	ON	OFF	ON	ON	OFF
55	OFF	OFF	ON	ON	OFF	ON	ON	ON
56	OFF	OFF	ON	ON	ON	OFF	OFF	OFF
57	OFF	OFF	ON	ON	ON	OFF	OFF	ON
58	OFF	OFF	ON	ON	ON	OFF	ON	OFF
59	OFF	OFF	ON	ON	ON	OFF	ON	ON
60	OFF	OFF	ON	ON	ON	ON	OFF	OFF
61	OFF	OFF	ON	ON	ON	ON	OFF	ON
62	OFF	OFF	ON	ON	ON	ON	ON	OFF
63	OFF	OFF	ON	ON	ON	ON	ON	ON

SW ID	1	2	3	4	5	6	7	8
64	OFF	ON	OFF	OFF	OFF	OFF	OFF	OFF
65	OFF	ON	OFF	OFF	OFF	OFF	OFF	ON
66	OFF	ON	OFF	OFF	OFF	OFF	ON	OFF
67	OFF	ON	OFF	OFF	OFF	OFF	ON	ON
68	OFF	ON	OFF	OFF	OFF	ON	OFF	OFF
69	OFF	ON	OFF	OFF	OFF	ON	OFF	ON
70	OFF	ON	OFF	OFF	OFF	ON	ON	OFF
71	OFF	ON	OFF	OFF	OFF	ON	ON	ON
72	OFF	ON	OFF	OFF	ON	OFF	OFF	OFF
73	OFF	ON	OFF	OFF	ON	OFF	OFF	ON
74	OFF	ON	OFF	OFF	ON	OFF	ON	OFF
75	OFF	ON	OFF	OFF	ON	OFF	ON	ON
76	OFF	ON	OFF	OFF	ON	ON	OFF	OFF
77	OFF	ON	OFF	OFF	ON	ON	OFF	ON
78	OFF	ON	OFF	OFF	ON	ON	ON	OFF
79	OFF	ON	OFF	OFF	ON	ON	ON	ON
80	OFF	ON	OFF	ON	OFF	OFF	OFF	OFF
81	OFF	ON	OFF	ON	OFF	OFF	OFF	ON
82	OFF	ON	OFF	ON	OFF	OFF	ON	OFF
83	OFF	ON	OFF	ON	OFF	OFF	ON	ON
84	OFF	ON	OFF	ON	OFF	ON	OFF	OFF
85	OFF	ON	OFF	ON	OFF	ON	OFF	ON
86	OFF	ON	OFF	ON	OFF	ON	ON	OFF
87	OFF	ON	OFF	ON	OFF	ON	ON	ON
88	OFF	ON	OFF	ON	ON	OFF	OFF	OFF
89	OFF	ON	OFF	ON	ON	OFF	OFF	ON
90	OFF	ON	OFF	ON	ON	OFF	ON	OFF
91	OFF	ON	OFF	ON	ON	OFF	ON	ON
92	OFF	ON	OFF	ON	ON	ON	OFF	OFF
93	OFF	ON	OFF	ON	ON	ON	OFF	ON
94	OFF	ON	OFF	ON	ON	ON	ON	OFF
95	OFF	ON	OFF	ON	ON	ON	ON	ON

SW ID	1	2	3	4	5	6	7	8
96	OFF	ON	ON	OFF	OFF	OFF	OFF	OFF
97	OFF	ON	ON	OFF	OFF	OFF	OFF	ON
98	OFF	ON	ON	OFF	OFF	OFF	ON	OFF
99	OFF	ON	ON	OFF	OFF	OFF	ON	ON
100	OFF	ON	ON	OFF	OFF	ON	OFF	OFF
101	OFF	ON	ON	OFF	OFF	ON	OFF	ON
102	OFF	ON	ON	OFF	OFF	ON	ON	OFF
103	OFF	ON	ON	OFF	OFF	ON	ON	ON
104	OFF	ON	ON	OFF	ON	OFF	OFF	OFF
105	OFF	ON	ON	OFF	ON	OFF	OFF	ON
106	OFF	ON	ON	OFF	ON	OFF	ON	OFF
107	OFF	ON	ON	OFF	ON	OFF	ON	ON
108	OFF	ON	ON	OFF	ON	ON	OFF	OFF
109	OFF	ON	ON	OFF	ON	ON	OFF	ON
110	OFF	ON	ON	OFF	ON	ON	ON	OFF
111	OFF	ON	ON	OFF	ON	ON	ON	ON
112	OFF	ON	ON	ON	OFF	OFF	OFF	OFF
113	OFF	ON	ON	ON	OFF	OFF	OFF	ON
114	OFF	ON	ON	ON	OFF	OFF	ON	OFF
115	OFF	ON	ON	ON	OFF	OFF	ON	ON
116	OFF	ON	ON	ON	OFF	ON	OFF	OFF
117	OFF	ON	ON	ON	OFF	ON	OFF	ON
118	OFF	ON	ON	ON	OFF	ON	ON	OFF
119	OFF	ON	ON	ON	OFF	ON	ON	ON
120	OFF	ON	ON	ON	ON	OFF	OFF	OFF
121	OFF	ON	ON	ON	ON	OFF	OFF	ON
122	OFF	ON	ON	ON	ON	OFF	ON	OFF
123	OFF	ON	ON	ON	ON	OFF	ON	ON
124	OFF	ON	ON	ON	ON	ON	OFF	OFF
125	OFF	ON	ON	ON	ON	ON	OFF	ON
126	OFF	ON	ON	ON	ON	ON	ON	OFF

5. Communications-related parameters

On the network, the VF-AS1/PS1 (including the PDP002Z) serves as a slave device. Using the parameters listed below, set the slave device on the network and its mode of operation.

The GSD files used to configure the PDP002Z can be downloaded from the following web site.

VF-AS1 <http://www.inverter.co.jp/product/inv/vfas1/pdp/>

VF-PS1 <http://www.inverter.co.jp/product/inv/vfps1/pdp/>

Parameter	Function	Adjustment range	Default setting
<i>F830*</i>	Communication option setting 1 (PPO TYPE)	0: None 1: PPO TYPE 1 2: PPO TYPE 2 3: PPO TYPE 3 4: PPO TYPE 4	0
<i>F851</i>	Inverter operation at the communications loss action (Network wire breaks)	0: Stop and break of connection 1: None 2: Deceleration stop 3: Coast stop 4: Emergency stop 5: Preset speed operation command (Operating at the preset speed operation frequency set with <i>F852</i>)	0
<i>F852</i>	Preset speed operation selection	0: None 1 to 15: Preset speed	0
<i>F853</i>	Monitoring of communication device station address	Displays the station address assigned with the DIP switch. 0 to 125	1
<i>F854**</i>	Monitoring of communications device's baud rate	Displays the network communication speed set with the DIP switch. 0: 12 Mbit/s 1: 6 Mbit/s 2: 3 Mbit/s 3: 1.5 Mbit/s 4: 500 kbit/s 5: 187.5 kbit/s 6: 93.75 kbit/s 7: 45.45 kbit/s 8: 19.2 kbit/s 9: 9.6 kbit/s 255: Disabled	0

* When the parameters are changed, the power must be cycled to the VF-AS1/PS1 for the changes to take effect.

** The baud rate of the PDP002Z is automatically set by configuration a baud rate for the master.

5.1. *F851*: Communication Loss Action Setting (Network breaks)

This parameter sets up the VF-AS1/PS1 response to a loss of communications with the PROFIBUS network. (On some occasions, the master side will need to be configured.)

0: Stop and break of connection

The inverter decelerates the motor to a stop and gives the L alarm.

Commands entered through the network are canceled, and the commands set with parameters $\text{L} \text{N} \text{O} \text{d}$ and $\text{F} \text{N} \text{O} \text{d}$ become effective.

When communications are restored, the L alarm is turned off.

1: None

The inverter remains in the state where it was when the problem arose, and it gives the L alarm.

2: Deceleration stop

The inverter decelerates the motor to a stop and gives the L alarm. Commands entered through the network are not canceled.

3: Coast stop

The inverter issues a command for a frequency of 0Hz and gives the L alarm.

Commands entered through the network are not canceled.

4: Emergency stop

The error message $\text{E} \text{r} \text{r} \text{B}$ is displayed. Commands entered through the network are not canceled.

When communications are restored, the inverter is not restored to working order and the error message $\text{E} \text{r} \text{r} \text{B}$ does not disappear until the inverter is reset.

5: Preset speed operation command

Refer to Section 5.2

5.2. *F852*: Preset speed operation selection

If the communication loss action (parameter *F851*) is set to 5 (preset speed command), the VF-AS1/PS1 will run at a preset speed as set up by this parameter in the case of a communication loss (with L alarm). Commands entered through the network are not canceled.

For example,

If the inverter is set as described below,

F851 = 5 (preset speed operation command)

F852 = 8 (preset speed operation frequency 8)

F287 (preset speed operation frequency 8) = 10 (10Hz)

Operation is carried out as follows.

Network	Operation of the VF-AS1/PS1
Normal conditions	Operates according to commands entered through the network.
↓	↓
communications loss	Operates at 10Hz.
↓	↓
Restoration.....	Operates according to commands entered through the network.

5.3. F830: PPO TYPE Setting

The PPO type of PDP002Z is set up by this parameter.

The PROFIBUS-DP protocol uses so-called PPOs (*Parameter/Process Data Objects*) in cyclic communication. The figures below show the PPO types and configurations that the PDP002Z supports.

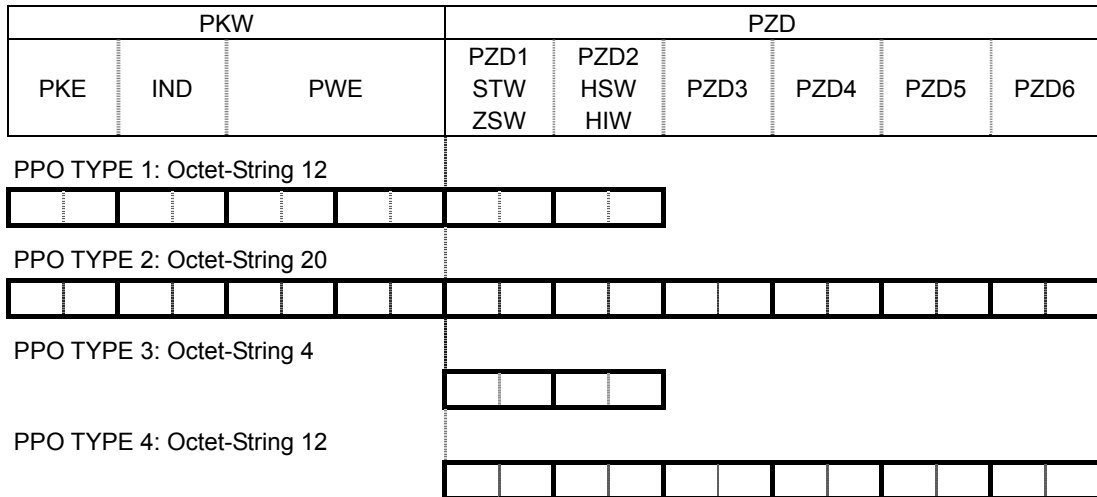

PKW : Parameter ID/value

PZD : Process Data, cyclically transferred

PKE : Parameter ID (1st and 2nd octet)

IND : Sub-index (3rd octet), 4th octet is reserved

PWE : Parameter value (5th until 8th octet)

STW : Control word

HSW : Main setpoint

ZSW : Status word

HIW : Main actual value

6.PROFIBUS Local/Remote Operation

The example below shows how to configure the VF-AS1/PS1 for local / remote operation.

<Terminal function>

F terminal RUN command

R terminal..... PROFIBUS/Local (Terminal in this example) switching

RR/S4 terminal.... Operation frequency command

<Wiring>

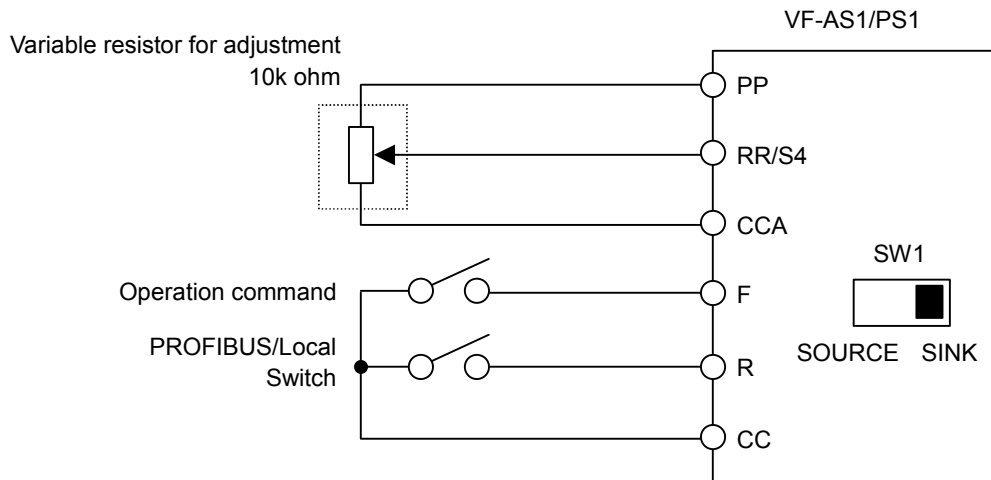

<Parameter setting>

\overline{CND} (command mode selection) = 0 (terminal board)

\overline{FND} (frequency setting mode selection 1) = 2 (RR/S4)

$\overline{F12}$ (input terminal selection 2 (R)) = 48 (PROFIBUS/Local control)

<Operation>

R-CC terminal open:

VF-AS1/PS1 is controlled as slave device of PROFIBUS.

R-CC terminal closed:

F-CC terminal short to RUN

F-CC terminal open to STOP

Output frequency is set up by the RR/S4 signal input.

7. Specifications

Item	Specifications
Model number	PDP002Z
Technical data	PROFIBUS DP-V0 PPO TYPE: 1 to 4 by No.3.072 Profile for Variable Speed Drives Connector: D-Sub 9 pin female Station address setting: DIP switch Baud rate: 9.6 kbps up to 12Mbps
Use environments	Indoors, an altitude of 3,000m or less, where the product will not be exposed to direct sunlight, corrosive or explosive gases, vapor, coarse particulates including dust, and where there is no grinding fluid or grinding oil nearby
Ambient temperature	-10 to +60°C
Storage temperature	-25 to +65°C
Relative humidity	20 to 93% (no condensation and absence of vapor)
Vibration	5.9m/s ² {0.6G} or less (10 - 55Hz)

8. Warranty

Any part of the inverter that proves defective will be repaired free of charge under the following conditions:

1. If and when a trouble occurs on the option unit properly installed and handled within one year of delivery, and if the trouble is clearly attributable to defects inherent in our design and manufacture, the product will be repaired free of charge.
2. This warranty applies only to the option unit.
3. For the following kinds of failure or damage, the repair cost shall be borne by the customer even within the warranty period.
 - 1) Failure or damage caused by improper or incorrect use or handling, or unauthorized repair or modification of the option.
 - 2) Failure or damage caused by the option falling or an accident during transportation after the purchase.
 - 3) Failure or damage caused by fire, salty water or wind, corrosive gas, earthquake, storm or flood, lightning, abnormal voltage supply, or other natural disasters.
 - 4) Damage sustained as a result of the fact that the product was used for any application other than that designated for the PROFIBUS option (circuit board) for the VF-AS1/PS1.
4. If terms and conditions of warranty are otherwise specified, priority is given to them.