

Moeller HPL0213-2004/2005

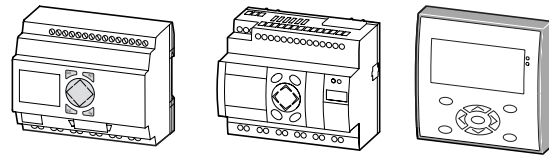

	Page
System overview	
easy control relays	8/4
easy control relay, MFD multi-function display	8/14
Description	
Networking via easy-NET	8/6
easy control relays	
Base units	8/7
Expansion units	8/11
MFD multi-function-displays	
Display/operating unit	8/16
Power supply/CPU modules	8/16
I/O modules	8/17
Accessories	
easy control relays	8/18
MFD multi-function displays	8/20
Technical data	
easy control relays	8/21
MFD multi-function displays	8/40
Dimensions	8/48



The SIMPLE Way to Signalling, Operating, Switching, Open-Loop and Closed-Loop Control, and Communication



It is all the same, whether used in residential buildings, commercial buildings, in machine or instrumentation construction, or elsewhere, whether fitted in a control panel, an insulated enclosure or a service distribution board, whether AC or DC operated, with transistor output or 8 A relay output, – one of the easy control relays will fit the bill. You simply input your circuit diagram 1:1 into the device as an easy wiring configuration or with the aid of the EASY-SOFT software that supports you in all the functions on the PC. You can read the current flow path of your circuit diagram immediately on the device or the PC. This active current flow display saves valuable time. What is more, the menu language can be changed to suit local requirements. The applications of the easy control relay range from simple control relay and timing relay control systems, via analog value processing to networked systems with high-speed counters, PID loop controllers with analog output or PWM output.



Lighting control systems in buildings:

- The lighting can be switched On and Off using a current surge function centrally or as a distributed function.
- The timer-controlled interrupt pulse can switch Off the lighting to save power.
- A base unit controls up to 12 independent lighting groups. Purpose-dedicated lighting control, such as central lighting for cleaning work, automatic half-strength lighting for stair wells, or an early warning pulse for the lights-out phase can be configured.
- Installation in low-voltage distribution boards facilitated by the standard 45mm front dimension, as well as the component sizes of 4 times, 6 times, 8 times and 12 times the width of an MCB.

Machine control:

- A plug-in memory module enables the easy circuit diagram to be duplicated without the PC. Subsequently necessary modifications to the circuit can be carried out externally, and the memory module dispatched to transfer the modification to the easy.
- The fact that you can pre-set the start-up behaviour to operating modes RUN or STOP facilitates commissioning.
- Short-circuit recognition and selective disconnection of the transistor outputs upon short circuit and overload.



easy500 Control Relay

8 digital inputs, 4 relay or 4 transistor outputs. 2 of the 8 inputs can be used as analog inputs with easy..-AB.., -DA.., -DC.. types.
 2 high-speed and 2 frequency counters each of 8 inputs with easy..-DA, and ..-DC. 128 current paths for series and parallel connection of contacts and coils. Three contacts and one coil in series. Display of 16 operator or alarm texts internally or externally. Main functions are: multifunction timing relay, impulse relay, counters (up- and down, high-speed, frequency, hours-run); analog value comparator, weekly and annual timers. Automatic changeover summer/winter time. Retentive actual values of markers, counters, timing relays.

easy700 Control Relay

12 digital inputs, 6 relay or 8 transistor outputs. 4 of the 12 inputs can be used as analog inputs with easy..-AB.., -DA.., -DC.. types.
 2 high-speed and 2 frequency counters each of 12 inputs with easy..-DA, and ..-DC. 128 current paths for series and parallel connection of contacts and coils. Three contacts and one coil in series. Display of 16 operator or alarm texts internally or externally. In addition to centralized or remote expandability, easy 700 can be linked to standardized bus systems. easy700 offers the same functions as easy500.

Easy800 Control Relay

12 digital inputs, 6 relay or 8 transistor outputs. 4 of the 12 inputs on DC devices can be used for analog values, as frequency counters, high-speed counters and incremental value counters. 256 current paths for series and parallel connection of contacts and coils. Four contacts and one coil in series. Display of 32 operator or alarm texts internally or externally. easy 800 can be expanded like easy700.
 Eight easy800 or MFD-Titan can be networked via easyNET. In addition to the easy700 functions, easy800 offers PID loops, arithmetic modules, value scaling and much more.

System Overview

easy Control Relays, MFD-Titan Multi-Function Displays

easy Control Relays, MFD

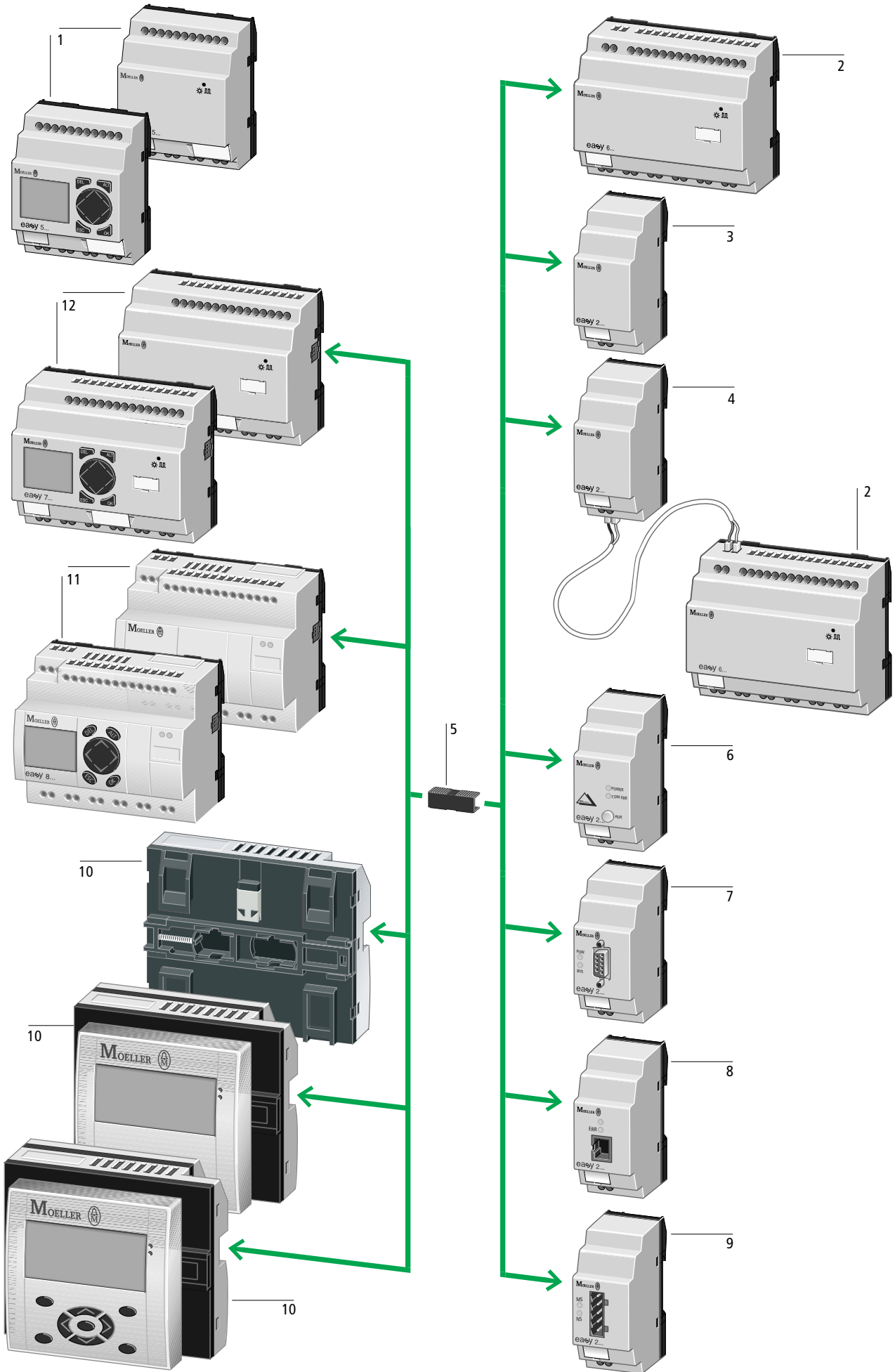

easy Control Relays, MFD-Titan Multi-Function Displays

Moeller HPL 0213-2004/2005

Base units, easy512	1
AC or DC operated	
Power supply	
AB 24 V AC	
AC 100 (115) – 240 V AC, 50/60 Hz	
DC 24 V DC	
DA 12 V DC	
8 digital inputs	
(2 inputs usable as analog inputs [all AB, DA and DC versions])	
4 relay outputs (max. 10 A)	
4 transistor outputs	
LCD display, X versions without LCD	
Bolt-on and top-hat rail mounting	
Connection via screw terminals	

→ 8/7

Base units, expandable easy719/721	12
AC or DC operated	
Supply voltage	
AB 24 V AC	
AC 100 – 240 V AC, 50/60 Hz	
DA 12 V DC	
DC 24 V DC	
12 digital inputs	
(4 inputs usable as analog inputs [all AB, DA and DC versions])	
6 relay outputs (max. 10 A)	
8 transistor outputs	
LCD display, X versions without LCD	
Bolt-on and top-hat rail mounting	
Connection via screw terminals	

→ 8/7

Base units, expandable easy819/822	11
AC or DC operated	
Supply voltage	
AC 100 – 240 V, 50/60 Hz	
DC 24 V DC	
12 digital inputs	
(4 inputs usable as analog inputs [all DC versions])	
6 relay outputs (max. 10 A)	
8 transistor outputs	
1 analog output (optional on DC versions)	
LCD display, X versions without LCD	
All DC versions with high-speed counters, frequency counters and incremental counters	
Bolt-on and top-hat rail mounting	
Connection via screw terminals	
Network easy-NET built in	

→ 8/7

Expansion units	2
Input/output expansion	
AC or DC operated	
Supply voltage	
AC 100 – 240 V AC, 50/60 Hz	
DC 24 V DC	
12 digital inputs	
6 relay outputs (max. 10 A)	
8 transistor outputs	
Bolt-on and top-hat rail mounting	
Connection via screw terminals	

→ 8/11

MFD-Titan multi-function display, expandable	10
AC or DC operated	
Supply voltage	
AC 100 – 240 V AC, 50/60 Hz	
DC 24 V DC	
12 digital inputs	
(4 inputs usable as analog inputs [all DC versions])	
4 relay outputs (max. 10 A)	
4 transistor outputs	
1 analog output (optional on DC versions)	
LCD display, full graphics, monochrome	
Bolt-on and top-hat rail mounting	
(2 × 22.5 mm, display fastened using 2 threaded fixing rings)	
Spring-loaded terminals	
Network easy-NET built in	

→ 8/16

Expansion unit	3
EASY202-RE	
Output expansion	
2 relay outputs (max. 10 A)	
Bolt-on and top-hat rail mounting	
Connection via screw terminals	

→ 8/11

Coupling unit	4
EASY200-EASY	
For the remote connection of an easy6... expansion unit via 2-pole connecting cable (max. 30 m)	
e.g. NYM 3 × 1.5 mm ²	

→ 8/11

EASY-LINK-DS data plug	5
For connecting the base unit with the expansion unit (ordering only necessary if required for replacement, since this is supplied with each expansion unit)	

→ 8/18

Network connections	6
EASY205-ASI	
AS-Interface connection as slave	

→ 8/11

Network connections	7
EASY204-DP	
PROFIBUS DP connection as slave	

→ 8/11

Network connections	8
EASY221-CO	
CANopen connection (in preparation for easy800, MFD)	

→ 8/11

Network connections	9
EASY222-DN	
DeviceNet connection (in preparation for easy800, MFD)	
PROFIBUS DP connection as slave	

→ 8/11

Features of easy control relay, MFD-Titan

- Extensive range of operating temperatures -25 °C/+55 °C
- Standard front dimension for mounting in service distribution boards, 18 mm space unit
- Electronic wiring by key stroke, LCD and keypad or via software (PC)
- Zero-voltage safe internal and external circuit configuration storage in EEPROM memory
- 3 contacts (easy500, easy700), 4 contacts (easy800, MFD-Titan) as make contacts or break contacts in series plus one coil per current path
- Series and parallel connection
- 128 current paths (easy500, easy700)
- 256 current paths (easy800, MFD)
- Integral password protection for circuit configuration and relay and parameter value presets
- Current flow display for checking the circuit configuration (LCD types)
- Menu guidance in 12 languages (easy500, easy700) or 10 languages (easy800, MFD) : English, German, French, Italian, Spanish, Portuguese, Dutch, Swedish, Polish, Turkish, (Czech, Hungarian)
- Circuit configuration can be saved on memory card with LCD types (X versions: read only)

Functions

- 16 timing relays 0.01 s to 99 h 59 min (easy500, easy700)
- 32 timing relays 0.005 s to 99 h 59 min (easy800, MFD)
 - On-delayed (optionally: random switching)
 - Off-delayed (optionally: random switching)
 - On-delayed and Off-delayed (optionally: random switching) pulse shaping
 - Flashing
- 16 counting relays (easy500, easy700) up-, down counting, 00000 to 32000
- 32 counting relays (easy800, MFD)
 - Up-, down counting, value range ±2³¹
 - 2 high-speed counters (easy500, easy700)
 - Max. 1 kHz, optionally instead of standard counter
 - 4 high-speed counters (easy800, MFD)
 - Max. 5/3 kHz
 - 2 frequency counters (easy500, easy700)
 - Max. 1 kHz, optionally instead of standard counter
 - 2 incremental value counters (easy800, MFD)
 - Max. 3 kHz
 - 4 hours-run counters
 - Super-retentive saving of hours-run value (e.g. even at change of program)
 - 8 weekly timers (easy500, easy700)
 - 32 weekly timers (easy800, MFD)
 - 4 channels per timer, each channel offers one On/Off time
 - 8 annual timers (easy500, easy700)
 - 32 annual timers (easy800, MFD)
 - 4 channels per timer, each channel offers one On/Off time
 - 16 analog value comparators (easy500, easy700)
 - 32 analog value comparators (easy800, MFD)
 - Range: 0 – 10 V DC
 - Resolution: 10 Bit (1024 increments)
 - 16 freely editable text displays (easy500, easy700)
 - 4 × 12 characters, editable via EASY-SOFT
 - 32 freely editable text displays (easy800)
 - 4 × 16 characters, editable via EASY-SOFT
 - 32 markers or auxiliary relays (easy500, easy700)
 - 96 markers or auxiliary relays (easy800, MFD)
 - 32 arithmetic modules (easy800, MFD)
 - Functions: ADD, SUB, MUL, DIV
 - 32 Boolean functions (easy800)
 - Functions: AND, OR, NOT
 - Retentive actual values (easy500, easy700)
 - 16 markers, 6 timing relays, 8 counters
 - 4 hours-run counters, super-retentive
 - Retentive actual values (easy800, MFD)
 - 200 Bytes possible, data = MB (Marker Bytes) Function blocks = C; CF; CH; CI; DB; T i. e. 80 MB and up to 40 modules depending on storage space requirement
 - 4 hours-run counters, super-retentive



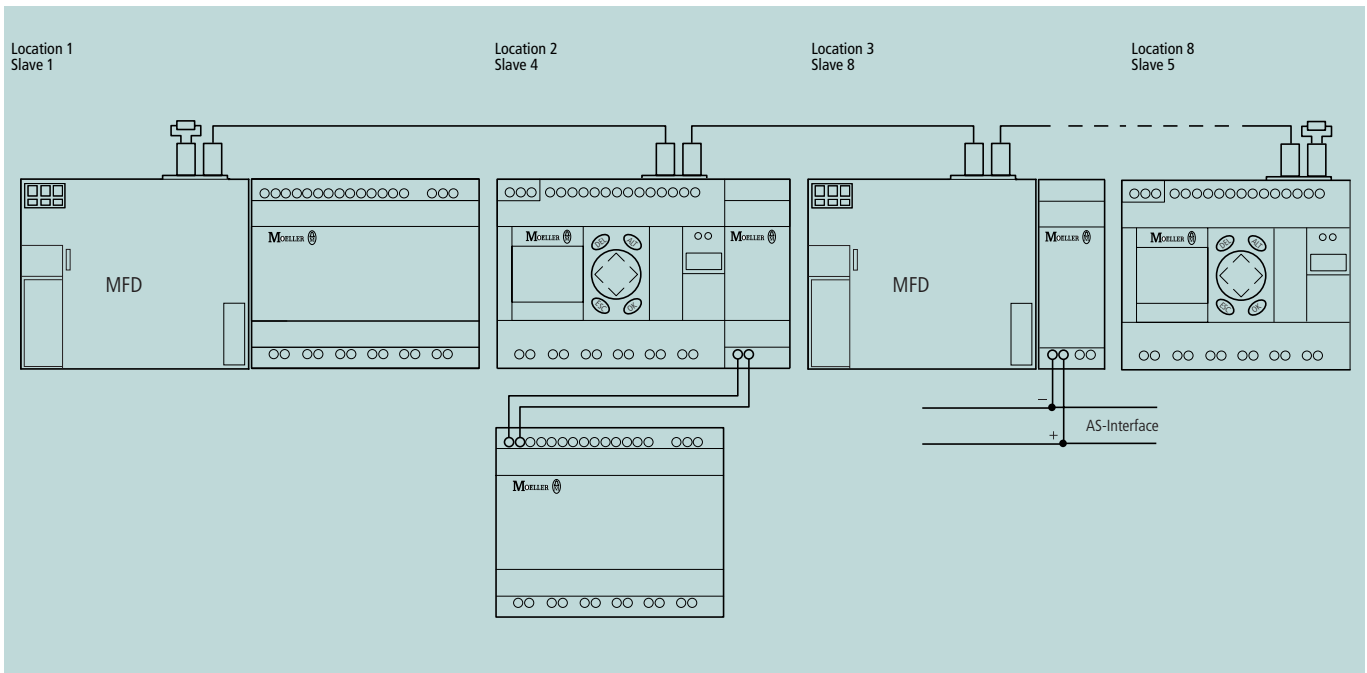

Networking

Addressing the slaves:

When all slaves are connected, the addresses can be assigned automatically, each slave number being assigned on the basis of geographical location. Slaves can also be addressed individually. The geographical address does not have to match the slave address.

Example of a network topology:

4 slaves are interconnected. Slave address 1 is always the first location. All the other slave addresses do not correspond to the geographical location.

Technical data

- A total of 320 digital inputs and outputs are possible
- 8 slaves
- Baud rate: 10 kBit/s to 1000 kBit/s
- Length: up to 1000 m possible
- Operating modes.
 - 1 master (location 1, slave address 1) and 7 intelligent slaves up to
 - 1 master (location 1, slave address 1) and 7 intelligent slaves
- Transfer of up to 32 double words
- Synchronization of time, date
- Direct access to inputs/outputs
- Program down- and upload via easy-NET

Change

The familiar and highly successful easy control relays of the easy400 and easy600 series, are now becoming even more efficient, versatile and quick. In order to advertise this new efficiency to the user externally too, the type references were modified accordingly.

The easy400 series became the improved series: easy500. Correspondingly, the easy600 series became the improved series: easy700. All the devices are fully downwards compatible. This means that all the already created circuit diagrams and programs can be transferred to and used on the new devices without any changes being necessary.

The following table shows the existing type references with the corresponding new ones and relevant Article numbers:

Previous Type	Previous Article no.	New Type	New Article no.
EASY412-AC-R	202405	EASY512-AC-R	274103
EASY412-AC-RC	202406	EASY512-AC-RC	274104
EASY412-AC-RCX	212308	EASY512-AC-RCX	274105
EASY412-DA-RC	224471	EASY512-DA-RC	274106
EASY412-DA-RCX	268232	EASY512-DA-RCX	274107
EASY412-DC-R	202403	EASY512-DC-R	274108
EASY412-DC-RC	202404	EASY512-DC-RC	274109
EASY412-DC-RCX	221596	EASY512-DC-RCX	274110
EASY412-DC-TC	207808	EASY512-DC-TC	274111
EASY412-DC-TCX	212307	EASY512-DC-TCX	274112
EASY619-AC-RC	218721	EASY719-AC-RC	274115
EASY619-AC-RCX	212312	EASY719-AC-RCX	274116
EASY619-DC-RC	224473	EASY719-DC-RC	274119
EASY619-DC-RC	224474	EASY719-DC-RCX	274120
EASY621-DC-TC	218719	EASY721-DC-TC	274121
EASY621-DC-TCX	212311	EASY721-DC-TCX	274122

Moeller HPL0213-2004/2005

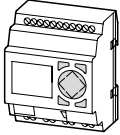
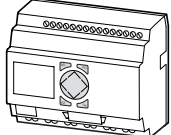
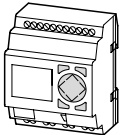
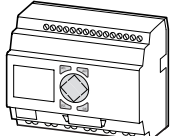
Description	Type Article no.	Price See Price List	Std. pack
Base units			
24 V AC			
 <ul style="list-style-type: none"> • 8 digital inputs (2 inputs available as analog inputs) • 4 relay outputs • LCD display • Operating buttons • Screw terminals • Timer 	EASY512-AB-RC 274101		1 off
 <p>Features same as EASY512-AB-RC, without keypad and LCD display</p>	EASY512-AB-RCX 274102		
<ul style="list-style-type: none"> • 12 digital inputs (4 inputs available as analog inputs) • 6 relay outputs • LCD display • Operating buttons • Screw terminals • Timer • Can be expanded using easy expansion units 	EASY719-AB-RC 274113		
<p>Features same as EASY719-AB-RC, without keypad and LCD display</p>	EASY719-AB-RCX 274114		
115/230 V AC			
 <ul style="list-style-type: none"> • 8 digital inputs • 4 relay outputs • LCD display • Operating buttons • Screw terminals 	EASY512-AC-R 274103		1 off
<p>Features same as EASY512-AC-R, with additional timer</p>	EASY512-AC-RC 274104		
 <p>Features same as EASY512-AC-RC, without keypad and LCD display</p>	EASY512-AC-RCX 274105		
<ul style="list-style-type: none"> • 12 digital inputs • 6 relay outputs • LCD display • Operating buttons • Screw terminals • Timer • Can be expanded using easy expansion units 	EASY719-AC-RC 274115		
<p>Features same as EASY719-AC-RC, without keypad and LCD display</p>	EASY719-AC-RCX 274116		
<ul style="list-style-type: none"> • 12 digital inputs • 6 relay outputs • LCD display • Operating buttons • Screw terminals • Timer • Can be expanded using easy expansion units • Network easy-NET 	EASY819-AC-RC 256267		
<p>Features same as EASY819-AC-RC, without keypad and LCD display</p>	EASY819-AC-RCX 256268		

easy Control Relays, MFD



Notes

Real-time clock back-up (only for devices with real-time clock)

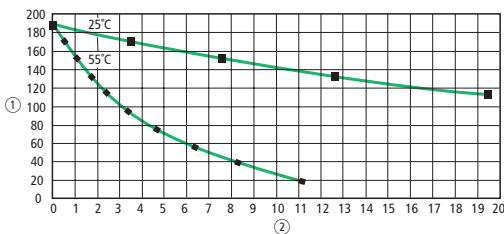

- ① Back-up time (hours)
- ② Service life (years)

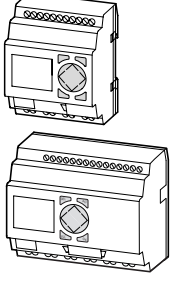
Description	Type Article no.	Price See Price List	Std. pack	
Base units				
12 V DC				
 <ul style="list-style-type: none"> • 8 digital inputs (2 inputs available as analog inputs) • 4 relay outputs • LCD display • Operating buttons • Screw terminals • Timer 	EASY512-DA-RC 274106		1 off	
	Features same as EASY512-DA-RC, without keypad and LCD display	EASY512-DA-RCX 274107		
	<ul style="list-style-type: none"> • 12 digital inputs (4 inputs available as analog inputs) • 6 relay outputs • LCD display • Operating buttons • Screw terminals • Timer • Can be expanded using easy expansion units 	EASY719-DA-RC 274117		
	Features same as EASY719-DA-RC, without keypad and LCD display	EASY719-DA-RCX 274118		

Notes

Real-time clock back-up (only for devices with real-time clock)

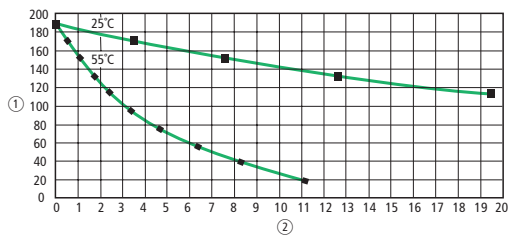

① Back-up time (hours)

② Service life (years)



Moeller HPL0213-2004/2005

Description	Type Article no.	Price See Price List	Std. pack
Base units			
24 V DC			
	<ul style="list-style-type: none"> • 8 digital inputs (2 inputs available as analog inputs) • 4 relay outputs • LCD display • Operating buttons • Screw terminals 	EASY512-DC-R 274108	1 off
	Features same as EASY512-DC-R, with additional timer	EASY512-DC-RC 274109	
	Features same as EASY512-DC-RC, without keypad and LCD display	EASY512-DC-RCX 274110	
	<ul style="list-style-type: none"> • 8 digital inputs (2 inputs available as analog inputs) • 4 transistor outputs • LCD display • Operating buttons • Screw terminals • Timer 	EASY512-DC-TC 274111	
	Features same as EASY512-DC-TC, without keypad and LCD display	EASY512-DC-TCX 274112	
	<ul style="list-style-type: none"> • 12 digital inputs (4 inputs available as analog inputs) • 6 relay outputs • LCD display • Operating buttons • Screw terminals • Timer • Can be expanded using easy expansion units 	EASY719-DC-RC 274119	
	Features same as EASY719-DC-RC, without keypad and LCD display	EASY719-DC-RCX 274120	
	<ul style="list-style-type: none"> • 12 digital inputs (4 inputs available as analog inputs) • 8 transistor outputs • LCD display • Operating buttons • Screw terminals • Timer • Can be expanded using easy expansion units 	EASY721-DC-TC 274121	
	Features same as EASY721-DC-TC, without keypad and LCD display	EASY721-DC-TCX 274122	
	<ul style="list-style-type: none"> • 12 digital inputs (4 inputs available as analog inputs) • 6 relay outputs • LCD display • Operating buttons • Screw terminals • Timer • Can be expanded using easy expansion units • Network easy-NET 	EASY819-DC-RC 256269	
	Features same as EASY819-DC-RC, without keypad and LCD display	EASY819-DC-RCX 256270	

easy Control Relays, MFD



Notes

Real-time clock back-up (only for devices with real-time clock)

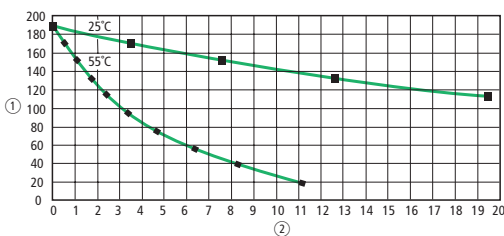

- ① Back-up time (hours)
- ② Service life (years)

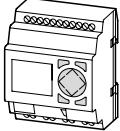
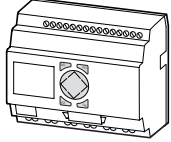
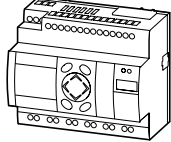
Description	Type Article no.	Price See Price List	Std. pack
Base units			
24 V DC			
 <ul style="list-style-type: none"> • 12 digital inputs (4 inputs available as analog inputs) • 6 relay outputs • 1 analog output • LCD display • Operating buttons • Screw terminals • Timer • Can be expanded using easy expansion units • Network easy-NET 	EASY820-DC-RC 256271		1 off
 <p>Features same as EASY820-DC-RC, without keypad and LCD display</p>	EASY820-DC-RCX 256272		
 <ul style="list-style-type: none"> • 12 digital inputs (4 inputs available as analog inputs) • 8 transistor outputs • LCD display • Operating buttons • Screw terminals • Timer • Can be expanded using easy expansion units • Network easy-NET 	EASY821-DC-TC 256273		
<p>Features same as EASY821-DC-TC, without keypad and LCD display</p>	EASY821-DC-TCX 256274		
<ul style="list-style-type: none"> • 12 digital inputs (4 inputs available as analog inputs) • 8 transistor outputs • 1 analog output • LCD display • Operating buttons • Screw terminals • Timer • Can be expanded using easy expansion units • Network easy-NET 	EASY822-DC-TC 256275		
<p>Features same as EASY822-DC-TC, without keypad and LCD display</p>	EASY822-DC-TCX 256276		
<p>Customized with company logo inscription, programmed with user program</p>	EASY-COMBINATION-* 257823		

Notes

Real-time clock back-up (only for devices with real-time clock)

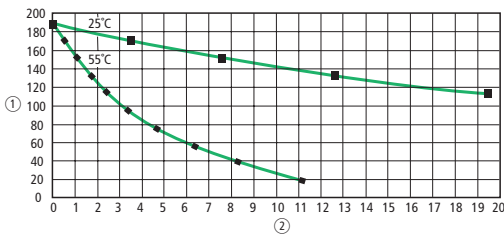

- ① Back-up time (hours)
- ② Service life (years)



Moeller HPL0213-2004/2005

Description	Type Article no.	Price See Price List	Std. pack
Expansion units			
115/230 V AC			
<ul style="list-style-type: none"> • 12 digital inputs • 6 relay outputs 	EASY618-AC-RE 212314		1 off
24 V DC			
<ul style="list-style-type: none"> • 12 digital inputs • 6 relay outputs 	EASY618-DC-RE 232112		1 off
<ul style="list-style-type: none"> • 12 digital inputs • 8 transistor outputs 	EASY620-DC-TE 212313		1 off
Without power supply			
<ul style="list-style-type: none"> • 2 relay outputs (common potential) (Not for use in combination with EASY719-DA-... base units) 	EASY202-RE 232186		1 off
Coupling unit			
<ul style="list-style-type: none"> • Gateway for coupling with a base unit: easy700, easy800, MFD-Titan • Terminals for remote expansion, up to 30 m to/from the expansion unit 	EASY200-EASY 212315		1 off
Expansion units for networking			
AS-Interface			
<ul style="list-style-type: none"> • AS-Interface connection • Slave • 4 inputs, 4 outputs, 4 parameter bits • Addresses available: 0 to 31 	EASY205-ASI 221598		1 off
PROFIBUS DP			
<ul style="list-style-type: none"> • PROFIBUS DP slave • Addresses available: 1 to 126 	EASY204-DP 212316		1 off
CANopen			
<ul style="list-style-type: none"> • CANopen interface • Addresses available: 1 to 127 	EASY221-CO 233539		1 off
DeviceNet			
<ul style="list-style-type: none"> • DeviceNet interface • Addresses available: 0 to 63 	EASY222-DN 233540		1 off



Indication, Closed-Loop Control, Open-Loop Control and Communication – Simply Use MFD-Titan®



The MFD-Titan multi-function display shows graphics and standard message texts, date, time and 7-segment digits with equally brilliant clarity. Setpoint values are input directly at the MFD-Titan. This fully graphics-capable back-lit display impresses by its attractive style with IP65 degree of protection. To install it into the panel door, you simply attach it through two 22.5 mm drilled holes. You snap-fit the power supply/CPU modules and inputs/outputs from the rear. – And it's done.

Now you have all the possibilities of the easy800 control relay and an HMI at your fingertips. We even inscribe the front of the unit with your own designation, – by laser, so that it does not rub off.



New operator and control concept for textile machines

The newly enhanced machine series from Meyer presents the market with innovative fixing and setting machines. It was MFD-Titan that enabled all these improvements. The new safety concept increases reliability and also simplifies the operator's job. All the functions can be set up as it were intuitively, and can be readjusted if necessary on an ergonomically designed and generously proportioned operator interface.

MFD-Titan is a product that belongs to the next generation in automation, combining as it does control and visualisation functions in one unit. It requires just one software package for the control function, the visualisation and networking. This fact significantly reduced the time that had to be spent on engineering and programming by the machine builder, Meyer.

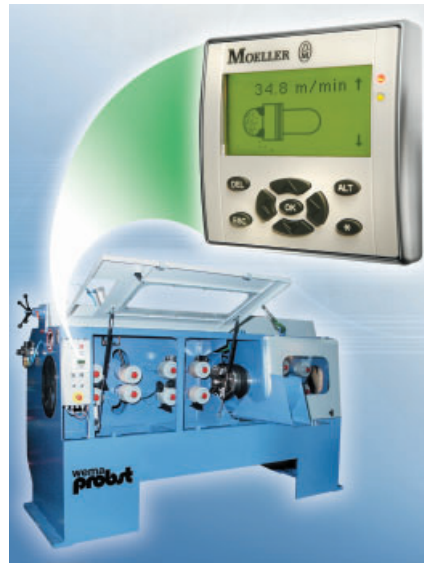

Modular control concept for profiling systems

The machine building company, Wema Probst, relies on the performance capability of MFD-Titan and EASY800 for its new soft-wood profiling system. The new multifunction display as it were, incorporates the networking facility. This benefits the machine builder as well as his customer. Wema Probst is a successful specialist builder of machines and systems for soft-wood processing. Wema Probst's construction principle firstly equips each part of the system with an autonomously operating control system. In the case of a complete installation being supplied, these individual control systems are then networked and controlled as a system. Operation and monitoring of the installation is carried out from one MFD-Titan.

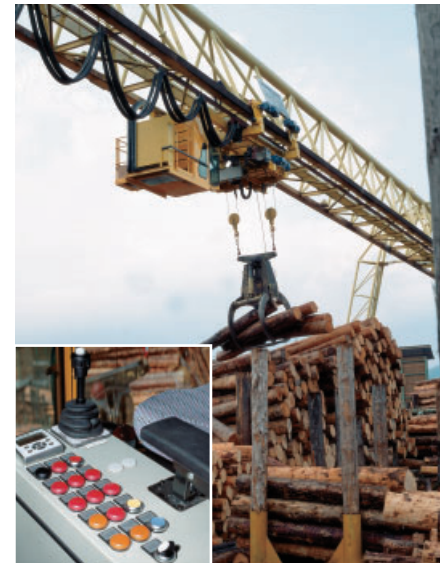

Control engineering for a crane installation

The MFD-Titan in the control cabin functions as operator interface: In addition to allowing centralised visualisation of fault messages from individual network stations, the display also indicates their operational status. A menu enables the operator furthermore to call up graphics showing speeds, limit switch positions, operational hours run and schedules for maintenance.

The MFD-Titan networked with the easy control relay can together deal with the following tasks and functions:
 Single and double lifting gear mode
 Highly precise synchronisation control
 Lifting operation interruption
 Selective load measuring
 Linear field-weakening
 Dynamically adapted control procedures
 Softstart and softstop
 Load independent travel
 Configurable setpoint channels

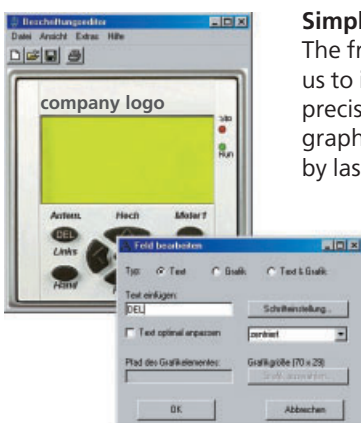

Simply laser-inscribed to order

The freely available inscription software enables us to inscribe function keys and enclosures ex-factory, precisely to your requirements. Texts, as well as graphics, such as your own logo, can be applied by laser.



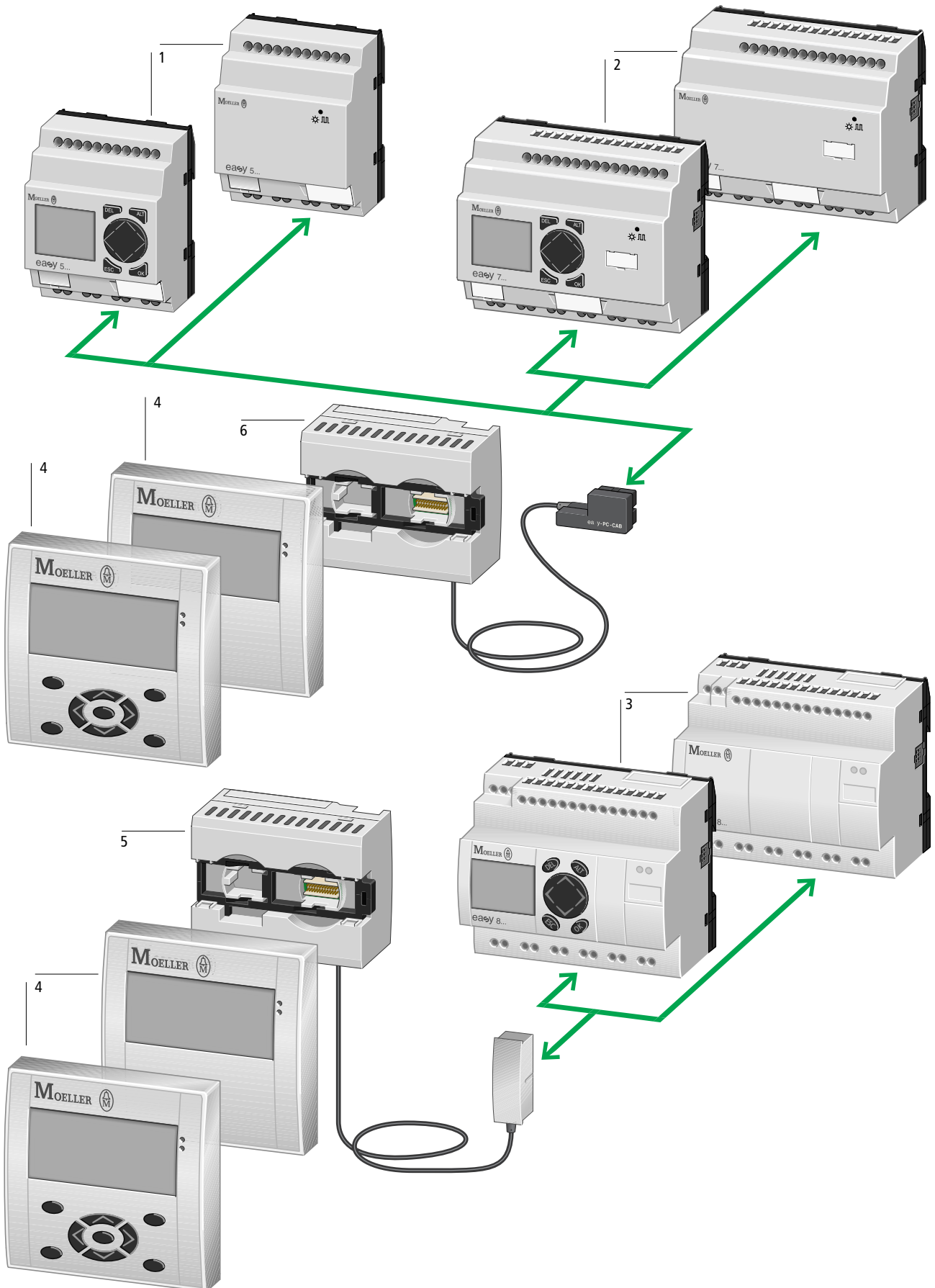

easy Control Relays, MFD-Titan Multi-Function Displays

Moeller HPL0213-2004/2005

Power supply unit/communication module	6
MFD-CP4-500	
Supply voltage: 24 V DC	
Serial interface	
Spring-loaded terminals	
Programming port connection to easy500/easy700 as display repeater with MFD-80-... (ASCII characters)	
With integral extension cable (5 m, can be cut to length)	

→ 8/17

MFD-Titan multi-function display, expandable	4
AC or DC operated	
Supply voltage	
AC 100 – 240 V AC, 50/60 Hz	
DC 24 V DC	
12 digital inputs (4 inputs usable as analog inputs [all DC versions])	
4 relay outputs (max. 10 A)	
4 transistor outputs	
1 analog output (optional on DC versions)	
LCD display, full graphics, monochrome	
Bolt-on and top-hat rail mounting (2 × 22.5 mm, display fastened using 2 threaded fixing rings)	
Spring-loaded terminals	
Network easy-NET built in	

→ 8/16

Base units, easy512	1
AC or DC operated	
Power supply	
AB 24 V AC	
AC 100 (115) – 240 V AC, 50/60 Hz	
DC 24 V DC	
DA 12 V DC	
8 digital inputs (2 inputs usable as analog inputs [all AB, DA and DC versions])	
4 relay outputs (max. 10 A)	
4 transistor outputs	
LCD display, X versions without LCD	
Bolt-on and top-hat rail mounting	
Connection via screw terminals	

→ 8/7

Power supply unit/communication module	5
MFD-CP4-800	
Supply voltage: 24 V DC	
Serial interface	
Spring-loaded terminals	
Programming port connection to easy800/MFD..CP8-.. as display repeater with MFD-80-... (ASCII characters)	
With integral extension cable (5 m, can be cut to length)	

→ 8/17

Base units, expandable easy719/721	2
AC or DC operated	
Supply voltage	
AB 24 V AC	
AC 100 – 240 V AC, 50/60 Hz	
DA 12 V DC	
DC 24 V DC	
12 digital inputs (4 inputs usable as analog inputs [all AB, DA and DC versions])	
6 relay outputs (max. 10 A)	
8 transistor outputs	
LCD display, X versions without LCD	
Bolt-on and top-hat rail mounting	
Connection via screw terminals	

→ 8/7

Base units, expandable easy819/822	3
AC or DC operated	
Supply voltage	
AC 100 – 240 V, 50/60 Hz	
DC 24 V DC	
12 digital inputs (4 inputs usable as analog inputs [all DC versions])	
6 relay outputs (max. 10 A)	
8 transistor outputs	
1 analog output (optional on DC versions)	
LCD display, X versions without LCD	
All DC versions with high-speed counters, frequency counters and incremental counters	
Bolt-on and top-hat rail mounting	
Connection via screw terminals	
Network easy-NET built in	

→ 8/7

Features of easy control relay, MFD-Titan

- Extensive range of operating temperatures -25 °C/+55 °C
- Standard dimensions for mounting in service distribution boards, 18 mm space unit
- Electronic wiring by key stroke, LCD and keypad or via software (PC)
- Zero-voltage safe internal and external circuit configuration storage in EEPROM-memory
- 3 contacts (easy500, easy700), 4 contacts (easy800, MFD) as make contacts or break contacts in series plus one coil per current path
- Series and parallel connection
- 128 current paths (easy500, easy700)
- 256 current paths (easy800, MFD)
- Integral password protection for circuit configuration and relay and parameter value presets
- Current flow display for checking the circuit configuration (LCD types)
- Menu guidance in 12 languages (easy500, easy700) or 10 languages (easy800, MFD) : English, German, French, Italian, Spanish, Portuguese, Dutch, Swedish, Polish, Turkish, (Czech, Hungarian)
- Circuit configuration can be saved on memory card with LCD types (X versions: read only)

Functions

- 16 timing relays 0.01 s to 99 h 59 min (easy500, easy700)
- 32 timing relays 0.005 s to 99 h 59 min (easy800, MFD)
 - On-delayed (optionally: random switching)
 - Off-delayed (optionally: random switching)
 - On-delayed and Off-delayed (optionally: random switching)
 - Single pulse
 - Flashing
- 16 counting relays (easy500, easy700)
 - Up-, down counting, 00000 to 32000
- 32 counting relays (easy800, MFD)
 - Up-, down counting, value range ±2³¹
- 2 high-speed counters (easy500, easy700)
 - Max. 1 kHz, optionally instead of standard counter
- 4 high-speed counters (easy800, MFD)
 - Max. 5/3 kHz
- 2 frequency counters (easy500, easy700)
 - Max. 1 kHz, optionally instead of standard counter
- 2 incremental value counters (easy800, MFD)
 - Max. 3 kHz
- 4 hours-run counters
 - Super-retentive saving of hours-run value (e.g. even at change of program)
- 8 weekly timers (easy500, easy700)
- 32 weekly timers (easy800, MFD)
 - 4 channels per timer, each channel offers one On/Off time
- 8 annual timers (easy500, easy700)
- 32 annual timers (easy800, MFD)
 - 4 channels per timer, each channel offers one On/Off time
- 16 analog value comparators (easy500, easy700)
- 32 analog value comparators (easy800, MFD)
 - Range: 0 – 10 V DC
 - Resolution: 10 Bit (1024 increments)
- 16 freely editable text displays (easy500, easy700)
 - 4 × 12 characters, editable via EASY-SOFT
- 32 freely editable text displays (easy800)
 - 4 × 16 characters, editable via EASY-SOFT
- 32 markers or auxiliary relays (easy500, easy700)
- 96 markers or auxiliary relays (easy800, MFD)
- 32 arithmetic modules (easy800, MFD)
 - Functions: ADD, SUB, MUL, DIV
- 32 Boolean functions (easy800)
 - Functions: AND, OR, NOT
- Retentive actual values (easy500, easy700)
 - 16 markers, 6 timing relays, 8 counters
 - 4 hours-run counters, super-retentive
- Retentive actual values (easy800, MFD)
 - 200 Bytes possible, data = MB (Marker Bytes) function blocks = C; CF; CH; CI; DB; T i. e. 80 MB and up to 40 modules depending on storage space requirement
 - 4 hours-run counters, super-retentive

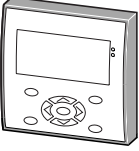
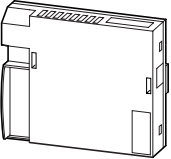

Description	Type Article no.	Price See Price List	Std. pack	
Multi-function display				
Display/operating unit IP65, NEMA 4x, Removable Titan front frame				
 <p>Graphics display: 132 × 64 pixels Switchable backlight Freely definable status LEDs red + green Customized laser inscription via MFD-Combination-*</p>	MFD-80 265250		1 off	
	MFD-80-B 265251		1 off	
Individual laser inscription Only for MFD-80/B				
Inscription effected via the inscription editor in EASY-SOFT-PRO or by downloading the inscription editor only from → www.moeller.net	MFD-COMBINATION-* 265260		1 off	
Power supply/CPU modules IP20, cage clamp terminals				
 <p>115/230 V AC</p> <p>Serial interface I/O modules and easy expansions connectable</p> <p>Serial interface I/O modules and easy expansions connectable Network easy-NET</p>	MFD-AC-CP8-ME 274091		1 off	
	MFD-AC-CP8-NT 274092		1 off	
	24 V DC	MFD-CP8-ME 267164		1 off
		MFD-CP8-NT 265253		1 off

Notes
The MFD-Titan multi-function display can be run in the following configurations:
Power supply unit/CPU
Power supply unit/CPU + I/O modules
Power supply unit/CPU + display and operating unit
Power supply unit/CPU + display and operating unit + I/O modules
Power supply unit/communication modules + display and operating unit

Real-time clock back-up (only for devices with real-time clock)

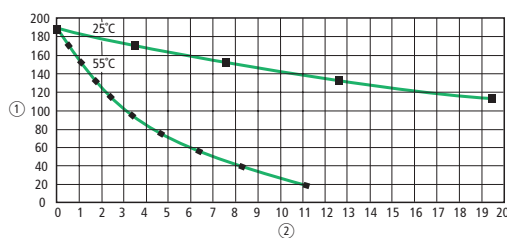

- ① Back-up time (hours)
- ② Service life (years)

Moeller HPL0213-2004/2005

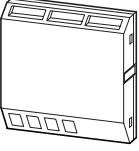
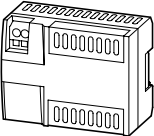
Description	Type Article no.	Price See Price List	Std. pack
Multi-function display			
I/O modules IP20, cage clamp terminals			
	115/230 V AC 12 digital inputs 4 relay outputs For MFD-AC-CP8...	MFD-AC-R16 274093	1 off
	24 V DC 12 digital inputs (4 inputs available as analog inputs) 4 relay outputs For MFD-CP8...	MFD-R16 265254	1 off
	12 digital inputs (4 inputs available as analog inputs) 4 transistor outputs For MFD-CP8...	MFD-T16 265255	1 off
	12 digital inputs (4 inputs available as analog inputs) 4 relay outputs 1 analog output For MFD-CP8...	MFD-RA17 265364	1 off
	12 digital inputs (4 inputs available as analog inputs) 4 transistor outputs 1 analog output For MFD-CP8...	MFD-TA17 265256	1 off
Power supply unit/communication modules IP20, cage clamp terminals			
	24 V DC Serial interface Programming port connection to easy500/easy700 as display repeater with MFD-80.. (ASCII characters) With integral connecting cable (5 m, can be cut to length)	MFD-CP4-500 274094	1 off
	24 V DC Serial interface Programming port connection to easy800/MFD-...-CP8-... as display repeater with MFD-80.. (ASCII characters) With integral connecting cable (5 m, can be cut to length)	MFD-CP4-800 274095	1 off

Notes

The MFD-Titan multi-function display can be run in the following configurations:
 Power supply unit/CPU
 Power supply unit/CPU + I/O modules
 Power supply unit/CPU + display and operating unit
 Power supply unit/CPU + display and operating unit + I/O modules
 Power supply unit/communication modules + display and operating unit

Real-time clock back-up (only for devices with real-time clock)

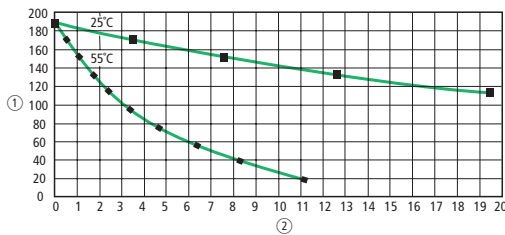

- ① Back-up time (hours)
- ② Service life (years)



Description	Type Article no.	Price See Price List	Std. pack
Accessories			
Software			
Programming and operating software CD, menu selection in 7 languages, installation on WIN NT 4.0 SP6 and higher, WIN2000, WIN XP			
Basic version of EASY-SOFT for easy400/500/600/700	EASY-SOFT-BASIC 284545		1 off
EASY-SOFT for easy400/600/800, (additionally, installation possible on WIN98, WIN ME)	EASY-SOFT 202407		1 off
Professional version, as EASY-SOFT, additionally programming and visualization of MFD-Titan.	EASY-SOFT-PRO 266040		1 off
Memory card			
32k module for saving the entire easy program for easy500, easy700.	EASY-M-32K 270884		1 off
256k module for saving the entire easy program for easy800 and MFD-Titan.	EASY-M-256K 256279		1 off
PC programming cable			
Length: 2m, for connection to 9-pole serial PC interface with interface electronics for easy500 and easy700	EASY-PC-CAB 202409		1 off
Length: 2m, for connection to 9-pole serial PC interface with interface electronics for easy800 and MFD-Titan	EASY800-PC-CAB 256277		1 off
Input/output simulator			
Simulator with 115/230 V AC plug-in power supply unit/24 V DC output, suitable for easy500-DC	EASY412-DC-SIM 212318		1 off
As EASY412-DC-SIM with 120 V AC plug-in power supply unit/24 V DC output, plug suitable for North America	EASY412-DC-SIM-NA 222566		1 off
Fixing bracket For screw fixing to mounting plate			
For screw fixing to mounting plate 3 fixing brackets per easy400, 500, 600, 700, 800 2 brackets per EASY2... 3 fixing brackets per MFD-CP8..., MFD-AC-CP8...	ZB4-101-GF1 061360		9 off
Coupling piece			
Spare link between base unit and expansion units	EASY-LINK-DS 221607		1 off
Telescopic clip			
With 35mm top-hat rail to IEC/EN 60715 for mounting depth compensation when rear mounting in CI-K... enclosures and cabinets. Steplessly adjustable via scales from 75 to 115 mm. Screw and snap fixing (also suitable for PKZM0, FAZ, FIP, ETR, EMR4 etc.)	M22-TA 226161		1 off
Switched-mode power supply unit Primary-switched mode, regulated			
Rated input voltage: 50/60 Hz: 115/230 V Rated output voltage: 24 V/12 V DC Rated output current: 0.25 A/20 A	EASY200-POW 229424		1 off
Rated input voltage: 50/60 HZ: 115/230 V AC Rated output voltage (residual ripple): 24 V DC (± 3 %) Rated output current: 1.25 A	EASY400-POW 212319		1 off
Series connected device To increase the AC input current			
6 channels	EASY256-HCI 231168		1 off

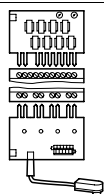

Moeller HPL0213-2004/2005

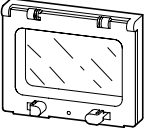
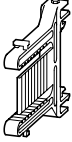
Description	Type Article no.	Price See Price List	Std. pack
Accessories			
Network connecting cable (remote coupling) to easy-NET, fully prepared for easy800, MFD-AC-CP8-NT and MFD-CP8-NT			
Length: 0.3 m	EASY-NT-30 256283		1 off
Length: 0.8 m	EASY-NT-80 256284		1 off
Length: 1.5 m	EASY-NT-150 256285		1 off
Data cable			
4-core 4 × 0.14 mm ² , twisted pair, AWG 26 Length: 100 m	EASY-NT-CAB 256286		1 off
Remote coupling			
Bus connection plug for easy-NET network, 8-pole, RJ45	EASY-NT-RJ45 256280		10 off
Bus termination resistor, complete with plug for easy-NET network	EASY-NT-R 256281		2 off
Crimping tool for 8-pole plug, RJ45	EASY-RJ45-TOOL 256282		1 off
Hinged inspection window (SKF) • Mounting frame with hinged window • Material: transparent polycarbonate, UV-resistant • Self-extinguishing to ASTM-D 635/72, UNE 53 315-75, UNE 20 672/83 (2-1) and IEC-695-2-1 • Degree of protection IP65 to IEC-144 and 525			
 94 mm × 77 mm × 25 mm (4 space units)	SKF-FF4 233780		1 off
130 mm × 77 mm × 25 mm (6 space units)	SKF-FF6 233781		1 off
Top-hat rail adapter for hinged inspection window			
 12 mm × 66 mm × 82 mm Installation on hinged inspection window, for front fitting of devices. Complete set, consisting of 2 brackets and 4 screws	SKF-HA 233782		1 off
PROFIBUS DP bus connector plug			
Pins, 9-pole Cable entry, angled by 90°	ZB4-209-DS2 206982		1 off
Metallised insulated housing Maximum transfer rate 12 MBit/s Integrated switch (accessible from the outside) for the bus terminating resistors Terminal block for two cable entries, with straight or 90° angled cable entry, as required Suitable for EASY204-DP	ZB4-209-DS3 217820		1 off
PROFIBUS DP data cable			
Twisted pair, without plug, 2 × 0.64 mm ² (only suitable for fixed wiring)	ZB4-900-KB1 206983		100 m

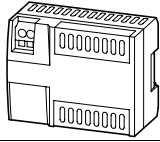

Description	Type Article no.	Price See Price List	Std. pack
Accessories			
Protective cover, transparent For MFD-Titan multi-function display			
Can be turned through $4 \times 90^\circ$ Sealing facility for protection against accidental actuation (without RMQ-Titan front frame)	MFD-XS-80 265259		1 off
Transparent version for harsh environmental conditions and application in the food industry (with RMQ-Titan front frame)	MFD-XM-80 265258		1 off
Point-to-point connecting cable, serial interfaces For connecting MFD-Titan to easy800 or MFD-Titan to MFD-Titan			
2 m long, made up	MFD-800-CAB 265257		1 off
5 m long, can be prepared as required, with separate plug	MFD-800-CAB5 266041		1 off
Mounting rail to EN 50022 for MFD-AC-CP8.../MFD-CP8...			
Mounting rail with cutout specifically for MFD-AC-CP8.../MFD-CP8... for fixing easy expansion units (2 space units) Length: 142.5 mm	MFD-TS-144 274090		1 off
Stand-by power supply unit/communication module 24 V DC, IP20			
 Spare part for power supply unit/communication module MFD-CP4-500/MFD-CP4-800 with-out connecting cable Serial interface Programming port connection to easy500/easy700/easy800/MFD-...-CP8.. as display repeater with MFD-80.. (ASCII characters)	MFD-CP4 280888		1 off
Spare connecting cables			
Spare point-to-point connecting cable for connection of MFD-CP4-500 to easy500/easy700 5 m, can be cut to length	MFD-CP4-500-CAB5 280886		1 off
Replacement point-to-point connecting cable for connection of MFD-CP4-800 to easy800/MFD-...-CP8... 5 m, can be cut to length	MFD-CP4-800-CAB5 280887		1 off

Language	Type Article no.	Price See Price List	Std. pack	Notes
Documentation				
Manual for control relays easy500 and easy700				
German	AWB2528-1508D 278499		1 off	Other languages in preparation.
English	AWB2528-1508GB 278500		1 off	Other languages in preparation.
Manual for control relay easy800				
German	AWB2528-1423D 261371		1 off	Other languages in preparation.
English	AWB2528-1423GB 262671		1 off	Other languages in preparation.
Manual for the MFD-Titan				
German	AWB2528-1480D 267187		1 off	Other languages in preparation.
English	AWB2528-1480GB 267188		1 off	Other languages in preparation.

Notes Download of AWA2528-2019 from www.moeller.net

Moeller HPL0213-2004/2005

				EASY200-EASY EASY202-RE	EASY512-...
General technical data					
Standards				EN 55011, EN 55022, EN 61000-4, IEC 60068-2-6, IEC 60068-2-27	
Dimensions (W × H × D)			mm	35.5 × 90 × 58 (2 space units)	71.5 × 90 × 58 (4 space units)
Weight			kg	0.07	0.2
Mounting				Top-hat rail IEC/EN 60715, 35 mm or screw fixing using fixing brackets ZB4-101-GF1 (accessories)	
Terminal capacity					
Solid			mm ²	0.2/4 (AWG 22 – 12)	0.2/4 (AWG 22 – 12)
Flexible with ferrule			mm ²	0.2/2.5 (AWG 22 – 12)	0.2/2.5 (AWG 22 – 12)
Standard screwdriver			mm	3.5 × 0.8	3.5 × 0.8
Max. tightening torque			Nm	0.6	0.6
Ambient climatic conditions					
Operational ambient temperature			°C	–25/+55, low temperatures to IEC 60068-2-1, high temperatures to IEC 60068-2-2	
Condensation				Prevent condensation by means of suitable measures	
LCD display (clearly legible)			°C	0 – 55	0 – 55
Storage			°C	40 – 70	40 – 70
Relative humidity, non-condensing (IEC/EN 60068-2-30)			%	5 – 95	5 – 95
Atmospheric pressure (operation)			hPa	795 – 1080	795 – 1080
Corrosion resistance					
IEC/EN 60947-2-42		4 days SO ₂	cm ³ /m ³	10	10
IEC/EN 60068-2-43		4 days H ₂ S	cm ³ /m ³	1	1
Ambient mechanical conditions					
Pollution degree				2	2
Degree of protection (IEC/EN 60529)				IP20	IP20
Vibrations (IEC/EN 60068-2-6)					
Constant amplitude 0.15 mm			Hz	10 – 57	10 – 57
Constant acceleration, 2 g			Hz	57 – 150	57 – 150
Mechanical shock resistance (IEC/EN 60068-2-27) semi-sinusoidal 15 g/11 ms			Impacts	18	18
Drop to IEC/EN 60068-2-31		Drop height	mm	50	50
Free fall, packaged (IEC/EN 60068-2-32)			m	1	1
Mounting position				Horizontal/vertical	Horizontal/vertical
Electromagnetic compatibility (EMC)					
Electrostatic discharge (IEC/EN 61000-4-2, Level 3, ESD)					
Air discharge			kV	8	8
Contact discharge			kV	6	6
Electromagnetic fields (IEC/EN 61000-4-3, RFI)			V/m	10	10
Radio interference suppression (EN 55011)				EN 55011 Class B, EN 55022 Class B	
Burst pulses (IEC/EN 61000-4-4, level 3)					
Supply cables			kV	2	2
Signal lines			kV	2	2
High-energy pulses (surge) (IEC/EN 61000-4-5)			kV	2 (supply cables, symmetrical, EASY...AC)	
High-energy pulses (surge) (IEC/EN 61000-4-5, level 2)			kV	0.5 (supply cables, symmetrical, EASY...DC)	
Immunity to line-conducted interference to (IEC/EN 61000-4-6)			V	10	10
Insulation resistance					
Clearance in air and creepage distances				EN 50178, UL 508, CSA C22.2, No. 142	
Insulation resistance				EN 50178	EN 50178
Back-up/Accuracy of the real-time clock					
Back-up of real-time clock				–	→ Page 5
Accuracy of the real-time clock				–	Normally ± 5 (± 0.5 h/year)
Repetition accuracy of timing relays					
Accuracy of timing relays (of values)			%	–	± 1
Resolution					
Range "S"			ms	–	10
Range "M:S"			s	–	1
Range "H:M"			min	–	1
Retentive memory					
Write cycles of the retentive memory (at least)				–	1000000 (10 ⁶)

Notes

For additional Technical Data EASY5... and EASY7... → AWB2528-1508GB, EASY8... → AWB2528-1423GB



			EASY6...EASY7...	EASY8...-...
General technical data				
Standards			EN 55011, EN 55022, EN 61000-4, IEC 60068-2-6, IEC 60068-2-27	
Dimensions (W × H × D)		mm	107.5 × 90 × 58 (6 space units)	107.5 × 90 × 72 (6 space units)
Weight		kg	0.3	0.3
Mounting			Top-hat rail IEC/EN 60715, 35 mm or screw fixing using fixing brackets ZB4-101-GF1 (accessories)	
Terminal capacity				
Solid		mm ²	0.2/4 (AWG 22 – 12)	0.2/4 (AWG 22 – 12)
Flexible with ferrule		mm ²	0.2/2.5 (AWG 22 – 12)	0.2/2.5 (AWG 22 – 12)
Standard screwdriver		mm	3.5 × 0.8	3.5 × 0.8
Max. tightening torque		Nm	0.6	0.6
Ambient climatic conditions				
Operational ambient temperature		°C	–25/+55, low temperatures to IEC 60068-2-1, high temperatures to IEC 60068-2-2	
Condensation			Prevent condensation by means of suitable measures	
LCD display (clearly legible)		°C	0 – 55	0 – 55
Storage		°C	40 – 70	40 – 70
Relative humidity, non-condensing (IEC/EN 60068-2-30)		%	5 – 95	5 – 95
Atmospheric pressure (operation)		hPa	795 – 1080	795 – 1080
Corrosion resistance				
IEC/EN 60947-2-42	4 days SO ₂	cm ³ /m ³	10	10
IEC/EN 60068-2-43	4 days H ₂ S	cm ³ /m ³	1	1
Ambient mechanical conditions				
Pollution degree			2	2
Degree of protection (IEC/EN 60529)			IP20	IP20
Vibrations (IEC/EN 60068-2-6)				
Constant amplitude 0.15 mm		Hz	10 – 57	10 – 57
Constant acceleration, 2 g		Hz	57 – 150	57 – 150
Mechanical shock resistance (IEC/EN 60068-2-27) semi-sinusoidal 15 g/11 ms		Impacts	18	18
Drop to IEC/EN 60068-2-31	Drop height	mm	50	50
Free fall, packaged (IEC/EN 60068-2-32)		m	1	1
Mounting position			Horizontal/vertical	Horizontal/vertical
Electromagnetic compatibility (EMC)				
Electrostatic discharge (IEC/EN 61000-4-2, severity level 3, ESD)				
Air discharge		kV	8	8
Contact discharge		kV	6	6
Electromagnetic fields (IEC/EN 61000-4-3, RFI)		V/m	10	10
Radio interference suppression (EN 55011)			EN 55011 Class B, EN 55022 Class B	
Burst pulses (IEC/EN 61000-4-4, level 3)				
Supply cables		kV	2	2
Signal lines		kV	2	2
High-energy pulses (surge) (IEC/EN 61000-4-5)		kV	2 (supply cables, symmetrical, EASY...AC)	
High-energy pulses (surge) (IEC/EN 61000-4-5, level 2)		kV	0.5 (supply cables, symmetrical, EASY...DC)	
Immunity to line-conducted interference to (IEC/EN 61000-4-6)		V	10	10
Insulation resistance				
Clearance in air and creepage distances			EN 50178, UL 508, CSA C22.2, No. 142	
Insulation resistance			EN 50178	EN 50178
Back-up/Accuracy of the real-time clock (not easy600)				
Back-up of real-time clock			→ Page 5	→ Page 5
Accuracy of the real-time clock			Normally ± 5 (± 0.5 h/year)	Normally ± 5 (± 0.5 h/year)
Repetition accuracy of the timing relays (not easy600)				
Accuracy of timing relays (of values)		%	± 1	± 0.02
Resolution				
Range "S"		ms	10	5
Range "M:S"		s	1	1
Range "H:M"		min	1	1
Retentive memory				
Write cycles of the retentive memory (at least)			1000000 (10 ⁶)	10000000 (10 ⁷) (read/write cycles)



Moeller HPL0213-2004/2005

			EASY512-AB-...	EASY719-AB-...
Power supply				
Rated operational voltage	U_e	V	24 AC	24 AC
Admissible range		V AC	20.4 – 26.4	20.4 – 26.4
Frequency		Hz	50/60 (\pm 5%)	50/60 (\pm 5%)
Input current				
At 24 V AC 50/60 Hz		mA	Normally 200	Normally 300
Voltage dips (IEC/EN 61131-2)		ms	20	20
Power loss				
At 24 V AC		VA	Normally 5	Normally 7
Digital inputs 24 V DC				
Quantity			8	12
Inputs can be used as analog inputs			2 (I7, I8)	4 (I7, I8, I11, I12)
Status indication			LCD display (if provided)	LCD display (if provided)
Potential isolation				
From power supply			No	No
Between digital inputs			No	No
From the outputs			Yes	Yes
Rated operational voltage	U_e	V	24 AC	24 AC
Rated voltage L (sinusoidal)				
At signal "0"		V AC	0 – 6	0 – 6
At signal "1"	U_e	V	(I7, I8) > 7 AC, > 9.5 DC (I1 - I6) 14 – 26.4 AC	(I7, I8, I11, I12) > 7 AC, > 9.5 DC (I1 - I6, I9, I10) 14 – 26.4 AC
Rated frequency		Hz	50 – 60	50 – 60
Input current at signal "1"				
I1 to I6		mA	4 (at 24 V AC, 50 Hz)	4 (at 24 V AC, 50 Hz)
I7, I8		mA	2 (at 24 V AC, 50 Hz) 2 (at 24 V DC)	2 (at 24 V AC, 50 Hz) 2 (at 24 V DC)
I9, I10		mA	–	4 (at 24 V AC, 50 Hz)
I11, I12		mA	–	2 (at 24 V AC, 50 Hz) 2 (at 24 V DC)
Delay time (0 – 1/1 – 0) I1 - I12				
Debounce ON, 50/60 Hz		ms	80/66 $\frac{2}{3}$	80/66 $\frac{2}{3}$
Debounce OFF, 50/60 Hz		ms	20/16 $\frac{2}{3}$	20/16 $\frac{2}{3}$
Max. admissible cable length (per input)				
Maximum cable length between stripped ends		m	40	40
I9, I10		m	–	Normally 40

NotesFor additional Technical Data EASY5... and EASY7... → AWB2528-1508GB,
EASY8... → AWB2528-1423GB

			EASY512-AC-R..	EASY618-AC-RE
Power supply				
Rated operational voltage	U_e	V	100/110/115/120/230/240 AC (+10/-15 %)	100/110/115/120/230/240 AC (+10/-15 %)
Admissible range		V AC	85 – 264	85 – 264
Frequency		Hz	50/60 (± 5%)	50/60 (± 5%)
Input current				
At 115/120 V AC 60 Hz		mA	Normally 40	Normally 70
At 230/240 V AC 50 Hz		mA	Normally 20	Normally 35
Voltage dips (IEC/EN 61131-2)		ms	20	20
Power loss				
At 115/120 V AC		VA	Normally 5	Normally 10
At 115/230 V AC		VA	Normally 5	Normally 10

			EASY512-AC-R..	EASY618-AC-RE
Digital inputs 115/230 V AC				
Quantity			8	12
Status indication			LCD display (if provided)	LCD display (if provided)
Potential isolation				
From power supply			No	No
Between digital inputs			No	No
From the outputs			Yes	Yes
Rated voltage L (sinusoidal)				
At signal "0"		V AC	0 – 40	0 – 40
At signal "1"		V AC	79 – 264	79 – 264
Rated frequency		Hz	50 – 60	50 – 60
Input current at signal "1"				
R1 to R12		mA	–	12 × 0.25 (at 115 V AC, 60 Hz) 12 × 0.5 (at 230 V AC, 50 Hz)
I1 to I6		mA	6 × 0.25 (at 115 V AC, 60 Hz) 6 × 0.5 (at 230 V AC, 50 Hz)	–
I7, I8		mA	2 × 4 (at 115 V AC, 60 Hz) 2 × 6 (at 230 V AC, 50 Hz)	–
Delay time				
Delay time (0 – 1/1 – 0) I1 - I6, I9 - I12, R1 - R12				
Debounce ON, 50/60 Hz		ms	80/66 $\frac{2}{3}$	80/66 $\frac{2}{3}$
Debounce OFF, 50/60 Hz		ms	20/16 $\frac{2}{3}$	20/16 $\frac{2}{3}$
Delay time I7, I8 (1 – 0)				
Debounce ON, 50/60 Hz		ms	160/150	80/66 $\frac{2}{3}$
Debounce OFF, 50/60 Hz		ms	100/100	20/16 $\frac{2}{3}$
Delay time I7, I8 (0 – 1)				
Debounce ON, 50/60 Hz		ms	80/66 $\frac{2}{3}$	80/66 $\frac{2}{3}$
Debounce OFF, 50/60 Hz		ms	20/16 $\frac{2}{3}$	20/16 $\frac{2}{3}$
Max. admissible cable length (per input)				
R1 to R12		m	–	Normally 40
I1 to I6		m	Normally 40	Normally 40
I7, I8		m	Normally 100	Normally 100
I9 to I12		m	–	Normally 40

Notes

For additional Technical Data EASY5... and EASY7... → AWB2528-1508GB,
EASY8... → AWB2528-1423GB



Moeller HPL0213-2004/2005

			EASY719-AC-...	EASY819-AC-RC.
Power supply				
Rated operational voltage	U_e	V	100/110/115/120/230/240 AC (+10/-15 %)	100/110/115/120/230/240 AC (+10/-15 %)
Admissible range		V AC	85 – 264	85 – 264
Frequency		Hz	50/60 (± 5%)	50/60 (± 5%)
Input current				
At 115/120 V AC 60 Hz		mA	Normally 70	Normally 70
At 230/240 V AC 50 Hz		mA	Normally 35	Normally 35
Voltage dips (IEC/EN 61131-2)		ms	20	20
Power loss				
At 115/120 V AC		VA	Normally 10	Normally 10
At 115/230 V AC		VA	Normally 10	Normally 10
			EASY719-AC-R..	EASY819-AC-R..
Digital inputs 115/230 V AC				
Quantity			12	12
Status indication			LCD display (if provided)	LCD display (if provided)
Potential isolation				
From power supply			No	No
Between digital inputs			No	No
From the outputs			Yes	Yes
From the PC interface, memory card NET network, EASY-Link			–	Yes
Rated voltage L (sinusoidal)				
At signal "0"		V AC	0 – 40	0 – 40
At signal "1"		V AC	79 – 264	79 – 264
Rated frequency		Hz	50 – 60	50 – 60
Input current at signal "1"				
I1 to I6		mA	6 × 0.25 (at 115 V AC, 60 Hz) 6 × 0.5 (at 230 V AC, 50 Hz)	6 × 0.25 (at 115 V AC, 60 Hz) 6 × 0.5 (at 230 V AC, 50 Hz)
I7, I8		mA	2 × 4 (at 115 V AC, 60 Hz) 2 × 6 (at 230 V AC, 50 Hz)	2 × 4 (at 115 V AC, 60 Hz) 2 × 6 (at 230 V AC, 50 Hz)
I9 to I12		mA	4 × 0.25 (at 115 V AC, 60 Hz) 4 × 0.5 (at 230 V AC, 50 Hz)	4 × 0.25 (at 115 V AC, 60 Hz) 4 × 0.5 (at 230 V AC, 50 Hz)
Delay time				
Delay time (0 – 1/1 – 0) I1 - I6, I9 - I12, R1 - R12				
Debounce ON, 50/60 Hz		ms	80/66⅔	80/66⅔
Debounce OFF, 50/60 Hz		ms	20/16⅔	20/16⅔
Delay time I7, I8 (1 – 0)				
Debounce ON, 50/60 Hz		ms	80/66⅔	120/100
Debounce OFF, 50/60 Hz		ms	20/16⅔	40/33⅔
Delay time I7, I8 (0 – 1)				
Debounce ON, 50/60 Hz		ms	80/66⅔	80/66⅔
Debounce OFF, 50/60 Hz		ms	20/16⅔	20/16⅔
Max. admissible cable length (per input)				
I1 to I6		m	Normally 40	Normally 60
I7, I8		m	Normally 100	Normally 100
I9 to I12		m	Normally 40	Normally 60

Notes

For additional Technical Data EASY5... and EASY7... → AWB2528-1508GB, EASY8... → AWB2528-1423GB



			EASY512-DA-...	EASY719-DA-...	EASY512-DC-...
Power supply					
Rated operational voltage	U_e	V	12 DC (-15/+30%)	12 DC (-15/+30%)	24 DC (-15/+20%)
Admissible range		V DC	10.2 – 15.6	10.2 – 15.6	20.4 – 28.8
Residual ripple		%	≤ 5	≤ 5	≤ 5
Input current					
At rated voltage		mA	Normally 140	Normally 200	Normally 80
Voltage dips (IEC/EN 61131-2)		ms	10	10	10
Power loss		W	Normally 2	Normally 3.5	Normally 2

			EASY512-DA-...	EASY719-DA-...
Digital inputs 12 V DC				
Quantity			8	12
Inputs can be used as analog inputs			(2) I7, I8	(4) I7, I8, I11, I12
Status indication			LCD display (if provided)	LCD display (if provided)
Potential isolation				
From power supply			No	No
Between digital inputs			No	No
From the outputs			Yes	Yes
Rated operational voltage	U_e	V DC	12	12
At signal "0"	U_e	V DC	4 (I1 – I8)	4 (I1 – I12)
At signal "1"	U_e	V DC	8 (I1 – I8)	8 (I1 – I12)
Input current at signal "1"				
I1 to I6		mA	3.3 (at 12 V DC)	3.3 (at 12 V DC)
I7, I8		mA	1.1 (at 12 V DC)	1.1 (at 12 V DC)
I9 to I12		mA	–	3.3 (at 12 V DC)
Delay time from 0 to 1				
Debounce ON		ms	20	20
Debounce OFF		ms	Normally 0.3 (I1 – I6), 0.35 (I7, I8)	Normally 0.3 (I1 – I6, I9, I10), 0.35 (I7, I8, I11, I12)
Delay time from 1 to 0				
Debounce ON		ms	20	20
Debounce OFF		ms	Normally 0.3 (I1 – I6), 0.15 (I7, I8)	Normally 0.4 (I1 – I6, I9, I10), 0.35 (I7, I8, I11, I12)
Cable length (unscreened)		m	100	100
Frequency counter			2 (I3, I4)	2 (I3, I4)
High-speed counter inputs			2 (I1, I2)	2 (I1, I2)
Counter frequency			< 1	< 1
Pulse shape			Square	Square
Pulse pause ratio			1:1	1:1
Cable length, screened			< 20	< 20

			EASY512-AB-..., DA, DC	EASY719-AB-..., DA, DC	EASY8...-DC-...
Analog inputs					
Quantity			2 (I7, I8)	4 (I7, I8, I11, I12)	4 (I7, I8, I11, I12)
Potential isolation					
From power supply			No	No	No
From the digital inputs			No	No	No
From the outputs			Yes	Yes	Yes
From the PC interface, memory card NET network, EASY-Link			No	No	Yes
Type of input			DC voltage	DC voltage	DC voltage
Signal range		V DC	0 – 10	0 – 10	0 – 10
Resolution, analog		V	0.01	0.01	0.01
Resolution, digital		V	0.01	0.01	0.01
Resolution, digital		Bit	10 (value 1 – 1023)	10 (value 0 – 1023)	10 (value 0 – 1023)
Input impedance		kΩ	11.2	11.2	11.2
Accuracy of actual value					
Two EASY devices		%	± 3	± 3	± 3
Within a single device		%	± 2, ± 0.12 V	± 2, ± 0.12 V	± 2
Conversion time, analog/digital		ms	Input delay ON: 20; Input delay OFF: each cycle time		Every CPU cycle
Input current		mA	< 1	< 1	< 1
Cable length screened		m	< 30	< 30	< 30

Notes

For additional Technical Data EASY5... and EASY7... → AWB2528-1508GB, EASY8... → AWB2528-1423GB

Moeller HPL0213-2004/2005

			EASY6...-DC-E	EASY7...-DC-...	EASY8...-DC-...
Power supply					
Rated operational voltage	U_e	V	24 DC (-15/+20%)	24 DC (-15/+20%)	24 DC (-15/+20%)
Admissible range		V DC	20.4 – 28.8	20.4 – 28.8	20.4 – 28.8
Residual ripple		%	≤ 5	≤ 5	≤ 5
Input current					
At rated voltage		mA	Normally 140	Normally 140	Normally 140
Voltage dips (IEC/EN 61131-2)		ms	10	10	10
Power loss		W	Normally 3.4	Normally 3.5	Normally 3.4
Digital inputs 24 V DC					
Quantity			8	12	12
Inputs can be used as analog inputs			2 (I7, I8)	–	4 (I7, I8, I11, I12)
Status indication			LCD display (if provided)		
Potential isolation					
From power supply			No	No	No
Between digital inputs			No	No	No
From the outputs			Yes	Yes	Yes
From the PC interface, memory card NET network, EASY-Link			–	–	Yes
Rated operational voltage	U_e	V DC	24	24	24
At signal "0"	U_e	V DC	< 5 (I1 – I8)	< 5 (I1 – I12, R1 – R12)	< 5 (I1 – I12, R1 – R12)
At signal "1"	U_e	V DC	> 15 (I1 – I6), > 8 (I7, I8)	–	> 15.0 (I1 – I6, I9, I10), > 8.0 (I7, I8, I11, I12)
Input current at signal "1"					
R1 to R12		mA	–	3.3 (at 24 V DC)	–
I1 to I6		mA	3.3 (at 24 V DC)	–	3.3 (at 24 V DC)
I7, I8		mA	2.2 (at 24 V DC)	–	2.2 (at 24 V DC)
I9, I10		mA	–	–	3.3 (at 24 V DC)
I11, I12		mA	–	–	2.2 (at 24 V DC)
Delay time from 0 to 1					
Debounce ON		ms	20	20	20
Debounce OFF		ms	Normally 0.25 (I1 – I8)	Normally 0.25 (R1 – R12)	Normally 0.25 (I1 – I12)
Delay time from 1 to 0					
Debounce ON		ms	20	20	20
Debounce OFF		ms	–	–	Normally 0.1 (I1 – I4), Normally 0.4 (I5, I6, I9, I12), Normally 0.2 (I7, I8, I11, I12)
Cable length (unscreened)		m	100	100	100
Frequency counter					
Counter frequency		kHz	< 1	–	< 1
Pulse shape			Square	–	Square
Pulse pause ratio			1:1	–	1:1
Incremental counter					
Counter frequency		kHz	–	–	–
Pulse shape			–	–	Square
Counter inputs I1 and I2, I3 and I4			–	–	2
Signal offset			–	–	90°
Pulse pause ratio			–	–	1:1
High-speed counter inputs					
Counter frequency		kHz	< 1	–	< 1
Pulse shape			Square	–	Square
Pulse pause ratio			1:1	–	1:1
Cable length, screened		m	–	–	< 20

NotesFor additional Technical Data EASY5... and EASY7... → AWB2528-1508GB,
EASY8... → AWB2528-1423GB

			EASY202-RE	EASY512-...-R..
Relay outputs				
Quantity			2	4
Outputs in groups of			2	1
Parallel switching of outputs to increase performance			Not permissible	Not permissible
Protection of an output relay			Miniature circuit-breaker B16 or fuse 8 A (slow)	
Potential isolation				
From power supply			Yes	Yes
From the inputs			Yes	Yes
From the PC interface, memory card, NET network, EASY-Link			No	No
Safe isolation		V AC	300	300
Basic insulation		V AC	600	600
Lifespan, mechanical	Operations	$\times 10^6$	10	10
Contacts				
Conventional thermal current (10 A UL)		A	8	8
Recommended for load: 12 V AC/DC		mA	> 500	> 500
Short-circuit proof $\cos \varphi = 1$, characteristic B16 at 600 A		A	16	16
Short-circuit proof $\cos \varphi = 0.5 - 0.7$; characteristic B16 at 900 A		A	16	16
Rated impulse withstand voltage U_{imp} contact to coil		kV	6	6
Rated operational voltage	U_e	V AC	250	250
Rated insulation voltage	U_i	V AC	250	250
Safe isolation to EN 50178 between coil and contact		V AC	300	300
Safe isolation to EN 50178 between 2 contacts		V AC	300	300
Making capacity				
AC-15, 250 V AC, 3 A (600 ops./h)	Operations		300000	300000
DC-13, $L/R \leq 150$ ms, 24 V DC, 1 A (500 ops./h)	Operations		200000	200000
Breaking capacity				
AC-15, 250 V AC, 3 A (600 ops./h)	Operations		300000	300000
DC-13, $L/R \leq 150$ ms, 24 V DC, 1 A (500 ops./h)	Operations		200000	200000
Filament bulb load				
1000 W at 230/240 V AC	Operations		25000	25000
500 W at 115/120 V AC	Operations		25000	25000
Fluorescent lamp load				
Fluorescent lamp load 10×58 W at 230/240 V AC				
With series-connected electrical device	Operations		25000	25000
Uncompensated	Operations		25000	25000
Fluorescent lamp load 1×58 W at 230/240 V AC conventionally compensated	Operations		25000	25000
Switching frequency				
Mechanical operations		$\times 10^6$	10	10
Switching frequency		Hz	10	10
Resistive load/lamp load		Hz	2	2
Inductive load		Hz	0.5	0.5
UL/CSA				
Uninterrupted current at 240 V AC		A	10	10
Uninterrupted current at 24 V DC		A	8	8
AC				
Control circuit rating codes (utilization category)			B 300 Light Pilot Duty	B 300 Light Pilot Duty
Max. rated operational voltage		V AC	300	300
Max. uninterrupted thermal current $\cos \varphi = 1$ at B 300		A	5	5
Max. make/break capacity $\cos \varphi \neq 1$ at B 300		VA	3600 / 360	3600 / 360
DC				
Control circuit rating codes (utilization category)			R 300 Light Pilot Duty	R 300 Light Pilot Duty
Max. rated operational voltage		V DC	300	300
Max. thermal uninterrupted current at R 300		A	1	1
Max. make/break capacity at R 300		VA	28 / 28	28 / 28

Notes

For additional Technical Data EASY5... and EASY7... → AWB2528-1508GB, EASY8... → AWB2528-1423GB

Moeller HPL0213-2004/2005

			EASY618/719-...-R..	EASY8-...-R...
Relay outputs				
Quantity			6	6
Outputs in groups of			1	1
Parallel switching of outputs to increase performance			Not permissible	Not permissible
Protection of an output relay			Miniature circuit-breaker B16 or fuse 8 A (slow)	Miniature circuit-breaker B16 or fuse 8 A (slow)
Potential isolation				
From power supply			Yes	Yes
From the inputs			Yes	Yes
From the PC interface, memory card, NET network, EASY-Link			No	Yes
Safe isolation		V AC	300	300
Basic insulation		V AC	600	600
Lifespan, mechanical	Operations	$\times 10^6$	10	10
Contacts				
Conventional thermal current (10 A UL)		A	8	8
Recommended for load: 12 V AC/DC		mA	> 500	> 500
Short-circuit proof $\cos \varphi = 1$, characteristic B16 at 600 A		A	16	16
Short-circuit proof $\cos \varphi = 0.5 - 0.7$; characteristic B16 at 900 A		A	16	16
Rated impulse withstand voltage U_{imp} contact to coil		kV	6	6
Rated operational voltage	e	V AC	250	250
Rated insulation voltage	i	V AC	250	250
Safe isolation to EN 50178 between coil and contact		V AC	300	300
Safe isolation to EN 50178 between 2 contacts		V AC	300	300
Making capacity				
AC-15, 250 V AC, 3 A (600 ops./h)	Operations		300000	300000
DC-13, L/R ≤ 150 ms, 24 V DC, 1 A (500 ops./h)	Operations		200000	200000
Breaking capacity				
AC-15, 250 V AC, 3 A (600 ops./h)	Operations		300000	300000
DC-13, L/R ≤ 150 ms, 24 V DC, 1 A (500 ops./h)	Operations		200000	200000
Filament bulb load				
1000 W at 230/240 V AC	Operations		25000	25000
500 W at 115/120 V AC	Operations		25000	25000
Fluorescent lamp load				
Fluorescent lamp load 10×58 W at 230/240 V AC				
With series-connected electrical device	Operations		25000	25000
Uncompensated	Operations		25000	25000
Fluorescent lamp load 1×58 W at 230/240 V AC conventionally compensated	Operations		25000	25000
Switching frequency				
Mechanical operations		$\times 10^6$	10	10
Switching frequency		Hz	10	10
Resistive load/lamp load		Hz	2	2
Inductive load		Hz	0.5	0.5
UL/CSA				
Uninterrupted current at 240 V AC		A	10	10
Uninterrupted current at 24 V DC		A	8	8
AC				
Control circuit rating codes (utilization category)			B 300 Light Pilot Duty	B 300 Light Pilot Duty
Max. rated operational voltage		V AC	300	300
Max. uninterrupted thermal current $\cos \varphi = 1$ at B 300		A	5	5
Max. make/break capacity $\cos \varphi \neq 1$ at B 300		VA	3600/360	3600/360
DC				
Control circuit rating codes (utilization category)			R 300 Light Pilot Duty	R 300 Light Pilot Duty
Max. rated operational voltage		V DC	300	300
Max. thermal uninterrupted current at R 300		A	1	1
Max. make/break capacity at R 300		VA	28/28	28/28

Notes

For additional Technical Data EASY5... and EASY7... → AWB2528-1508GB, EASY8... → AWB2528-1423GB



			EASY512-DC-T..	EASY620-DC-TE
Transistor outputs				
Quantity			4	8
Rated operational voltage [transistor outputs]	U_e	V DC	24	24
Admissible range	U_e	V DC	20.4 – 28.8	20.4 – 28.8
Residual ripple		%	≤ 5	≤ 5
Supply current				
At signal "0"	Normal-ly/max.	mA	9/16	18/32
At signal "1"	Normal-ly/max.	mA	12/22	24 – 44
Protection against polarity reversal			Yes (Caution: A short circuit will result if voltage is applied to the outputs in the event that the supply voltage is connected to the wrong poles.)	
Potential isolation				
From power supply			Yes	Yes
From the inputs			Yes	Yes
From the PC interface, memory card, NET network, EASY-Link			–	–
Rated operational current at signal "1" DC	I_e	A	max. 0.5	max. 0.5
Lamp load without R_v		W	5	5
Residual current at signal "0" per channel		mA	< 0.1	< 0.1
Max. output voltage				
With condition "0" at external load < 10 MΩ		V	2.5	2.5
With condition "1" at $I_e = 0.5$ A		V	$U = U_e - 1$ V	$U = U_e - 1$ V
Short-circuit protection			Yes, thermal (analysis via diagnostics input I16, I15; R15, R16)	
Short-circuit tripping current for $R_a \leq 10$ mΩ		A	$0.7 \leq I_e \leq 2$ per output	$0.7 \leq I_e \leq 2$
Total short-circuit current		A	8	16
Peak short-circuit current		A	16	32
Thermal cutout			Yes	Yes
Max. operating frequency at constant resistive load $R_L < 100$ kΩ (dependent on program and load)		Ops/h	40000	40000
Parallel connection of outputs				
With resistive load, inductive load with external suppressor circuit, combination within a group			Group 1: Q1 to Q4	Group 1: S1 - S4 Group 2: S5 - S8
Number of outputs	max.		4	4
Total max. current		A	2 (Caution! Outputs must be actuated simultaneously and for the same length of time.)	
Status indication of outputs			LCD display (if provided)	LCD display (if provided)
Inductive load¹⁾				
Without external suppressor circuit				
$T_{0.95} = 1$ ms, $R = 48$ Ω, $L = 16$ mH				
Utilization factor		g	0.25	0.25
Duty factor		% DF	100	100
Max. operating frequency $f = 0.5$ Hz (max. DF = 50 %)		Operations	1500	1500
DC-13, $T_{0.95} = 72$ ms, $R = 48$ Ω, $L = 1.15$ H				
Utilization factor		g	0.25	0.25
Duty factor		% DF	100	100
Max. operating frequency $f = 0.5$ Hz (max. DF = 50 %)		Operations	1500	1500
$T_{0.95} = 15$ ms, $R = 48$ Ω, $L = 0.24$ H				
Utilization factor		g	0.25	0.25
Duty factor		% DF	100	100
Max. operating frequency $f = 0.5$ Hz (max. DF = 50 %)		Operations	1500	1500
With external suppressor circuit				
Utilization factor		g	1	1
Duty factor		% DF	100	100
Max. switching frequency, max. duty factor		Operations	Depending on the suppressor circuit	

Notes

¹⁾ $T_{0.95}$ = Time in ms, until 95 % of the steady-state current has been reached. $T_{0.95} \approx 3 \times T_{0.65} = 3 \times L/R$. Bus lengths greater than 40 m can only be achieved with enhanced cross-section conductors and terminal adapters.



Moeller HPL0213-2004/2005

			EASY721-DC-TC.	EASY8..-DC-TC.
Transistor outputs				
Quantity			8	8
Rated operational voltage	U_e	V DC	24	24
Admissible range	U_e	V DC	20.4 – 28.8	20.4 – 28.8
Residual ripple		%	≤ 5	≤ 5
Supply current				
At signal "0"	Normal-ly/max.	mA	18/32	18/32
At signal "1"	Normal-ly/max.	mA	24 – 44	24 – 44
Protection against polarity reversal			Yes (Caution: A short circuit will result if voltage is applied to the outputs in the event that the supply voltage is connected to the wrong poles.)	
Potential isolation				
From power supply			Yes	Yes
From the inputs			Yes	Yes
From the PC interface, memory card NET network, EASY-Link			–	Yes
Rated operational current at signal "1" DC	I_e	A	max. 0.5	max. 0.5
Lamp load without R_v		W	5	3 (Q1 – Q4) 5 (Q5 – Q8)
Residual current at signal "0" per channel		mA	< 0.1	< 0.1
Max. output voltage				
With condition "0" at external load < 10 MΩ		V	2.5	2.5
With condition "1" at $I_e = 0.5$ A		V	$U = U_e - 1$ V	$U = U_e - 1$ V
Short-circuit protection			Yes, thermal (analysis via diagnostics input I16, I15; R15, R16)	Yes, electronic (Q1 – Q4), thermal (Q5 – Q8), (analysis via diagnostics input I16, I15)
Short-circuit tripping current for $R_a \leq 10$ mΩ		A	$0.7 \leq I_e \leq 2$ per output	$0.7 \leq I_e \leq 2$ per output
Total short-circuit current		A	16	16
Peak short-circuit current		A	32	32
Thermal cutout			Yes	Yes
Max. operating frequency at constant resistive load $R_L < 100$ kΩ (dependent on program and load)		Ops/h	40000	40000
Parallel connection of outputs				
With resistive load, inductive load with external suppressor circuit, combination within a group			Group 1: Q1 to Q4 Group 2: Q5 - Q8	Group 1: Q1 to Q4 Group 2: Q5 - Q8
Number of outputs	max.		4	4
Total max. current		A	2 (Caution! Outputs must be actuated simultaneously and for the same length of time.)	
Status indication of outputs			LCD display (if provided)	LCD display (if provided)
Inductive load ¹⁾				
Without external suppressor circuit				
$T_{0.95} = 1$ ms, $R = 48$ Ω, $L = 16$ mH				
Utilization factor		g	0.25	0.25
Duty factor		% DF	100	100
Max. operating frequency $f = 0.5$ Hz (max. DF = 50 %)		Operations	1500	1500
DC-13, $T_{0.95} = 72$ ms, $R = 48$ Ω, $L = 1.15$ H				
Utilization factor		g	0.25	0.25
Duty factor		% DF	100	100
Max. operating frequency $f = 0.5$ Hz (max. DF = 50 %)		Operations	1500	1500
$T_{0.95} = 15$ ms, $R = 48$ Ω, $L = 0.24$ H				
Utilization factor		g	0.25	0.25
Duty factor		% DF	100	100
Max. operating frequency $f = 0.5$ Hz (max. DF = 50 %)		Operations	1500	1500
With external suppressor circuit				
Utilization factor		g	1	1
Duty factor		% DF	100	100
Max. switching frequency, max. duty factor		Operations	Depending on the suppressor circuit	

Notes

¹⁾ $T_{0.95}$ = Time in ms, until 95 % of the steady-state current has been reached. $T_{0.95} \approx 3 \times T_{0.65} = 3 \times L/R$.
 Bus lengths greater than 40 m can only be achieved with enhanced cross-section conductors and terminal adapters.
 For additional Technical Data EASY5... and EASY7... → AWB2528-1508GB, EASY8... → AWB2528-1423GB



		EASY820-DC-RC(X) EASY822-DC-TC(X)
Analog outputs		
Quantity		1
Potential isolation		
From power supply		No
From the digital inputs		No
From the digital outputs		Yes
From the PC interface, memory card NET network, EASY-Link		Yes
Type of output		DC voltage
Signal range	V DC	0 – 10
Max. output current	A	0.01
Load resistance		1 kΩ
Overload and short-circuit protection		Yes
Resolution, analog	V DC	0.01
Resolution, digital	Bit	10, (value: 0 – 1023)
Recovery time	μs	100
Accuracy		
–25 °C to 55 °C	%	2
25 °C	%	1
Conversion time, analog/digital	ms	Every CPU cycle

Notes

For additional Technical Data EASY5... and EASY7... → AWB2528-1508GB,
EASY8... → AWB2528-1423GB

EASY8...-...-...

		EASY8...-...-...
NET network		
Stations	Quantity	max. 8
Data transfer rate/distance		1000 KBit/s, 6 m 500 KBit/s, 25 m 250 KBit/s, 60 m 125 KBit/s, 125 m 50 KBit/s, 300 m 20 KBit/s, 700 m 10 KBit/s, 1000 m
Potential isolation		
From power supply		Yes
From the inputs		Yes
From the outputs		Yes
From the PC interface, memory card NET network, EASY-Link		Yes
Bus termination (first and last station)		Yes
Terminations		RJ45, 8-pole

Notes

For additional Technical Data EASY5... and EASY7... → AWB2528-1508GB,
EASY8... → AWB2528-1423GB

The following applies to data transfer rate/distance in the NET network:
Bus lengths greater than 40 m can only be achieved with enhanced
cross-section conductors and terminal adapters.



Moeller HPL0213-2004/2005

				EASY205-ASI	EASY204-DP
General technical data					
Standards			EN 55011, EN 55022, IEC/EN 61000-4, IEC/EN 60068-2-27, EN 50295		
Dimensions (W × H × D)		mm	35.5 × 90 × 58 (2 space units)	35.5 × 90 × 58 (2 space units)	
Weight		kg	0.12	0.15	
Mounting			Top-hat rail IEC/EN 60715, 35 mm or screw fixing using fixing brackets ZB4-101-GF1 (accessories)		
Terminal capacity					
Solid		mm ²	0.2/4 (AWG 22 – 12)	0.2/4 (AWG 22 – 12)	
Flexible with ferrule		mm ²	0.2/2.5 (AWG 22 – 12)	0.2/2.5 (AWG 22 – 12)	
Standard screwdriver		mm	3.5 × 0.8	3.5 × 0.8	
Max. tightening torque		Nm	0.6	0.6	
Ambient climatic conditions					
Operational ambient temperature		°C	–25/+55, low temperatures to IEC 60068-2-1, high temperatures to IEC 60068-2-2		
Condensation			Prevent condensation by means of suitable measures		
Storage		°C	40 – 70	40 – 70	
Relative humidity, non-condensing (IEC/EN 60068-2-30)		%	5 – 95	5 – 95	
Atmospheric pressure (operation)		hPa	795 – 1080	795 – 1080	
Corrosion resistance					
IEC/EN 60947-2-42	4 days SO ₂	cm ³ /m ³	10	10	
IEC/EN 60068-2-43	4 days H ₂ S	cm ³ /m ³	1	1	
Ambient mechanical conditions					
Pollution degree			2	2	
Degree of protection (IEC/EN 60529)			IP20	IP20	
Vibrations (IEC/EN 60068-2-6)					
Constant amplitude 0.15 mm		Hz	10 – 57	10 – 57	
Constant acceleration, 2 g		Hz	57 – 150	57 – 150	
Mechanical shock resistance (IEC/EN 60068-2-27) semi-sinusoidal 15 g/11 ms				Impacts	
			18	18	
Drop to IEC/EN 60068-2-31	Drop height	mm	50	50	
Free fall, packaged (IEC/EN 60068-2-32)		m	1	1	
Mounting position			Horizontal/vertical	Horizontal/vertical	
Electromagnetic compatibility (EMC)					
Electrostatic discharge (IEC/EN 61000-4-2, Level 3, ESD)					
Air discharge		kV	8	8	
Contact discharge		kV	6	6	
Electromagnetic fields (IEC/EN 61000-4-3, RFI)				V/m	
			10	10	
Radio interference suppression (EN 55011)				EN 55011 Class B, EN 55022 Class B	
			EN 55011 Class A, EN 55022 Class A		
Burst pulses (IEC/EN 61000-4-4, level 3)					
AS-Interface cables		kV	2	–	
Supply cables		kV	–	2	
Signal lines		kV	–	2	
High-energy pulses (surge) (IEC/EN 61000-4-5, level 2)				kV	
			–	0.5 (supply cables, symmetrical)	
Immunity to line-conducted interference (IEC/EN 61000-4-6)				V	
			10	10	
Insulation resistance					
Clearance in air and creepage distances				EN 50178, UL 508, CSA C22.2, No. 142	
Insulation resistance				EN 50178	EN 50178
Power supply					
Rated operational voltage	U _e	V	26.5 – 31.6	24 (-15/+20 %)	
Admissible range		V DC	–	20.4 – 28.8	
Total power consumption of the AS-Interface		mA	≤ 30	–	
Residual ripple		%	–	< 5	
At 24 V DC		mA	–	Normally 200	
Voltage dips (IEC/EN 61131-2)		ms	–	10	
Heat dissipation at 24 V DC		W	–	4.8	
Protection against polarity reversal					
AS-Interface protection against polarity reversal				Yes	–
AS-Interface profile				7F (hex)	–
Slave addresses				0 – 31	–
Addressing unit interface				3.5 mm socket	–
Power supply				–	Yes



	EASY205-ASI	EASY204-DP
LED displays		
Power supply	Power: green	Power LED (POW): green
LED display	Com Error: red	LED-PROFIBUS-DP (BUS): red
Logic links		
easy700/easy800 contact and coil ↔ AS-Interface	S1 → input 0 S2 → input 1 S3 → input 2 S4 → input 3 R1 ← output 0 R2 ← output 1 R3 ← output 2 R4 ← output 3 R5 ← PARAMETEROUTPUT 0 R6 ← PARAMETEROUTPUT 1 R7 ← PARAMETEROUTPUT 2 R8 ← PARAMETEROUTPUT 3	–
PROFIBUS DP		
Terminations	–	SUB-D 9-pole, socket
Potential isolation	–	Between bus and power supply (simple), between bus and power supply and easy base unit (safe isolation)
Function	–	PROFIBUS DP slave
Interface	–	RS 485
Bus protocol	–	PROFIBUS DP
Baud rates	–	Automatic search up to 12 MBit/s
Bus terminating resistors	–	Can be connected via plug
Bus addresses	–	1 – 126, can be addressed via easy base unit with display or via EASY-SOFT
Services		
Cyclical	–	All data R1 – R16, S1 – S8
Acyclical	–	Read/write, real-time, day, summer-/winter time, all the parameters of the EASY function relay



Moeller HPL0213-2004/2005

				EASY221-CO	EASY222-DN
General technical data					
Standards				EN 55011, EN 55022, EN 61000-4, IEC 60068-2-6, IEC 60068-2-27	
Dimensions (W × H × D)		mm		35.5 × 90 × 58 (2 space units)	35.5 × 90 × 58 (2 space units)
Weight		kg		0.15	0.15
Mounting				Top-hat rail IEC/EN 60715, 35 mm or screw fixing using fixing brackets ZB4-101-GF1 (accessories)	
Terminal capacity					
Solid		mm ²		0.2/4 (AWG 22 – 12)	0.2/4 (AWG 22 – 12)
Flexible with ferrule		mm ²		0.2/2.5 (AWG 22 – 12)	0.2/2.5 (AWG 22 – 12)
Standard screwdriver		mm		3.5 × 0.8	3.5 × 0.8
Max. tightening torque		Nm		0.6	0.6
Ambient climatic conditions					
Operational ambient temperature		°C		–25/+55, low temperatures to IEC 60068-2-1, high temperatures to IEC 60068-2-2	
Condensation				Prevent condensation by means of suitable measures	
Storage		°C		40 – 70	40 – 70
Relative humidity, non-condensing (IEC/EN 60068-2-30)		%		5 – 95	5 – 95
Atmospheric pressure (operation)		hPa		795 – 1080	795 – 1080
Corrosion resistance					
IEC/EN 60947-2-42	4 days SO ₂	cm ³ /m ³		10	10
IEC/EN 60068-2-43	4 days H ₂ S	cm ³ /m ³		1	1
Ambient mechanical conditions					
Pollution degree				2	2
Degree of protection (IEC/EN 60529)				IP20	IP20
Vibrations (IEC/EN 60068-2-6)					
Constant amplitude 0.15 mm		Hz		10 – 57	10 – 57
Constant acceleration, 2 g		Hz		57 – 150	57 – 150
Mechanical shock resistance (IEC/EN 60068-2-27)					
semi-sinusoidal 15 g/11 ms		Impacts		18	18
Drop to IEC/EN 60068-2-31	Drop height	mm		50	50
Free fall, packaged (IEC/EN 60068-2-32)		m		1	1
Mounting position				Horizontal/vertical	Horizontal/vertical
Electromagnetic compatibility (EMC)					
Electrostatic discharge (IEC/EN 61000-4-2, Level 3, ESD)					
Air discharge		kV		8	8
Contact discharge		kV		6	6
Electromagnetic fields (IEC/EN 61000-4-3, RF1)		V/m		10	10
Radio interference suppression (EN 55011)					
Burst pulses (IEC/EN 61000-4-4, level 3)				EN 55011 Class B, EN 55022 Class B	
AS-Interface cables		kV		–	–
Supply cables		kV		2	2
Signal lines		kV		2	2
High-energy pulses (surge) (IEC/EN 61000-4-5, level 2)		kV		0.5 (supply cables, symmetrical)	
Immunity to line-conducted interference (IEC/EN 61000-4-6)		V		10	10



			EASY221-CO	EASY222-DN
Insulation resistance				
Clearance in air and creepage distances			EN 50178, UL 508, CSA C22.2, No. 142	
Insulation resistance			EN 50178	EN 50178
Power supply				
Rated operational voltage	U_e	V	24 (-15/+20 %)	24 (-15/+20 %)
Admissible range		V DC	20.4 – 28.8	20.4 – 28.8
Residual ripple		%	< 5	< 5
At 24 V DC		mA	Normally 200	Normally 200
Voltage dips (IEC/EN 61131-2)		ms	10	10
Heat dissipation at 24 V DC		W	4.8	4.8
Protection against polarity reversal				
Power supply			Yes	Yes
LED displays				
Power supply			RUN LED (RUN): green	Module status LED (MS): green
LED display			LED ERROR (ERR): red	Network status LED (NS): red/green
Network				
Terminations			RJ45	5-pole, pluggable screw terminal
Potential isolation			Between bus and power supply (simple), between bus and power supply and easy base unit (safe isolation)	Between bus and power supply (simple), between bus and power supply and easy base unit (safe isolation)
Function			CANopen slave	DeviceNet slave
Interface			CAN	CAN
Bus protocol			CANopen	DeviceNet
Baud rates			Automatic search up to 1 MBit/s	Automatic search up to 500 kBit/s
Bus terminating resistors			Separate external bus termination required (120 Ω)	Separate external bus termination required (120 Ω)
Bus addresses			1 – 127, can be addressed via easy base unit with display or via EASY-SOFT	0 – 63, can be addressed via easy base unit with display or via EASY-SOFT
Services				
Cyclical			All data R1 – R16, S1 – S8	All data R1 – R16, S1 – S8
Acyclical			Read/write, real-time, day, summer-/winter time, all the parameters of the EASY function relay	Read/write, real-time, day, summer-/winter time, all the parameters of the EASY function relay



Moeller HPL0213-2004/2005

			EASY200-POW	EASY400-POW
General technical data				
Standards			EN 55011, EN 55022, IEC/EN 61000-4..., IEC/EN 60068-2-27	
Dimensions (W × H × D)		mm	35.5 × 90 × 58 (2 space units)	71.5 × 90 × 58 (4 space units)
Weight		kg	0.1	0.25
Mounting			Top-hat rail IEC/EN 60715, 35 mm or screw fixing using fixing brackets ZB4-101-GF1 (accessories)	
Terminal capacity				
Solid		mm ²	0.2/4 (AWG 22 – 12)	0.2/4 (AWG 22 – 12)
Flexible with ferrule		mm ²	0.2/2.5 (AWG 22 – 12)	0.2/2.5 (AWG 22 – 12)
Standard screwdriver		mm	3.5 × 0.8	3.5 × 0.8
Max. tightening torque		Nm	0.6	0.6
Ambient climatic conditions				
Operational ambient temperature		°C	–25/+55, low temperatures to IEC 60068-2-1, high temperatures to IEC 60068-2-2	
Condensation			Prevent condensation by means of suitable measures	
Storage		°C	40 – 70	40 – 70
Relative humidity, non-condensing (IEC/EN 60068-2-30)		%	5 – 95	5 – 95
Atmospheric pressure (operation)		hPa	795 – 1080	795 – 1080
Corrosion resistance				
IEC/EN 60947-2-42	4 days SO ₂	cm ³ /m ³	10	10
IEC/EN 60068-2-43	4 days H ₂ S	cm ³ /m ³	1	1
Max. installation altitude above sea level, observe derating at higher altitudes		m	2000	2000
Ambient mechanical conditions				
Pollution degree			2	2
Degree of protection (IEC/EN 60529)			IP20	IP20
Vibrations (IEC/EN 60068-2-6)				
Constant amplitude 0.15 mm		Hz	10 – 57	10 – 57
Constant acceleration, 2 g		Hz	57 – 150	57 – 150
Mechanical shock resistance (IEC/EN 60068-2-27) semi-sinusoidal 15 g/11 ms		Impacts	18	18
Drop to IEC/EN 60068-2-31	Drop height	mm	50	50
Free fall, packaged (IEC/EN 60068-2-32)		m	1	1
Mounting position			Horizontal/vertical	Horizontal/vertical
Electromagnetic compatibility (EMC)				
Electrostatic discharge (IEC/EN 61000-4-2, Level 3, ESD)				
Air discharge		kV	8	8
Contact discharge		kV	6	6
Electromagnetic fields (IEC/EN 61000-4-3, RFI)		V/m	10	10
Radio interference suppression (EN 55011)			EN 50011 Class B; EN 60715 Class B, EN 50081-2 Class B	
Burst pulses (IEC/EN 61000-4-4, level 3)		kV	2	2
High-energy pulses (surge) (IEC/EN 61000-4-5)		kV	2 (supply cables, symmetrical, EASY...AC)	
High-energy pulses (surge) (IEC/EN 61000-4-5, level 2), 24 V		kV	0,5 (output cables, symmetrical)	
Immunity to line-conducted interference (IEC/EN 61000-4-6)		V	10	10
Surge voltage (EN 50178), 24 V		kV	6	6
Insulation resistance				
Clearance in air and creepage distances			EN 50178	EN 50178
Insulation resistance			EN 50178	EN 50178
Protection class U _{out} against U _{in}			Class II to IEC 60536	Class II to IEC 60536
Potential isolation primary/secondary			Yes, SELV (VDE 0100 Part 410; IEC 60364-4-41, HD 384.4.41 S2) EN 60950	
Input voltage				
Rated input voltage AC		V	100/120/230/240 (–15/+10 %)	100/120/230/240 (–15/+10 %)
Protective switches AC			FAZ-C1/1 or FAZ-B6/1	FAZ-C2/1 or FAZ-B6/1
Rated input voltage DC		V	85 – 265	85 – 265
DC protective switches			FAZ-C2/1-DC	FAZ-C2/1-DC
Voltage range		V AC	85 – 264	85 – 264
Frequency range		Hz	47 – 63	47 – 63
Power failure bridging 115/230 V		ms	> 10/> 20	> 10/> 20
Fuse 115/230 V		A	1.5 slow	2/1 slow



		EASY200-POW	EASY400-POW
Rating data			
Efficiency	%	> 81	> 87
Power consumption	W	Normally 7	Normally 35
Power loss	W	Normally 1	Normally 5
Input current			
Rated input current value 115/230 V AC	A	Approx. 0.17/0.05	Approx. 0.3/0.15
Inrush current at 25 °C 230 V	A	< 5	< 5
Output voltage			
12 V DC (reference voltage)			
Rated value	V DC	12	–
Tolerance	%	± 4	–
Switching peaks	mV _{SS}	< 7	–
Effect of input voltage	%	± 1	–
Effect with 25 – 100 % load change	%	± 1	–
24 V DC			
Rated value	V DC	24	24
Tolerance	%	± 3	± 5
Switching peaks 115/230	mV _{SS}	< 50/30	< 5
Effect of input voltage	%	± 1	± 1
Effect with 25 – 100 % load change	%	± 1	± 2
Output current			
12 V DC (reference voltage)			
Output current	mA	0 – 20	–
Effectiveness of current limitation	mA	20	–
Reduction of output voltage after current limitation	V	< 12	–
Overload proof		Yes, by current limitation permanently short-circuit proof	–
Proof against sustained short circuit		Yes	–
24 V DC			
Output current	A	0 – 0.25	0 – 1.25
Effectiveness of current limitation	A	> 0.3	> 1.25
Reduction of output voltage after current limitation	V	–	< 18
Overload proof		Yes, by current limitation	Yes, by current limitation
Proof against sustained short circuit		Yes, hiccup-mode	Yes, hiccup mode, approx. 10 Hz
Special load conditions			
Lamp load, cold, 24 V DC	W	2	10
Base load present	W	2	5
Behaviour in the event of Emergency-Stop in 24 V circuit, switch Off using contactor (contactor load, no damage)	W	6	30
Displays			
Indication of output voltage (LED, continuous green light = OK)	V DC	24	24



Moeller HPL0213-2004/2005

				EASY256-HCI
General technical data				
Standards				EN 55011, EN 55022, IEC/EN 61000-4, IEC 60068-2-6, IEC 60068-2-27
Dimensions (W × H × D)		mm		35,5 × 90 × 58 (2 space units)
Mounting				Top-hat rail IEC/EN 60715, 35 mm or screw fixing using fixing brackets ZB4-101-GF1 (accessories)
Channels		Quantity		6
Voltage range at U_e				0 – 264
Current increase 115/230 V AC		mA		4/6
Extension of the Off-delay of each EASY input ("1" after "0") 50/60 Hz		ms		40/37
Cable length		m		100
Parallel switching of outputs to increase performance				Several possible (Off-delay extended depending on the number of parallel channels)
Kind of resistor				Capacitive
Terminal capacity				
Solid		mm ²		0.2/4 (AWG 22 – 12)
Flexible with ferrule		mm ²		0.2/2.5 (AWG 22 – 12)
Standard screwdriver		mm		3.5 × 0.8
Max. tightening torque		Nm		0.6
Ambient climatic conditions				
Operational ambient temperature		°C		-25 to 55, low temperatures to IEC 60068-2-1, high temperatures to IEC 60068-2-2
Condensation				Prevent condensation by means of suitable measures
Storage		°C		40 – 70
Relative humidity, non-condensing (IEC/EN 60068-2-30)		%		5 – 95
Atmospheric pressure (operation)		hPa		795 – 1080
Corrosion resistance				
IEC/EN 60947-2-42	4 days SO ₂	cm ³ /m ³		10
IEC/EN 60068-2-43	4 days H ₂ S	cm ³ /m ³		1
Ambient mechanical conditions				
Pollution degree				2
Degree of protection (IEC/EN 60529)				IP20
Vibrations (IEC/EN 60068-2-6)				
Constant amplitude 0.15 mm		Hz		10 – 57
Constant acceleration, 2 g		Hz		57 – 150
Mechanical shock resistance (IEC/EN 60068-2-27) semi-sinusoidal 15 g/11 ms		Impacts		18
Drop to IEC/EN 60068-2-31	Drop height	mm		50
Free fall, packaged (IEC/EN 60068-2-32)		m		1
Mounting position				Horizontal/vertical
Electromagnetic compatibility (EMC)				
Electrostatic discharge (IEC/EN 61000-4-2, Level 3, ESD)				
Air discharge		kV		8
Contact discharge		kV		6
Electromagnetic fields (IEC/EN 61000-4-3, RFI)		V/m		10
Radio interference suppression (EN 55011)				EN 55011 Class B, EN 55022 Class B
High-energy pulses (surge) (IEC/EN 61000-4-5)		kV		2 (supply cables, symmetrical, EASY...AC)
Immunity to line-conducted interference (IEC/EN 61000-4-6)		V		10
Insulation resistance				
Clearance in air and creepage distances				EN 50178, UL 508, CSA C22.2, No. 142
Insulation resistance				EN 50178



MFD Multi-Function Displays

Moeller HPL0213-2004/2005

			MFD-80..	MFD-CP8.., MFD-AC-CP8..
General technical data				
Standards			EN 61000-6-1/-2/-3/-4, IEC 60068-2-6, IEC 60068-2-27	
Dimensions (W × H × D)		mm	86.5 × 86.5 × 21.5 (with actuators) 86.5 × 86.5 × 20 (without actuators)	107.5 × 90 × 30
Weight		kg	0.13	0.145
Mounting			2 × 22.5 mm, display fastened using 2 threaded fixing rings	Fitted on the fixing shaft of the display or on top-hat rail to IEC/EN 60715, 35 mm (without display) or by means of brackets (without display)
Terminal capacity				
Solid		mm ²	–	0.2/4 (AWG 24 – 12)
Flexible with ferrule		mm ²	–	0.2/2.5 (AWG 24 – 12)
Standard screwdriver		mm	–	3.5 × 0.6
Ambient climatic conditions				
Operational ambient temperature		°C	–25/+55, low temperatures to IEC 60068-2-1, high temperatures to IEC 60068-2-2	
Condensation			Prevent condensation by means of suitable measures	
LCD display (clearly legible)		°C	–5 to 50, (–10 to 0 with back-lighting switched On (continuous duty))	–
Storage		°C	40 – 70	40 – 70
Relative humidity, non-condensing (IEC/EN 60068-2-30)		%	5 – 95	5 – 95
Atmospheric pressure (operation)		hPa	795 – 1080	795 – 1080
Ambient mechanical conditions				
Pollution degree			3	2
Degree of protection (IEC/EN 60529)			IP65	IP20
Vibrations (IEC/EN 60068-2-6)				
Constant amplitude 0.15 mm		Hz	10 – 57	10 – 57
Constant acceleration, 2 g		Hz	57 – 150	57 – 150
Mechanical shock resistance (IEC/EN 60068-2-27) semi-sinusoidal 15 g/11 ms		Impacts	18	18
Drop to IEC/EN 60068-2-31	Drop height	mm	50	50
Free fall, packaged (IEC/EN 60068-2-32)		m	1	1
Mounting position			Horizontal/vertical	Horizontal/vertical
Electromagnetic compatibility (EMC)				
Electrostatic discharge (IEC/EN 61000-4-2, Level 3, ESD)				
Air discharge		kV	8	8
Contact discharge		kV	6	6
Electromagnetic fields (IEC/EN 61000-4-3, RFI)		V/m	10	10
Radio interference suppression (EN 55011)			EN 55011 Class B, EN55022 Class B	
Burst pulses (IEC/EN 61000-4-4, level 3)				
Supply cables		kV	2	2
Signal lines		kV	2	2
High-energy pulses (surge) (IEC/EN 61000-4-5)		kV	2 (supply cables, symmetrical, MFD-AC-CP8..)	
High-energy pulses (surge) (IEC/EN 61000-4-5, level 2)		kV	0.5 (supply cables, symmetrical, MFD-CP8..)	
Immunity to line-conducted interference (IEC/EN 61000-4-6)		V	10	10
Insulation resistance				
Clearance in air and creepage distances			EN 50178, UL 508, CSA C22.2, No. 142	
Insulation resistance			EN 50178	EN 50178
Back-up/Accuracy of the real-time clock				
Back-up of real-time clock			–	→ Page 5
Accuracy of the real-time clock			–	Normally ±5 s/day (±0.5 h/year)
Repetition accuracy of timing relays				
Accuracy of timing relays (of values)		%	–	± 0.02
Resolution				
Range "S"		ms	–	5
Range "M:S"		s	–	1
Range "H:M"		min	–	1
Retentive memory				
Write cycles of the retentive memory (at least)			–	≥ 10 ¹⁰ (Read/write cycles)



Moeller HPL0213-2004/2005

			MFD-CP4...
General technical data			
Standards			EN 61000-6-1/-2/-3/-4, IEC 60068-2-6, IEC 60068-2-27
Dimensions (W × H × D)		mm	75 × 58 × 36.2
Weight		kg	0,164
Mounting			Plug-fitted to the display fixing shaft
Terminal capacity			
Power supply			
Solid		mm ²	0.2/4 (AWG 24 – 12)
Flexible with ferrule		mm ²	0.2/2.5 (AWG 24 – 12)
Standard screwdriver		mm	3.5 × 0.6
Data cable			
Solid		mm ²	0.08/2.5 (AWG 28 – 12)
Flexible with ferrule		mm ²	0.08/1.5 (AWG 28 – 12)
Standard screwdriver		mm	–
Ambient climatic conditions			
Operational ambient temperature		°C	-25 to 55, low temperatures to IEC 60068-2-1, high temperatures to IEC 60068-2-2
Condensation			Prevent condensation by means of suitable measures
Storage		°C	40 – 70
Relative humidity, non-condensing (IEC/EN 60068-2-30)		%	5 – 95
Atmospheric pressure (operation)		hPa	795 – 1080
Ambient mechanical conditions			
Pollution degree			2
Degree of protection (IEC/EN 60529)			IP20
Vibrations (IEC/EN 60068-2-6)			
Constant amplitude 0.15 mm		Hz	10 – 57
Constant acceleration, 2 g		Hz	57 – 150
Mechanical shock resistance (IEC/EN 60068-2-27) semi-sinusoidal 15 g/11 ms		Impacts	18
Drop to IEC/EN 60068-2-31	Drop height	mm	50
Free fall, packaged (IEC/EN 60068-2-32)		m	1
Mounting position			Horizontal/vertical
Electromagnetic compatibility (EMC)			
Electrostatic discharge (IEC/EN 61000-4-2, Level 3, ESD)			
Air discharge		kV	8
Contact discharge		kV	6
Electromagnetic fields (IEC/EN 61000-4-3, RFI)		V/m	10
Radio interference suppression (EN 55011)			EN 55011 Class B, EN55022 Class B
Burst pulses (IEC/EN 61000-4-4, level 3)			
Supply cables		kV	2
Signal lines		kV	2
High-energy pulses (surge) (IEC/EN 61000-4-5, level 2)		kV	1 (supply cables, symmetrical)
Immunity to line-conducted interference (IEC/EN 61000-4-6)		V	10
Insulation resistance			
Clearance in air and creepage distances			EN 50178, UL 508, CSA C22.2, No. 142
Insulation resistance			EN 50178



MFD Multi-Function Displays

Moeller HPL0213-2004/2005

			MFD-R.., MFD-AC-R..	MFD-T...
General technical data				
Standards			EN 61000-6-1/-2/-3/-4, IEC/EN 61000-4, IEC 60068-2-6, IEC 60068-2-27	
Dimensions (W × H × D)		mm	89 × 90 × 44	89 × 90 × 25 (built-in)
Weight		kg	0.15	0.14
Mounting			Fitted into the power supply unit.	Fitted into the power supply unit.
Terminal capacity				
Solid		mm ²	0.2/4 (AWG 24 – 12)	0.2/4 (AWG 24 – 12)
Flexible with ferrule		mm ²	0.2/2.5 (AWG 24 – 12)	0.2/2.5 (AWG 24 – 12)
Standard screwdriver		mm	3.5 × 0.6	3.5 × 0.6
Ambient climatic conditions				
Operational ambient temperature		°C	–25/+55, low temperatures to IEC 60068-2-1, high temperatures to IEC 60068-2-2	
Condensation			Prevent condensation by means of suitable measures	
Storage		°C	40 – 70	40 – 70
Relative humidity, non-condensing (IEC/EN 60068-2-30)		%	5 – 95	5 – 95
Atmospheric pressure (operation)		hPa	795 – 1080	795 – 1080
Ambient mechanical conditions				
Pollution degree			2	2
Degree of protection (IEC/EN 60529)			IP20	IP20
Vibrations (IEC/EN 60068-2-6)				
Constant amplitude 0.15 mm		Hz	10 – 57	10 – 57
Constant acceleration, 2 g		Hz	57 – 150	57 – 150
Mechanical shock resistance (IEC/EN 60068-2-27) semi-sinusoidal 15 g/11 ms		Impacts	18	18
Drop to IEC/EN 60068-2-31	Drop height	mm	50	50
Free fall, packaged (IEC/EN 60068-2-32)		m	1	1
Mounting position			Horizontal/vertical	Horizontal/vertical
Electromagnetic compatibility (EMC)				
Electrostatic discharge (IEC/EN 61000-4-2, Level 3, ESD)				
Air discharge		kV	8	8
Contact discharge		kV	6	6
Electromagnetic fields (IEC/EN 61000-4-3, RFI)		V/m	10	10
Radio interference suppression (EN 55011)			EN 55011 Class B, EN 55022 Class B	
Burst pulses (IEC/EN 61000-4-4, level 3)				
Supply cables		kV	2	2
Signal lines		kV	2	2
High-energy pulses (surge) (IEC/EN 61000-4-5)		kV	2 (supply cables, symmetrical)	
High-energy pulses (surge) (IEC/EN 61000-4-5, level 2)		kV	0.5 (supply cables, symmetrical)	
Immunity to line-conducted interference (IEC/EN 61000-4-6)		V	10	10
Insulation resistance				
Clearance in air and creepage distances			EN 50178, UL 508, CSA C22.2, No. 142	
Insulation resistance			EN 50178	EN 50178



Moeller HPL0213-2004/2005

			MFD-AC-CP8..
Power supply			
Rated operational voltage	U_e	V	100/110/115/120/230/240 AC (+10/-15 %)
Admissible range		V AC	85 – 264
Frequency		Hz	50/60 (\pm 5%)
Input current			
At 115/120 V AC 60 Hz		mA	Normally 90
At 230/240 V AC 50 Hz		mA	Normally 60
Voltage dips (IEC/EN 61131-2)		ms	10
Power loss			
At 115/120 V AC		VA	Normally 11
At 230/240 V AC		VA	Normally 15

			MFD-CP8..	MFD-CP4...
Power supply				
Rated operational voltage	U_e	V	24 DC (-15/+20 %)	24 DC (-15/+20 %)
Admissible range		V DC	20.4 – 28.8	20.4 – 28.8
Residual ripple		%	\leq 5	\leq 5
Input current				
At 24 V DC		mA	Normally 200	Normally 185
Voltage dips (IEC/EN 61131-2)		ms	10	10
Heat dissipation at 24 V DC		W	3.4	1.5

			MFD-CP4...	
Point-to-point connection				
Stations			1	
Data transfer rate				
easy500, easy700			9.6 kBaud	
easy800, MFD			19.2 kBaud	
Distance		m	Max. 5	
Potential isolation				
From power supply			Yes	
From the connected device			Yes	
Terminations			Cage clamp terminals	

			MFD-CP8-NT, MFD-AC-CP8-NT	
NET network				
Stations		Quantity	Max. 8	
Data transfer rate/distance			1000 kBit/s, 6 m 500 kBit/s, 25 m 250 kBit/s, 40 m 125 kBit/s, 125 m 50 kBit/s, 300 m 20 kBit/s, 700 m 10 kBit/s, 1000 m	
Potential isolation				
From power supply			Yes	
From the inputs			Yes	
From the outputs			Yes	
From the PC interface, memory card NET network, EASY-Link			Yes	
Bus termination (first and last station)			Yes	
Terminations			RJ45, 8-pole	



		MFD-TA..., MFD-RA..
Analog outputs		
Quantity		1
Potential isolation		
From power supply		No
From the digital inputs		No
From the digital outputs		Yes
From the PC interface, memory card NET network, EASY-Link		Yes
Type of output		DC voltage
Signal range	V DC	0 – 10
Max. output current	A	0.01
Load resistance		1 kΩ
Overload and short-circuit protection		Yes
Resolution, analog	V DC	0.01
Resolution, digital	Bit	10, (value: 0 – 1023)
Recovery time	μs	100
Accuracy		
–25 °C to 55 °C	%	2
25 °C	%	1
Conversion time		Every CPU cycle

		MFD-T..., MFD-R...
Analog inputs		
Quantity		4 (I7, I8, I11, I12)
Potential isolation		
From power supply		No
From the digital inputs		No
From the outputs		Yes
From the PC interface, memory card NET network, EASY-Link		Yes
Type of input		DC voltage
Signal range	V DC	0 – 10
Resolution, analog	V	0.01
Resolution, digital	V	0.01
Resolution	Bit	10 (value 0 – 1023)
Input impedance	kΩ	11.2
Accuracy of actual value		
2 MFD devices	%	± 3
Within a single device	%	± 2
Conversion time, analog/digital	ms	Every CPU cycle
Input current	mA	< 1
Cable length screened	m	< 30

		MFD-AC-R16
Digital inputs 115/230 V AC		
Quantity		12
Status indication		LCD display (if provided)
Potential isolation		
From power supply		No
Between digital inputs		No
From the outputs		Yes
From the PC interface, memory card NET network, EASY-Link		Yes
Rated voltage L (sinusoidal)		
At signal "0"	V AC	0 – 40
At signal "1"	V AC	79 – 264
Rated frequency	Hz	50 – 60
Input current at signal "1"		
I1 - I12	mA	12 × 0.2 (at 115 V AC, 60 Hz), 12 × 0.5 (at 230 V AC, 50 Hz)
Delay time		
Delay time (0 – 1/1 – 0) I1 - I12, 50/60 Hz		10/100
Max. admissible cable length (per input)		
I1 - I12	m	Normally 60



Moeller HPL0213-2004/2005

			MFD-T..., MFD-R...
Digital inputs 24 V DC			
Quantity			12
Inputs can be used as analog inputs			4 (I7, I8, I11, I12)
Potential isolation			
From power supply			No
Between digital inputs			No
From the outputs			Yes
From the PC interface, memory card, NET network, EASY-Link			Yes
Rated operational voltage	U_e	V DC	24
At signal "0"	U_e	V DC	< 5.0 (I1 – I6, I9 – I10), < 8 (I7, I8, I11, I12)
At signal "1"	U_e	V DC	> 15.0 (I1 – I6, I9 – I10), > 8.0 (I7, I8, I11, I12)
Input current at signal "1"			
I1 to I6		mA	3.3 (at 24 V DC)
I7, I8		mA	2.2 (at 24 V DC)
I9, I10		mA	3.3 (at 24 V DC)
I11, I12		mA	2.2 (at 24 V DC)
Delay time from 0 to 1			
Debounce ON		ms	20
Debounce OFF		ms	Normally 0.1 (I1 – I4), normally 0.25 (I5 – I12)
Delay time from 1 to 0			
Debounce ON		ms	20
Debounce OFF		ms	Normally 0.1 (I1 – I4), normally 0.4 (I5, I6, I9, I10), normally 0.2 (I7, I8, I11, I12)
Cable length (unscreened)		m	100
Frequency counter			4 (I1, I2, I3, I4)
Counter frequency		kHz	< 3
Pulse shape			Square
Pulse pause ratio			1:1
Incremental counter			2 (I1 + I2, I3 + I4)
Counter frequency		kHz	< 3
Pulse shape			Square
Signal offset			90°
Pulse pause ratio			1:1
High-speed counter inputs			4 (I1, I2, I3, I4)
Counter frequency		kHz	< 3
Pulse shape			Square
Pulse pause ratio			1:1
Cable length, screened		m	< 20



MFD Multi-Function Displays

Moeller HPL0213-2004/2005

MFD-R.., MFD-AC-R..

Relay outputs			
Quantity			4
Parallel switching of outputs to increase performance			Not permissible
Protection of an output relay			Miniature circuit-breaker B16 or fuse 8 A (slow)
Potential isolation			
From power supply			Yes
From the inputs			Yes
From the PC interface, memory card NET network, EASY-Link			Yes
Safe isolation		V AC	300
Basic insulation		V AC	600
Lifespan, mechanical	Operations	$\times 10^6$	10
Contacts			
Conventional thermal current (10 A UL)		A	8
Recommended for load: 12 V AC/DC		mA	> 500
Short-circuit proof $\cos \varphi = 1$, characteristic B16 at 600 A		A	16
Short-circuit proof $\cos \varphi = 0.5 - 0.7$; characteristic B16 at 900 A		A	16
Rated impulse withstand voltage U_{imp} contact to coil		kV	6
Rated operational voltage	U_e	V AC	250
Rated insulation voltage	U_i	V AC	250
Safe isolation to EN 50178 between coil and contact		V AC	300
Safe isolation to EN 50178 between 2 contacts		V AC	300
Making capacity			
AC-15, 250 V AC, 3 A (600 ops./h)	Operations		300000
DC-13, L/R ≤ 150 ms, 24 V DC, 1 A (500 ops./h)	Operations		200000
Breaking capacity			
AC-15, 250 V AC, 3 A (600 ops./h)	Operations		300000
DC-13, L/R ≤ 150 ms, 24 V DC, 1 A (500 ops./h)	Operations		200000
Filament bulb load			
1000 W at 230/240 V AC	Operations		25000
500 W at 115/120 V AC	Operations		25000
Fluorescent lamp load			
Fluorescent lamp load 10×58 W at 230/240 V AC			
With series-connected electrical device	Operations		25000
Uncompensated	Operations		25000
Fluorescent lamp load 1×58 W at 230/240 V AC conventionally compensated	Operations		25000
Switching frequency			
Mechanical operations		$\times 10^6$	10
Switching frequency		Hz	10
Resistive load/lamp load		Hz	2
Inductive load		Hz	0.5
UL/CSA			
Uninterrupted current at 240 V AC		A	10
Uninterrupted current at 24 V DC		A	8
AC			
Control circuit rating codes (utilization category)			
Max. rated operational voltage		V AC	300
Max. thermal uninterrupted current at B 300		A	5
Max. make/break capacity at B 300		VA	3600/360
DC			
Control circuit rating codes (utilization category)			
Max. rated operational voltage		V DC	300
Max. thermal uninterrupted current at R 300		A	1
Max. make/break capacity at R 300		VA	28/28



Moeller HPL0213-2004/2005

			MFD-T..
Transistor outputs			
Quantity			4
Rated operational voltage	U_e	V DC	24
Admissible range	U_e	V DC	20.4 – 28.8
Residual ripple		%	–
Supply current			
At signal "0"	Normally/ max.	mA	18 – 32
At signal "1"	Normally/ max.	mA	24 – 44
Protection against polarity reversal			Yes caution: A short circuit will occur if voltage is applied to the outputs on account of reverse polarity).
Potential isolation			
From power supply			Yes
From the inputs			Yes
From the PC interface, memory card NET network, EASY-Link			Yes
Rated operational current at signal "1" DC	I_e	A	Max. 0.5
Lamp load without R_v		W	5 (Q1 – Q4)
Residual current at signal "0" per channel		mA	< 0.1
Max. output voltage			
With condition "0" at external load < 10 M Ω		V	2.5
With condition "1" at $I_e = 0.5$ A		V	$U = U_e - 1$ V
Short-circuit protection			Thermal (Q1 – Q4), (analysis via diagnostics input I16)
Short-circuit tripping current for $R_a \leq 10$ m Ω		A	$0.7 \leq I_e \leq 2$
Total short-circuit current		A	8
Peak short-circuit current		A	16
Thermal cutout			Yes
Max. operating frequency at constant resistive load $R_L < 100$ k Ω (dependent on program and load)		Ops/h	40000
Parallel connection of outputs			
With resistive load, inductive load with external suppressor circuit, combination within a group			Group 1: Q1 to Q4
Number of outputs	Max.		4
Total max. current		A	2 (Caution! Outputs must be actuated simultaneously and for the same length of time.)
Inductive load			
Without external suppressor circuit			
$T_{0.95} = 1$ ms, $R = 48$ Ω , $L = 16$ mH			
Utilization factor		g	0.25
Duty factor		% DF	100
Max. operating frequency $f = 0.5$ Hz (max. DF = 50 %)		Operations	1500
DC13, $T_{0.95} = 72$ ms, $R = 48$ Ω , $L = 1.15$ H			
Utilization factor		g	0.25
Duty factor		% DF	100
Max. operating frequency $f = 0.5$ Hz (max. DF = 50 %)		Operations	1500
$T_{0.95} = 15$ ms, $R = 48$ Ω , $L = 0.24$ H			
Utilization factor		g	0.25
Duty factor		% DF	100
Max. operating frequency $f = 0.5$ Hz (max. DF = 50 %)		Operations	1500
With external suppressor circuit			
Utilization factor		g	1
Duty factor		% DF	100
Max. switching frequency, max. duty factor		Operations	Depending on the suppressor circuit



EASY2...

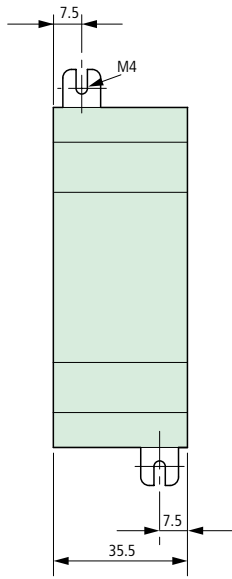

EASY5...

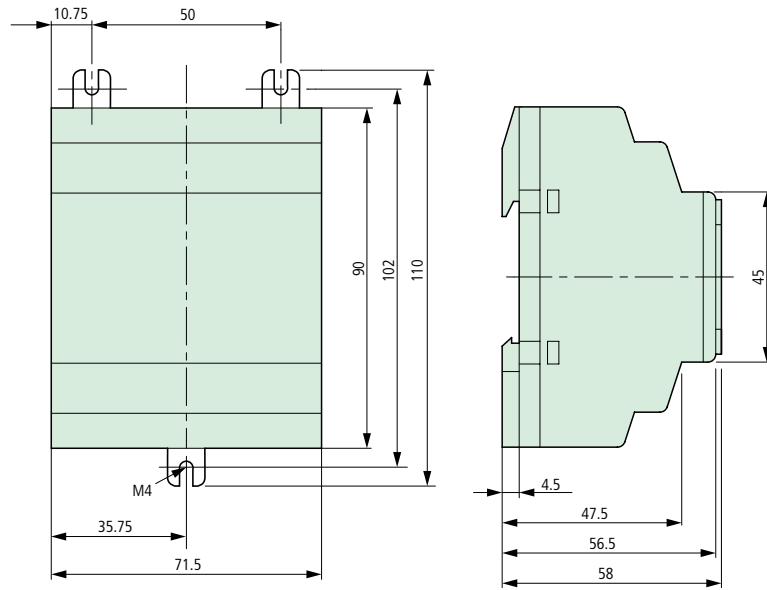

EASY7...

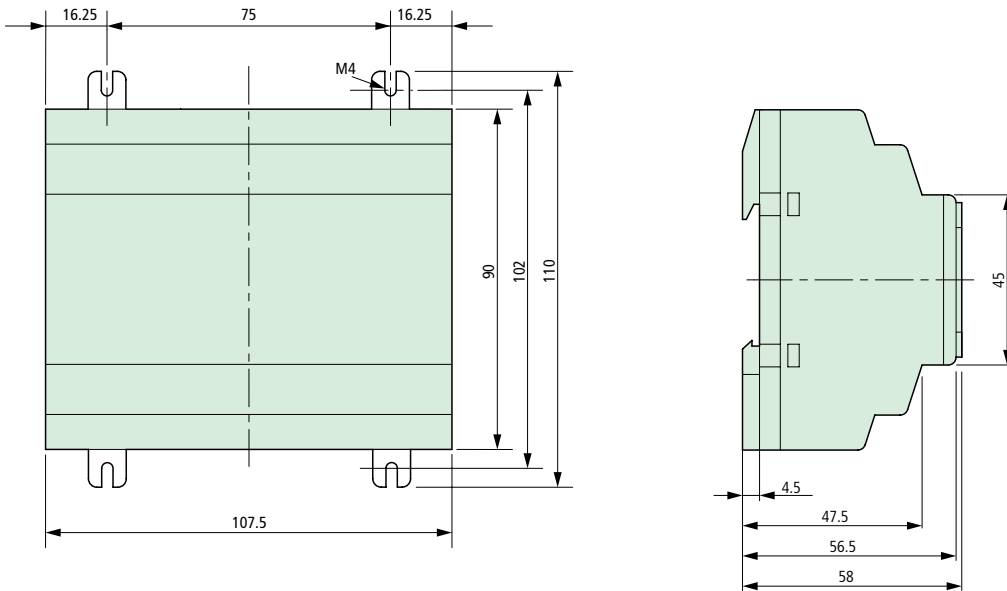

EASY8..

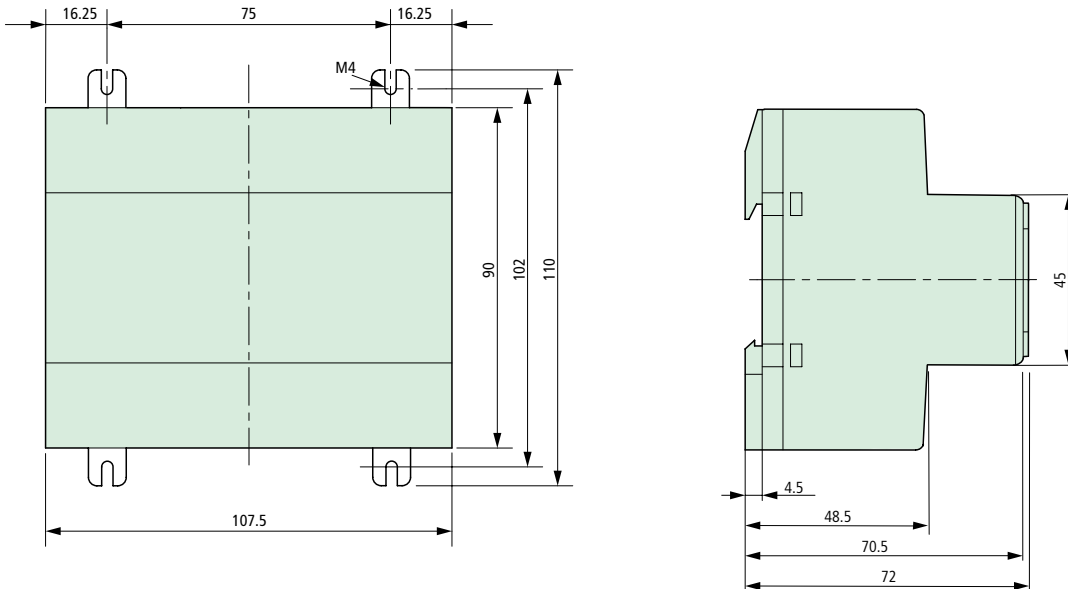

Moeller HPL0213-2004/2005

MFD-80...

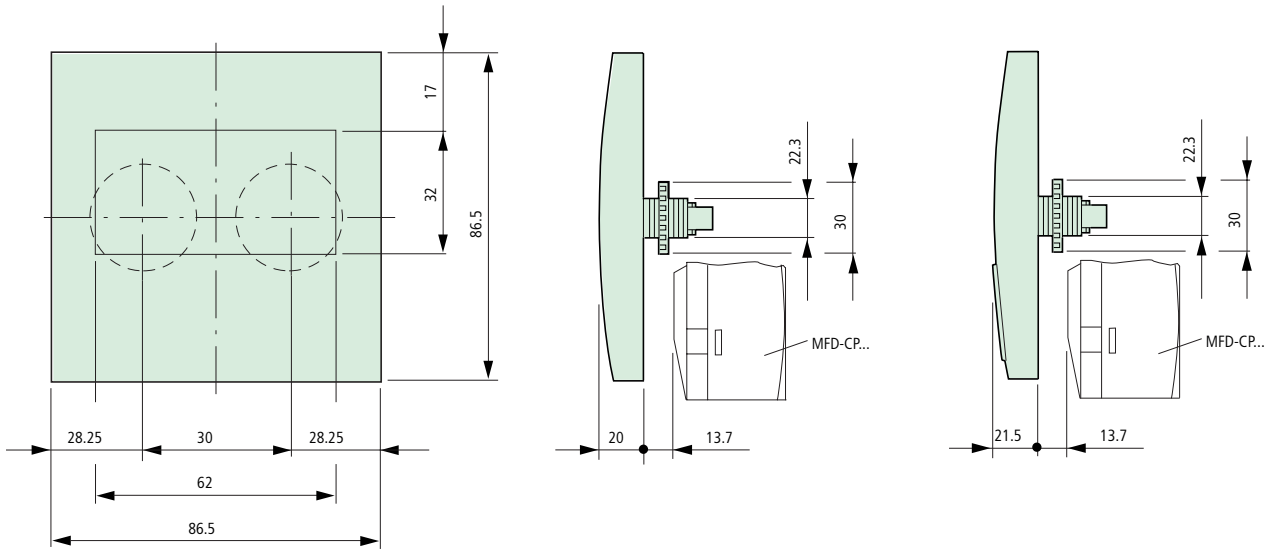

MFD-CP..., MFD-AC-CP...

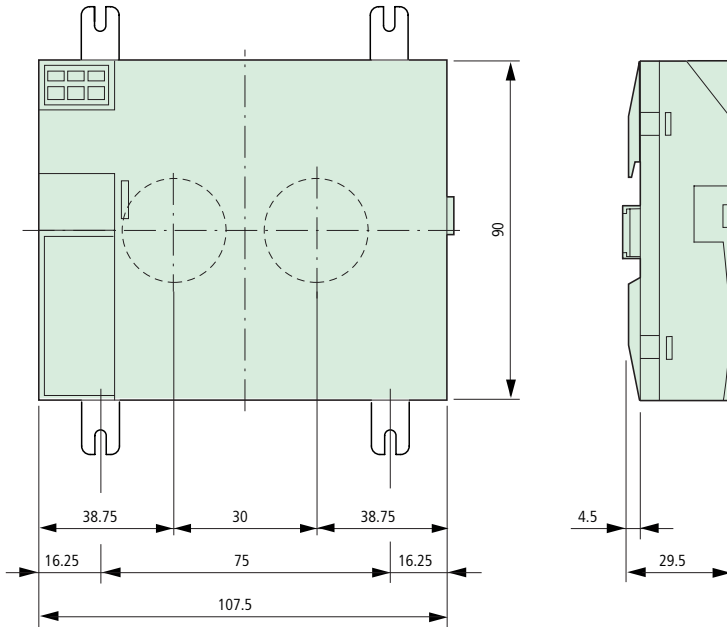

MFD-R..., MFD-T..., MFD-AC-R

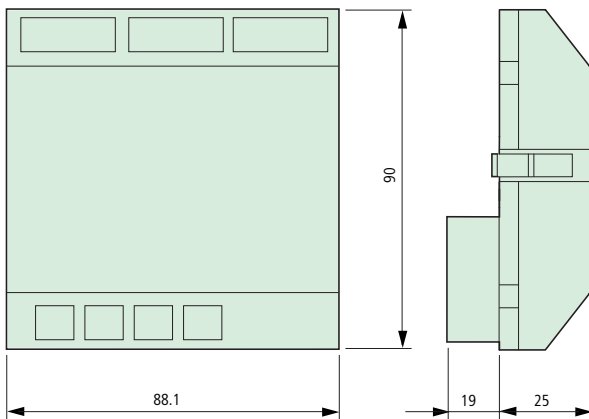

easy Control Relays, MFD

MFD-80... + MFD-CP... + MFD-R.../MFD-T...
MFD-80... + MFD-AC-CP... + MFD-AC-R...

MFD-80...+ MFD-CP4...

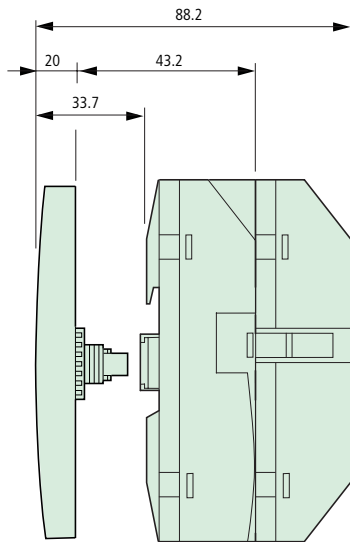
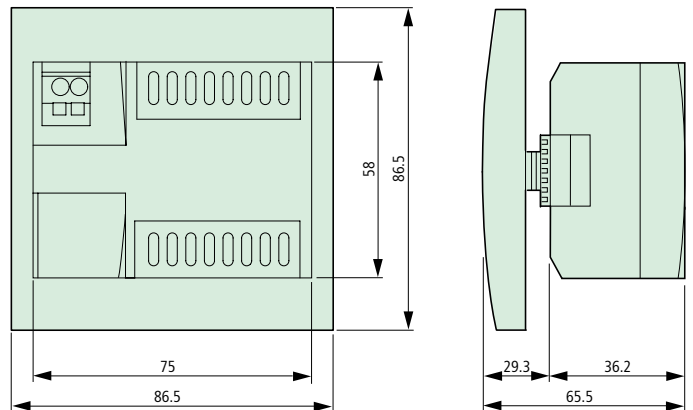
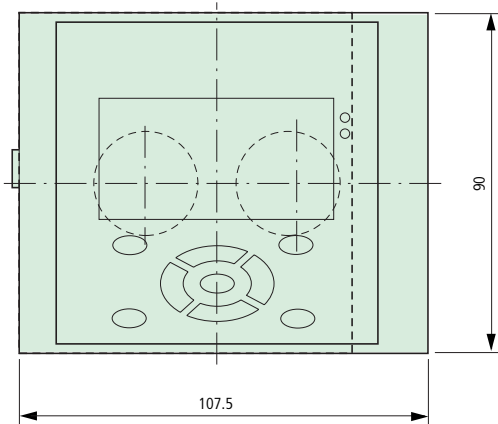

SKF hinged inspection window

SKF-FF4

SKF-FF6

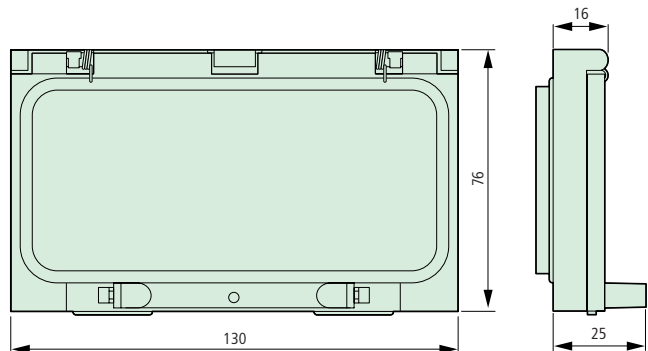
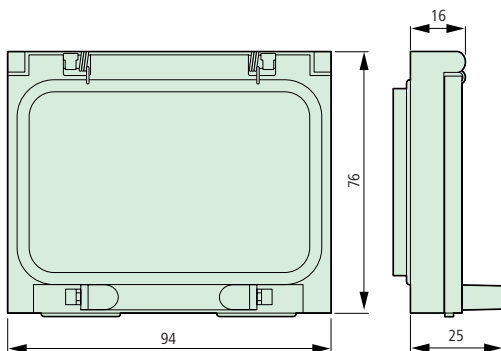

Moeller HPL0213-2004/2005

Top-hat rail adapter for hinged inspection window

SKF-HA

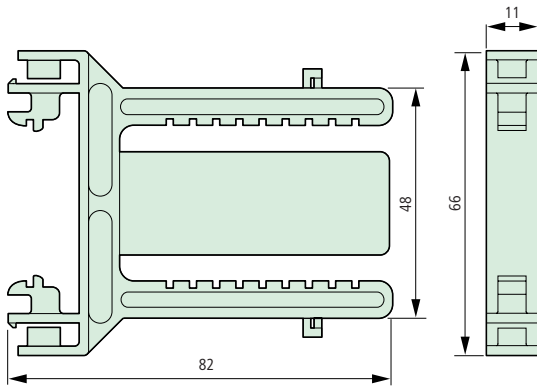

Protective membrane

MFD-XM-80

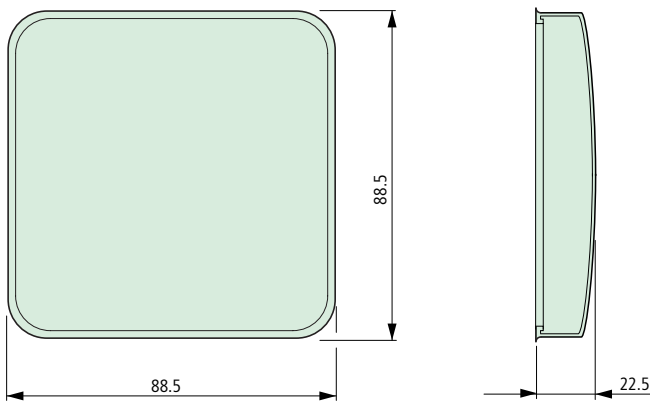

Protective cover, transparent

MFD-XS-80

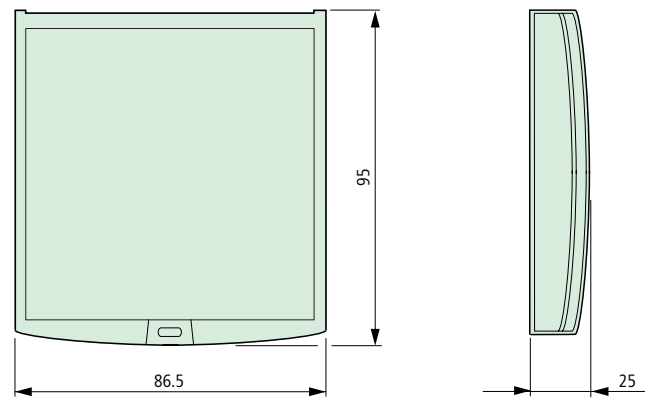

Mounting rail

MFD-TS-144

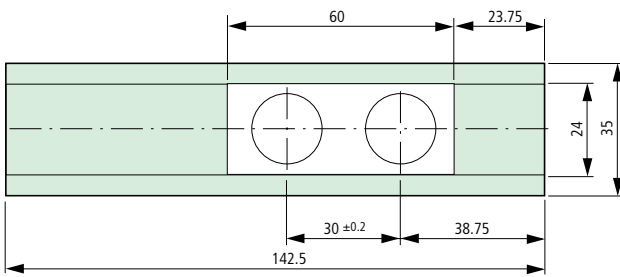

easy Control Relays, MFD

