

DPA Series Pressure Sensor Instruction Sheet

Thank you very much for choosing Delta DPA series pressure sensor. Please read this instruction sheet carefully before using your DPA. Keep this instruction sheet handy for quick reference.

■ Warning

⚠ DANGER! CAUTION! ELECTRIC SHOCK!

⚠ DPA is a pressure measurement device. DO NOT use it out of its specification. Improper pressure or incorrect wiring may cause series injuries on staff or damages on other devices.

- Keep away from high-voltage and high-frequency environment during the installation in case of interference. Prevent using the device in premises which contain:
 - dust or corrosive gas;
 - high humidity and high radiation;
 - shock and vibration.
- DPA can only be used for air pressure measurement and should avoid corrosive, inflammable or toxic gas measurement.
- Make sure the power supply is switched off when installing or dismantling DPA and the pressure source stops its action in case harms occur on human body and properties.
- DO use parts compatible to the specification of the pressure pore for connection to avoid mistaken measurement or safety problems.
- Before switching on the power supply, check the signal connection, e.g. the input voltage and polarity. Voltage that is too high may cause damages on DPA.
- DO use dry cloth and DO NOT use acid or alkaline liquid to clean the device.

■ Product Profile & Outline

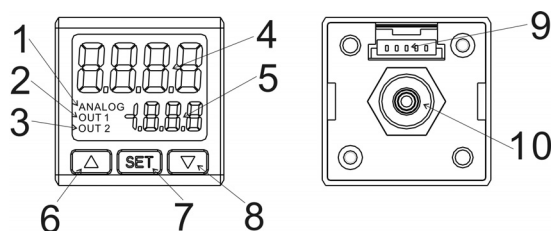

1. Analog output indicator	6. UP key
2. Digital output 1 indicator	7. SET key
3. Digital output 2 indicator	8. DOWN key
4. Pressure/parameter display	9. Power supply and output terminals
5. SV/setup item display	10. Pressure input pore

- Contents in the pack: Pressure sensor, signal wire, unit sticker, instruction sheet
- Optional accessories: Panel mounting parts, metal mounting parts

■ Ordering Information

DPA 1 2 3 - 4

Series name	DPA: Delta DPA series pressure sensor
1 2 Measurable pressure range	01: -100kPa ~ 100kPa 10: -100kPa ~ 1,000kPa
3 Output types	N: NPN output + 4 ~ 20mA; P: PNP output + 4 ~ 20mA M: NPN output + 1 ~ 5V; Q: PNP output + 1 ~ 5V
4 Pressure pore types	P: Outer pore PT 1/8, inner pore M5 N: Outer pore NPT 1/8, inner pore M5 G: Outer pore G 1/8, inner pore M5

■ Electrical Specifications

Power supply	Voltage range	12 ~ 24V DC +/- 10% no isolation
	Power consumption	40mA Max.; current output type 60mA Max.
Pressure measurement	Pressure type	Non-corrosive gas, gauge type
	Measurable range	DPA01: -100kPa ~ 100kPa
		DPA10: -100kPa ~ 1,000kPa
	Max. durable pressure	DPA01: 200kPa
		DPA10: 1,500kPa
Accuracy	+/- 3% entire process	
Temperature inaccuracy	+/- 2% entire process	
Display	Setup display	2-line LCD display, 4 digits for measured value and 3.5 digits for setup display
	Status display	LCD output status display
	Display mode	3 colors for different modes
	Cycle	100ms, 250ms, 500ms, 1,000ms
Output	Number of outputs	Built-in 2 NPN or PNP transistor digital outputs and 1 analog output
	Transistor output	NPN: Max. durable pressure 30V/100mA, residual voltage 1.5V
		PNP: Max. durable pressure 30V/100mA, residual voltage 1.5V
	Analog output	1 ~ 5V: Min. output load resistance 1,000Ω
		4 ~ 20mA: Max. output load resistance 400Ω; linear inaccuracy < 2% entire process
Response time	2ms, 4ms, 10ms, 30ms, 50ms, 100ms, 250ms, 500ms, 1,000ms, 5,000ms	
Output inaccuracy	Linear inaccuracy: < +/- 2% entire process	
Pore size	P	Outer pore PT 1/8, inner pore M5
	N	Outer pore NPT 1/8, inner pore M5
	G	Outer pore G 1/8, inner pore M5
Shock immunity	10 ~ 500Hz, 10mm 3 axes for 2 hours	
Vibration immunity	Max. 100m/ s ² 3 axes 6 directions, 3 times each	
Ambient temperature	0°C ~ +50°C	
Storage temperature	-20°C ~ +65°C	
Altitude	< 2,000m	
Ambient humidity	35% ~ 80% RH (non-condensing)	

■ How to Set up Parameters

- **Switching modes:** DPA will be in the “Measuring Mode” when it is switched on, displaying PV and SV. Press **SET** for more than 2 seconds in this mode to switch to the “Quick Setup Mode”. Press **SET** for more than 4 seconds in the “measuring mode” to switch to “Advanced Setup Mode”. Press **SET** in the “Quick Setup Mode” or “Advanced Setup Mode” to return to the “Measuring Mode”.
- **Setting up parameters:** In the three modes, press **SET** once to select the parameter to set up. When you find the parameter to be set up or modify, use **▲** **▼** to modify the setting.

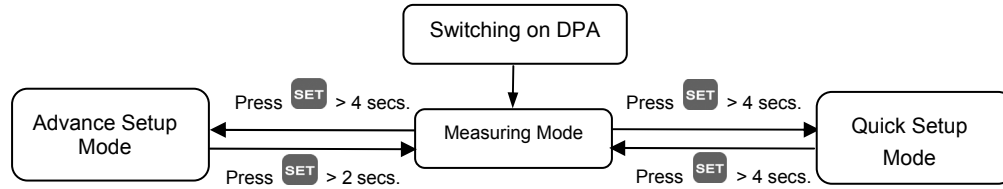

• Quick Setup Mode:

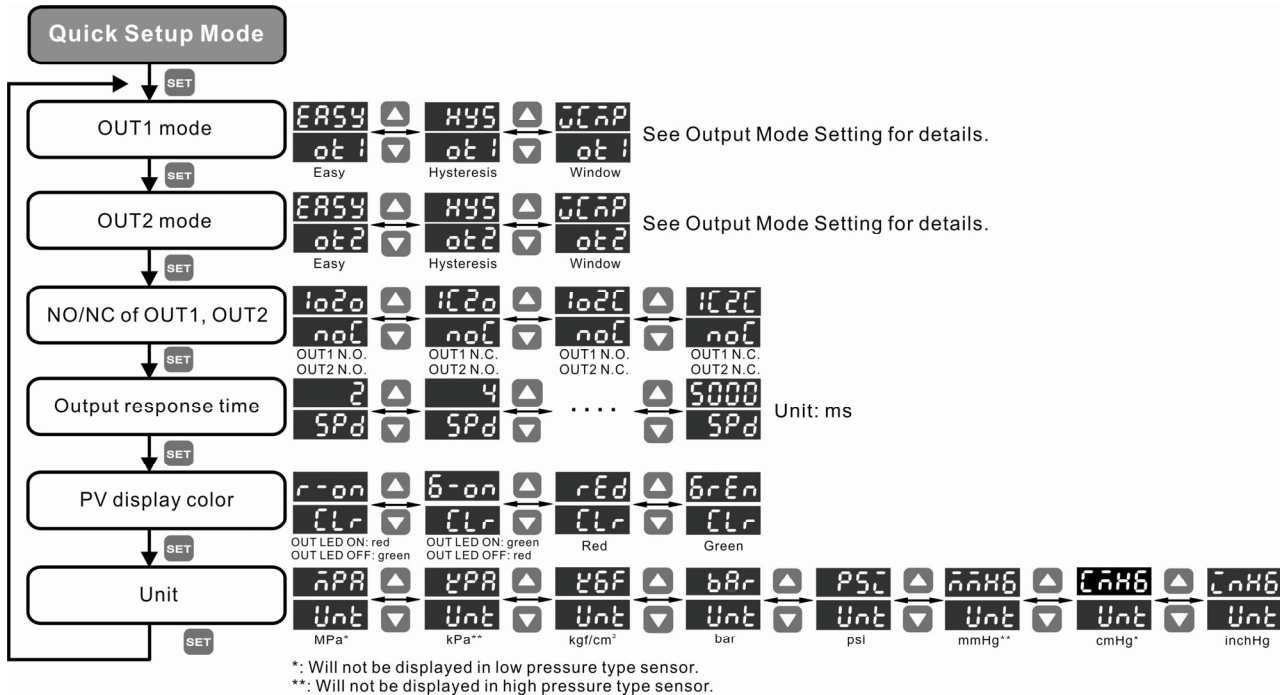

• Advanced Setup Mode:

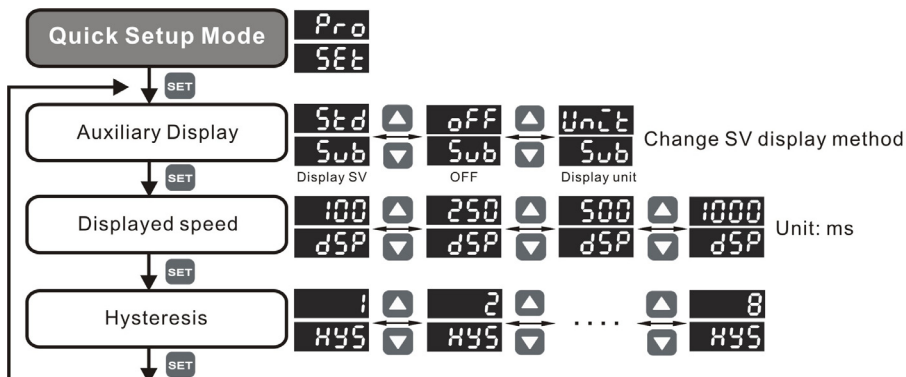

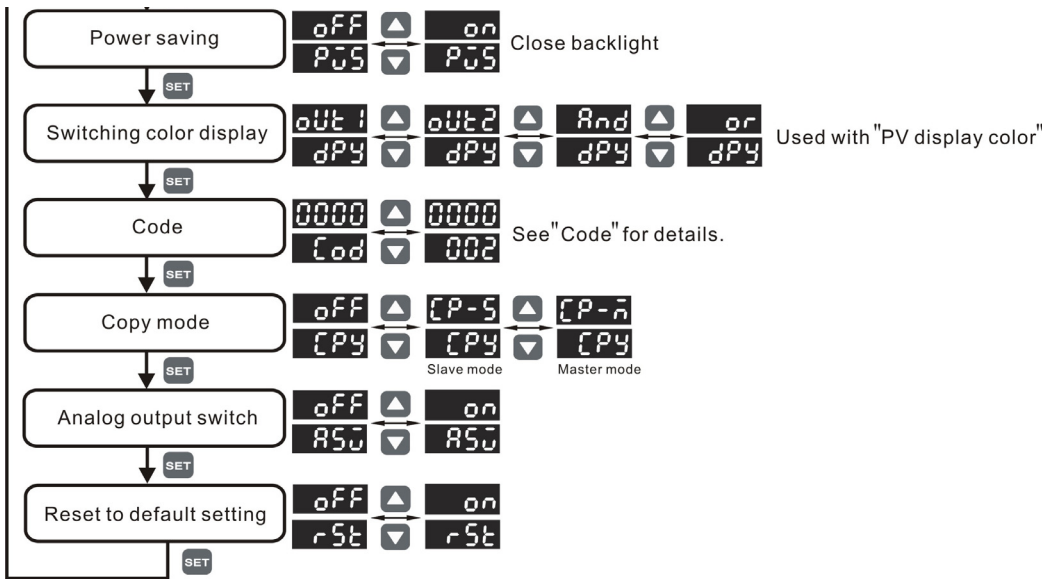

• Measuring Mode:

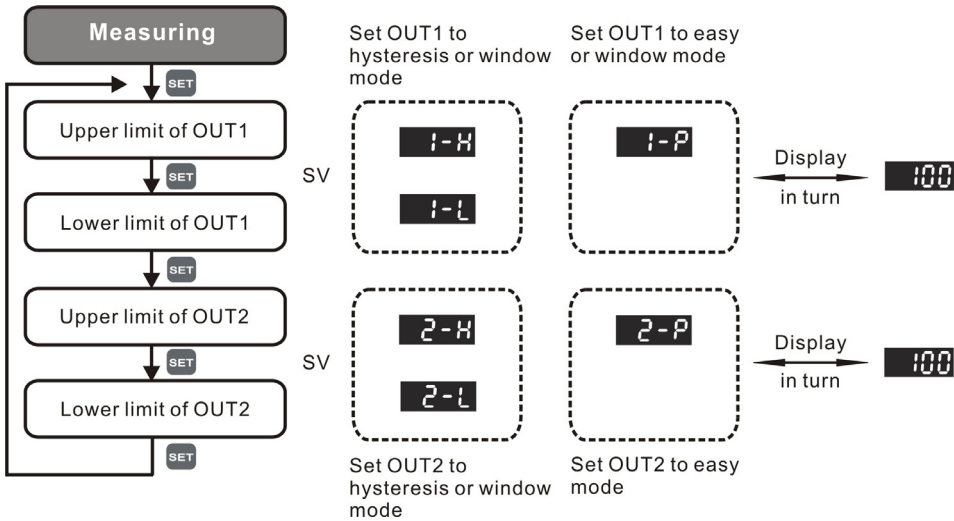

Quick Setup Mode	Advanced Setup Mode	Measuring Mode
ot1 Set up OUT1 mode Press SET ▾	Sub Set up auxiliary display (Change SV display method) Press SET ▾	1-H Set up upper limit of OUT1 (Set OUT1 to hysteresis mode / window mode) Press SET ▾
ot2 Set up OUT2 mode Press SET ▾	dSP Set up displayed speed Press SET ▾	1-L Set up lower limit of OUT1 (Set OUT1 to hysteresis mode / window mode) Press SET ▾
noC Set up N.O./N.C. of OUT1 and OUT2 Press SET ▾	HYS Set up hysteresis Press SET ▾	1-P SV of OUT1 (Set OUT1 to easy mode) Press SET ▾

Quick Setup Mode	Advanced Setup Mode	Measuring Mode
SPd Set up output response time Press SET ▾	PS Set up power saving mode Press SET ▾	2-H Set up upper limit of OUT2 (Set OUT2 to hysteresis mode / window mode) Press SET ▾
CLr Set up PV display color Press SET ▾	dPY Set up switching color referencing output items Press SET ▾	2-L Set up lower limit of OUT2 (Set OUT2 to hysteresis mode / window mode) Press SET ▾
Unit Set up unit Press SET ▷ Return to “set up OUT1 mode”	cod Set up code Press SET ▾	2-P SV of OUT2 (Set OUT2 to easy mode) Press SET ▷ Returning to output setting
	CPY Set up copy function Press SET ▾	
	ASO Set up analog output switch Press SET ▾	
	rSt Return to default settings Press SET ▷ Return to “set up auxiliary display”	

■ Initial Setting

- Units: DPA provides many units for users, including kPa, kgf/cm², bar, psi, mmHg and inchHg. In the easy mode, you can press **SET** and find **Unit** to set the unit to the desired one.
- Output status: You can set up 2 output status in DPA, N.O. (normally open) and N.C. (normally closed). In the easy mode, you can press **SET** and find **noC** to set up the output status for OUT1 and OUT2.
- Response time: Referring to the time required for the pressure to reach output status. For example, “50” refers to once the pressure has reached the output status, it has to last for 50ms before the output starts to operate. In the easy mode, press **SET** and find **SPd**. Use **▲** **▼** to set up the response time.

■ Output Mode Setting

There are 3 output modes in DPA: Easy, Hysteresis and Window

- Easy Mode: Set up pressure P. When the pressure measured is bigger than (P + dP), the output will be ON. When the pressure measured is smaller than P, the output will be OFF. (See Figure 1: Output in Easy Mode)
 - In the “Measuring Mode”, press **SET** and find **1-P** (OUT1) and **2-P** (OUT2). Use **▲** **▼** to set up P value.
 - In the “Advanced Setup Mode”, press **SET** and find **HYS**. Use **▲** **▼** to set up “dP” value.

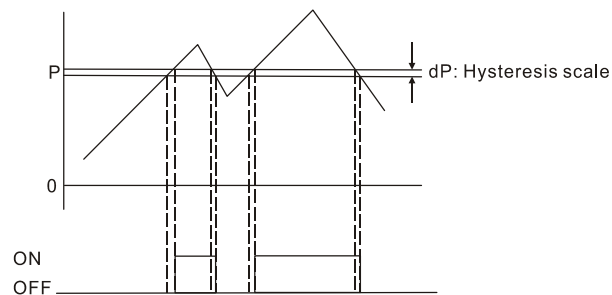

[Figure 1: Output in Easy Mode]

- Hysteresis Mode: Set up pressure Hi/Lo. When the pressure measured is bigger than the Hi value, the output will be ON. When the pressure measured is smaller than the Lo value, the output will be OFF. (See Figure 2: Output in Hysteresis Mode)

- In the “Measuring Mode”, press **SET** and find **1-H** (OUT1 Hi), **1-L** (OUT1 Lo), **2-H** (OUT2 Hi) and **2-L** (OUT2 Lo). Use **▲** **▼** to set up Hi/Lo values.

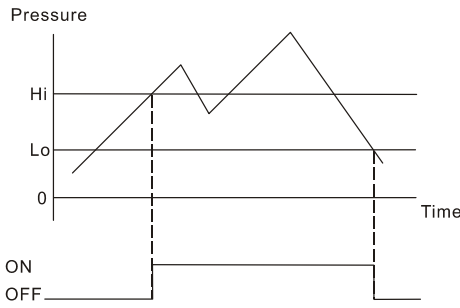

[Figure 2: Output in Hysteresis Mode]

3. Window Mode: Set up pressure Hi/Lo. When the pressure measured is bigger than Hi or smaller than Lo, the output will be OFF. When the pressure measured is bigger than Lo and smaller than Hi, the output will be ON. (See Figure 3: Output in Window Mode)

- In the “Measuring Mode”, press **SET** and find **1-H** (OUT1 Hi), **1-L** (OUT1 Lo), **2-H** (OUT2 Hi) and **2-L** (OUT2 Lo). Use **▲** **▼** to set up Hi/Lo values.

- In the “Advanced Setup Mode”, press **SET** and find **495**. Use **▲** **▼** to set up “dP” value.

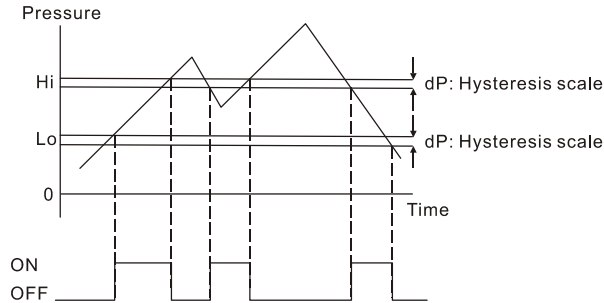

[Figure 3: Output in Window Mode]

Note: Supposed the output is ON and the output status is set to N.O. (normally open), the output will then be off. If the output status is set to N.C (normally closed), the output will then be on. Supposed the output is OFF and the output status is set to N.O., the output will then be on. If the output status is set to N.C., the output will then be off.

■ Zero Returning

In the “Measuring Mode”, press **▲** **▼** together, and you will see **0000** **RdU**. The zero returning will start. Release the keys to end the zero returning.

■ Analog Output

When the input pressure starts to change, the analog output will change with the input. For example, supposed the range for input is -100kPa ~ 100kPa, and DPA reads -100kPa, the output will be 4mA or 1V. When DPA reads 100kPa, the output will be 20mA or 5V. (See Figure 4: Analog Output)

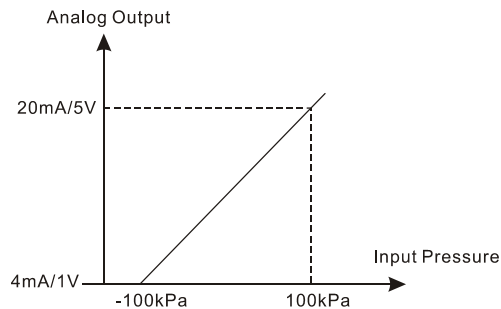

[Figure 4: Analog Output]

■ Key Locking Function

- Lock On: Press **SET** and **▲** together for 2 seconds until **LoCK on** is displayed. You will then see the display of pressure value (PV) and set value (SV).
- Lock Off: Press **SET** and **▼** together for 2 seconds until **LoCK off** is displayed. You will then see the display of pressure value (PV) and set value (SV).
- Lock Display: Press any key in the key locking mode, and you will see the display of pressure value (PV) and **LoCK** (SV). Release the key, and the PV and SV will return to original values.

■ Switching Colors

In DPA, different output statuses can have different display colors. The output statuses for DPA are “OUT1”, “OUT2”, “OUT1 and OUT2”, “OUT1 or OUT2”. See below explanations for how to set:

1. Setting up output status: In the “Measuring Mode”, press **SET** for more than 4 seconds and release the key after you see **Pro Set**. You are now in the “Advanced Setup Mode”. Press **SET** for 5 times and find the switching color referencing items (see Advanced Setup Mode chart). Use **▲** **▼** to select the referencing item you'd like.
2. Switching colors: In the “Measuring Mode”, press **SET** for more than 2 seconds to enter the “Quick Setup Mode”. Press **SET** for 5 times and find the parameter for setting up colors (see Quick Setup Mode chart). Use **▲** **▼** to select the color you'd like.

Note: “OUT1 and OUT2” will be ON only when both OUT1 and OUT2 are ON; otherwise, it will be OFF. “OUT1 or OUT2” will be OFF only when both OUT1 and OUT2 are OFF; otherwise, it will be ON.

■ Copy Function

DPA is able to copy the parameters in the master device to another slave device.

1. Hardware: Connect Pin 2 on master to Pin 3 on slave; Pin 3 on master to Pin 2 on slave; Pin 5 on master and slave to GND on power supply; Pin 1 on master and slave to +24V on power supply.
2. Software:

- a) Slave device: In the “Measuring Mode”, press **SET** for more than 4 seconds and release the key after you see **Pro Set**. You are now in the “Advanced Setup Mode”. Press **SET** for 7 times and find the parameter for setting up the copy function (see Advanced Setup Mode chart). Use **▲** **▼** to select **CP-S** (**CP-S** refers to Copy-Slave).
- b) Master device: In the “Measuring Mode”, press **SET** for more than 2 seconds and release the key after you see **Pro Set**. You are now in the “Advanced Setup Mode”. Press **SET** for 7 times and find the parameter for setting up the copy function (see Advanced Setup Mode chart). Use **▲** **▼** to select **CP-M** (**CP-M** refers to Copy-Master). Next, press **SET** for more than 2 seconds and return to the “Measuring Mode”. Now, you will see **Cnt** on the screen and **Cnt** on the slave device, indicating that the two devices have been connected. On **Cnt**, you will see numbering counting up, referring to the number of parameters transmitted successfully between the two devices. Once the copy of parameter succeeds, you will see **CP-M ok** on the master device and **CP-S ok** on the slave device. That the number at **ok** stays intact refers to the copy fails.

After the copy is completed, switch off the two devices and connect them again to the power supply.

■ Code

DPA offers codes for the user to set up. In the “Measuring Mode”, press **SET** for more than 4 seconds and release the key after you see **Pro Set**. You are now in the “Advanced Setup Mode”. Press **SET** for 6 times to find the parameter to set up codes (see Advanced Setup Mode chart). **cod** → **000** displays in turn.

See the meanings of codes in the table below:

Code	1 st digit		2 nd digit		3 rd digit	4 th digit	
	OUT1 mode	N.O./N.C.	OUT2 mode	N.O./N.C.	Response time	Color	Referencing item for color
0	Easy	N.O.	Easy	N.O.	2ms	Red when ON	OUT1
		N.C.		N.C.	4ms		OUT2
1	Hysteresis	N.O.	Hysteresis	N.O.	10ms		OUT1 and OUT2
		N.C.		N.C.	30ms		OUT1 or OUT2
2	Window	N.O.	Window	N.O.	50ms	Green when ON	OUT1
		N.C.		N.C.	100ms		OUT2
3	-	-	-	-	250ms		OUT1 and OUT2
4	-	-	-	-	500ms		OUT1 or OUT2
5	-	-	-	-	1,000ms	Red	OUT1
6	-	-	-	-	-		OUT2
7	-	-	-	-	-		OUT1 and OUT2
8	-	-	-	-	-	Red	OUT1 or OUT2
9	-	-	-	-	-		OUT1
A	-	-	-	-	-	Green	OUT2
B	-	-	-	-	-		OUT1 and OUT2
C	-	-	-	-	-		OUT1 or OUT2

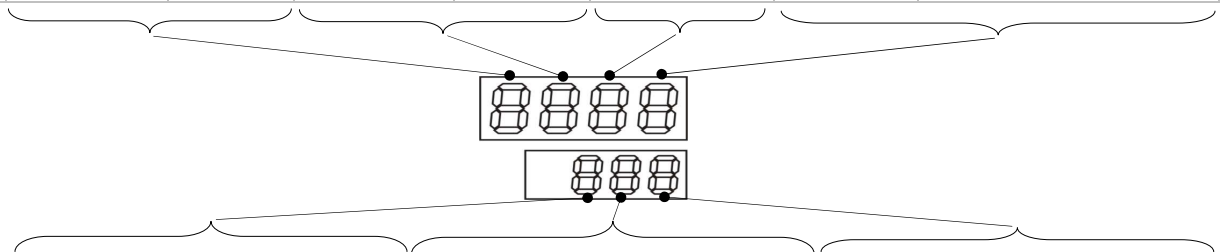

Code	6th digit	7th digit		8th digit
	Pressure unit	Speed	Auxiliary display	Hysteresis setting
0	kPa	250ms	Standard	1
1	kgf/cm ²		Off	2
2	bar		Unit.	3
3	psi	500ms	Standard.	4
4	mmHg		Off	5
5	inchHg		Unit	6
6	--	1,000ms	Standard	7
7	-		Off	8
8	-		Unit	-
9	-	-	-	-

■ How to Install

- Panel: Use optional accessory DPA-PFKit.

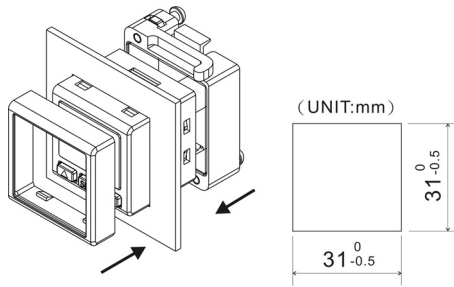

- To install the fixing frame, you have to purchase the optional accessory: DPA-FMKit.

■ Dimension

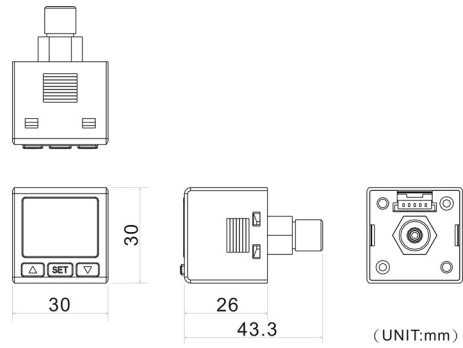

■ Internal Circuit

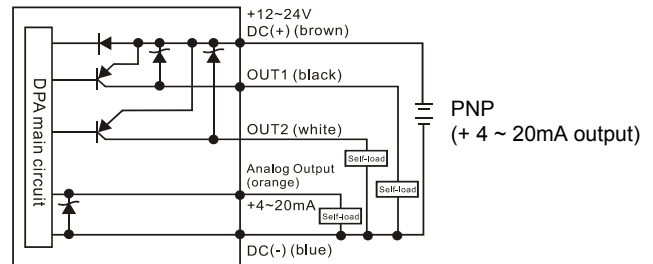
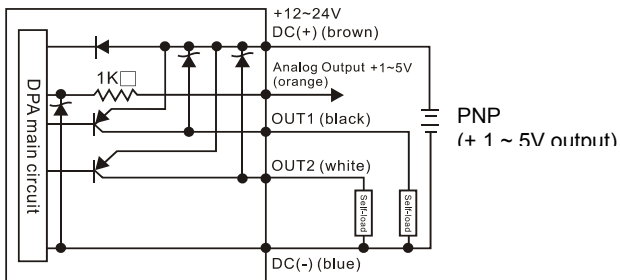
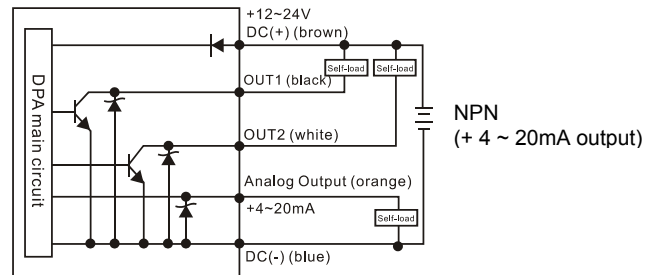
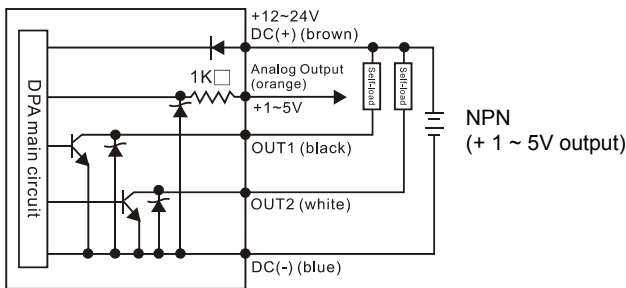

■ Terminals

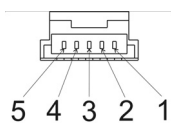

1. Positive power supply input (brown)
2. Digital output 1 signal (black)
3. Digital output 2 signal (white)
4. Analog output signal (orange)
5. Negative power supply input (blue)