

VLT® 5000/ 5000 FLUX/ 6000 HVAC/ 8000 AQUA



Operating Instructions

DeviceNet



■ Contents

Introduction to Danfoss VLT series and DeviceNet	2
Product Overview	2
Product and Environment	2
Overall Function	2
Network	2
User Profile	2
Data Communication Interface	2
Initialization of VLT frequency converter Interface	2
Network Variable Handling	3
Error Handling	3
Overall Function	3
Technical Data	5
Identity Object	5
Message Router	5
General Information	5
Network Power Supply	5
Cable Lengths	6
Cable Specifications	6
Cable Cross Section	7
Connection of the Cable Screen	8
VLT 2800 Earth Connection	8
DeviceNet Connection	8
User Interface	9
Understanding Module Configuration Switches	10
EMC Precautions	11
Setting the DeviceNet Node Address	12
Switch Settings for DeviceNet Node Addressing	12
Setting the Baud Rate	12
VLT Response Time	13
General Purpose Discrete I/O	13
I/O Assembly Instances	13
Fieldbus Profile	14
Fieldbus Profile	14
Control Word	14
Status Word	16
Control Word under VLT standard	18
Status Word under VLT standard	19
Control Word and Status Word under Instance 20/70	20
Programming	21
Quick Setup	21
Special Attention	21
Warning and Alarm Messages	26
Warning and Alarm Messages	26
Factory Settings	27

■ Product Overview**■ Product and Environment**

The DeviceNet Option Card is an interface between the DeviceNet serial communication bus and the VLT frequency converter from Danfoss. The option card will function as an integrated part of the drive.

DeviceNet is a distributed control network. The DeviceNet protocol is embedded in the controller option card and is a communication protocol conforming to the Open DeviceNet Vendor Association (ODVA) standard.

The option card allows DeviceNet compatible controllers, sensors, and network management tools to control, monitor, and supervise the VLT frequency converter. The option is designed to the DeviceNet System Protocol for Vendors as a slave device.

■ Overall Function

A DeviceNet compatible device has the ability to perform the following operations with the VLT frequency converter over the DeviceNet network:

1. Control speed references and send drive control commands.
2. Monitor the status of the drive, access alarm and warning messages, and monitor drive and motor information.
3. Upload and download drive settings, configure drives, and also perform the operations defined in 1 and 2.

Therefore, the level of control and flexibility of the VLT frequency converter over the network depends on the capabilities built into the controlling device.

The application program has the following functions:

1. Support interger parameters through the dual ported RAM.
 2. Manipulate the dual ported RAM parameters to interface with the CAN.
 3. Monitor network activity "watchdog" function to determine Master – Slave communication continuity.
-

■ Network

The VLT frequency converter will function as a slave on the DeviceNet network. All addressing and linking to nodes is done at installation time by a network manager tool. The network installer and the network management master have a significant influence on how the node functions on the network. A DeviceNet network can support up to 64 nodes.

■ User Profile

The end-user is a network manager programmer or a controller who see the DeviceNet control card as a transparent bridge to the VLT frequency converter. Control and supervision of the VLT frequency converter will still be possible through the standard parameter set.

■ Data Communication Interface

No direct data communication interface (e.g. via a serial port) other than the DeviceNet interface and the VLT frequency converter interface is considered.

■ Initialization of VLT frequency converter Interface

The VLT frequency converter interface is initialized in three phases. The first two phases are initiated and controlled by the VLT which will write commands to the option card through the dual port RAM.

Phase 1:

Is the initialization of the communication system. During this phase the option card must respond correctly to the VLT frequency converter initialization command or else the VLT will not function and display a "No Option Init" message.

Phase 2:

Is the interface watchdog function performed by the option card as the first operational action. After completion of this phase, data can be passed between the VLT frequency converter and the option card through the command channel in the dual port RAM.

Phase 3:

The VLT frequency converter will write to the Initialization Channel of the dual port RAM which will set the displacement values of the various channels (Control Channel, Status Channel, Command Channel 1, Command Channel 2, Command Channel 3, Warning Channel, and Spontan Channel), and the DeviceNet option card software will read these displacements and return a response to the VLT frequency converter notifying that the initialization was successful or an error was obtained in the process.

During operation (after initialization) the dual port RAM interface is supervised by a watch-dog in the VLT frequency converter. The VLT frequency converter will be kept "alive" by cyclic writing to a channel in the dual port RAM by the watch-dog handler of the option card.

■ Network Variable Handling

The parameter access network variable is a structure containing parameter number, data, value, and a function code containing a read or write command. The application program shall receive the data, validate the data, convert the data to the format of the VLT frequency converter, process the read or write of the parameter, then send the information back in an output network variable of the same structure. This output variable would contain the parameter number, error code information in the event of an exception, and parameter value.

■ Error Handling

The option card will stop sending a watchdog signal to the VLT frequency converter when:

1. The node has been disconnected from the network
2. A network management tool has the Option Card go Off-line
3. A hardware fault on the DeviceNet Option Card PCB prevents reliable operation

By withholding the watchdog message, the VLT frequency converter can detect a "Bus Time-out" and enter secure, pre-defined state.

For recoverable errors such as [1] and [2] the option card shall re-send the watchdog message when

the fault or condition has disappeared such as after re-connection of the node to the network.

For unrecoverable errors such as [3] the application program shall permit logging of network errors without resetting or restarting the microprocessor. This will send information to a network management tool that will allow appropriate actions to be taken. The only way to recover from a serious error is to re-initialize the VLT frequency converter DeviceNet option card by cycling power.

In case of serious VLT frequency converter fault, the DeviceNet processor shall hold the CAN chip reset, thereby disabling any communication to the node until the VLT frequency converter has been re-initialized.

■ Overall Function

DeviceNet is a low-level network that standardizes communications between industrial devices (sensors, limit switches) and high level devices (controllers). The communication network can be peer to peer or master/slave. DeviceNet uses CAN technology for Media Access Control and Physical Signaling and it supports up to 64 nodes. DeviceNet also defines device profiles for devices belonging to specific classes. For other devices, a custom class must be defined in order to make it DeviceNet compatible. This further enhances the interchangeability and interoperability of the network. Each node on the network has its own unique media access control identifier (MAC ID) to distinguish it on the network. The MAC ID is stored in the header of the message which is split into four different message groups. However, DeviceNet only makes use of three message groups keeping the fourth one for future use. If two nodes attempt to get control of the network bus simultaneously, the CAN protocol resolves the issue by arbitration. A dominant bit (0) will win arbitration over a recessive bit (1).

For the VLT frequency converter, the option card will be slave node on the DeviceNet network. The option card will be a message server that will request and set parameters in the VLT via a dual ported RAM interface. The option card has an embedded CAN controller that will screen all network messages with a Mask and Match register. This feature allows the option card to filter out any unwanted messages from the network. The option card will receive group 2 and group 3 messages. Group 2 messages allows the option card to use the predefined Master/Slave connection set which identifies a use for all group 2 message identifiers. The ability to

receive Group 3 messages allows the option card to also be an Unconnected Explicit Message Manager (UCMM) with the UCMM request and response message identifier. Explicit message connections are unconditionally point-to-point. Point-to-point connections exist between two devices only.

■ Technical Data**■ Identity Object**

This object is used to provide identification and general information about the device. This object is required by all DeviceNet products.

This object requires no class attributes. Its instance attributes are the following:

Vendor	97
Device Type	2
Product Code	Depends of the Drive
Revision - Major, Minor	Depends of option
Status	
Serial Number	
Product Name	VLT 5000

■ Network Power Supply

The DeviceNet option is an optically isolated node, where transceiver power is provided by the network. External network power supply requirements are:

- 11 - 25 VDC
 - 70 mA draw per VLT 5000 DeviceNet node
-

■ Message Router

The Message Router object provides a messaging connection point through which a Client may address a service to any object class or instance residing in the physical device.

This object requires no class attributes. Its instance attributes are the following:

1. Object List - Number of Classes
-

■ General Information

Parameter 502 = "BUS".

Otherwise terminals 12 and 27 of the control card must be connected, before motor start. In parameters 502-508 it is possible to define how to gate the control commands from the DeviceNet with the equivalent control commands of the digital inputs.

**VLT® 5000/ 5000 FLUX/ 6000 HVAC/
8000 AQUA DeviceNet**

■ **Cable Lengths**

Baud Rate	Max. total cable length [m]	Drop Length	
		Maximum	Cumulative
125k baud	500 meters (1640 ft.)	6 meters (20 ft.) for one drop	156 meters (512 ft.)
250k baud	250 meters (820 ft.)		78 meters (256 ft.)
500k baud	100 meters (328 ft.)		39 meters (128 ft.)

■ **Cable Specifications**

Physical Characteristics	Specification
Two shielded pairs	Common axis with drain wire in center
Overall braid shield	65% coverage 36 AWG Cu braid. (individually tinned)
Drain wire	# 18 (19 x 30 AWG) Copper (individually tinned)
Outside diameter	0.475 ± 0.015 inches (round), roundness - radius delta to be within 15% of 0.5 O.D.*
Jacket insulation *	0.040 inches minimum
Jacket marking *	Vendor Name & Part # 1 Pr 18 and 1 Pr 15 AWG shielded, additional markings are acceptable
Electrical Characteristics	Specification
DRC (braid + tape + drain)	1.75 Ohms/1000 ft. (nom. @ 20°C)
Applicable Environmental Characteristics	Specification
Agency Certifications (U.S. and Canada)	NEC (UL) type, CL2/CL3 (min.)
Bend radius - installation / fixed	20 x diameter / 7 x diameter
Operating ambient temperature	-20° to + 60°C @ 8 amps; de-rate current linearly to zero @ 80°C
Storage temperature	-40° to + 85°C
Pull tension	190 lbs max

* Other types of jacket insulation are allowable provided that internal construction and electrical characteristics adhere to this specification.

■ Cable Cross Section

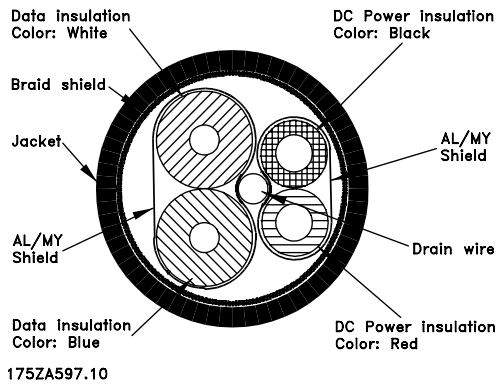

Technical
Data

■ Connection of the Cable Screen

The screen of the DeviceNet cable must always be connected to ground at both ends, that means the screen must be connected to ground in all stations connected to the DeviceNet network. It is very important to have a low impedance ground connection of the screen, also at high frequencies. This can be obtained by connecting the surface of the screen to ground, for example by means of a cable clamp or a conductive cable gland. VLT frequency converter Series are provided with different clamps and brackets to enable a proper ground connection of the DeviceNet cable screen. The screen connection is shown in the drawing.

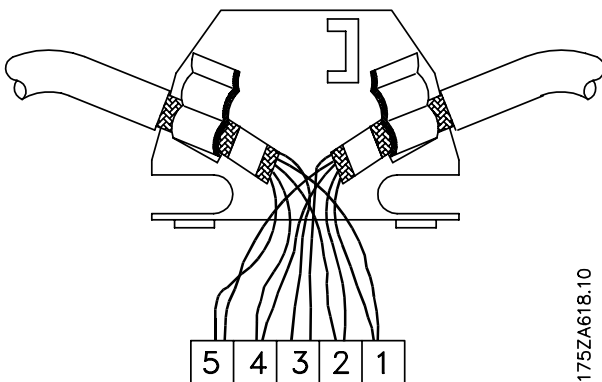

175ZA618.10



NB!:

Wires should not be installed while the network is active. This will prevent problems such as shorting the network supply or disrupting communications.

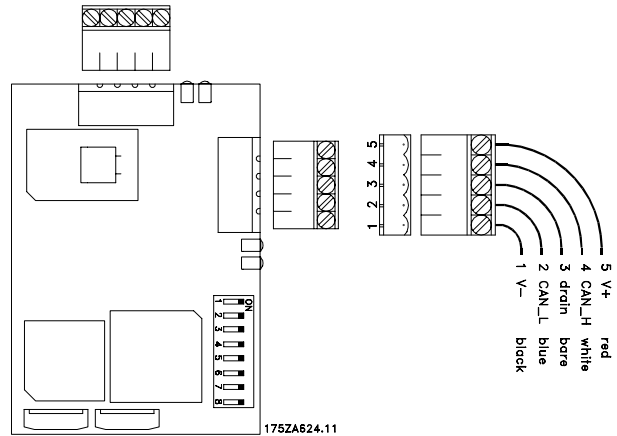

■ VLT 2800 Earth Connection

It is important that all stations connected to the DeviceNet network are connected to the same earth potential. The earth connection must have a low HF (high frequency) impedance. This can be achieved by connecting a large surface area of the cabinet to ground, for example by mounting the VLT frequency converter on a conductive rear plate. Especially when having long distances between the stations in a DeviceNet network it can be necessary to use additional potential equalizing cables, connecting the individual stations to the same earth potential.

■ DeviceNet Connection

It is essential that the bus line be terminated properly. A mismatch of impedance may result in reflections on the line that will corrupt data transmission.

The DeviceNet Option Card is provided with a pluggable screw connector.

By using a pluggable screw connector as a splice between two trunk lines, removal of devices will not sever the network. Strain relief, if required, must be provided by the developer. In current installations of this type of connector, the strain relief is attached to the product.

■ **User Interface**

The DeviceNet option card contains two bi-color (green/red) LED's for each connector hookup port, to indicate the state of the device and network, respectively.

For the device status LED:

1. when the LED is off, the device is off
2. when the LED is green, the device is operational
3. When the LED is flashing green, the device is in standby
4. when the LED is flashing red, the device detects a minor fault
5. when the LED is red, the device detects an unrecoverable fault
6. when the LED is flashing red/green, the device is self testing

For the network status LED:

1. when the LED is off, the network is non-powered/not online
2. when the LED is flashing green, the network is online but not connected
3. when the LED is green, the network is online and connected
4. when the LED is flashing red, the network has a connection time-out
5. when the LED is red, the network has a critical link failure. No further direct user interface is considered

No further direct user interface is considered.

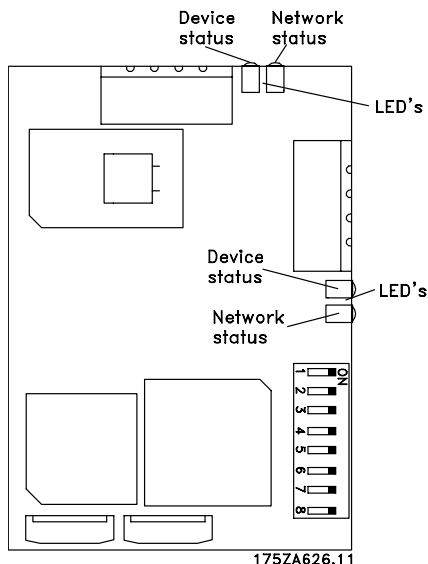

Technical Data

■ **Understanding Module Configuration Switches**

The DeviceNet Communication module's DIP switch settings determine:

- DeviceNet node address
- DeviceNet baud rate

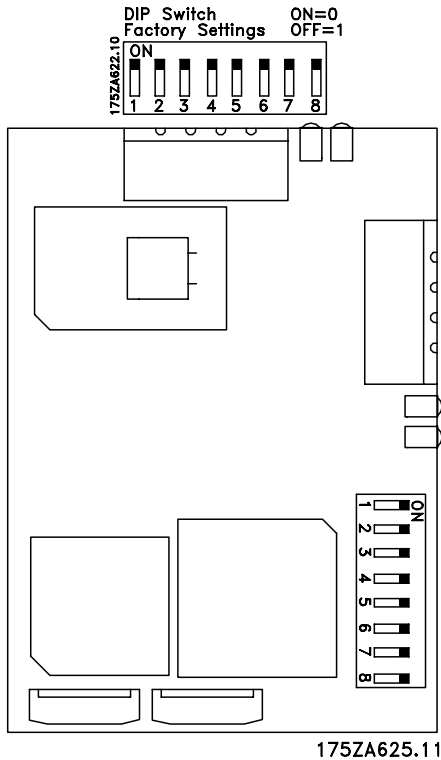

When you make changes to the switch settings, use a pointed instrument such as a ball point pen. DO NOT use a pencil because damage may occur



Unpredictable operation may occur if you fail to check connections and DIP switch settings for compatibility with your application. Unpredictable operation may result in death, personal injury, and equipment damage.



Hazard of injury or equipment damage may occur due to unintended or incorrect machine motion. When a system is configured for the first time, the motor must be disconnected from the machine or process during initial system testing.



NB!:

When setting the Communication Module's addressing Dip Switches, you must ensure that each serial device on the network has a unique address. Also, all devices connected to the network must be set at the same baud rate.

VLT® 5000/ 5000 FLUX/ 6000 HVAC/ 8000 AQUA DeviceNet

■ EMC Precautions

EMC precautions The following EMC precautions are recommended to obtain interference free operation of the DeviceNet network. Additional information on EMC can be found in the VLT 5000 Series Instruction Manual.



NB!

Relevant national and local regulations, for example regarding protective earth connection, must be observed

coupling of high frequency noise from one cable to the other. Normally a distance of 8 inches (200 mm) is sufficient, but it is generally recommended to keep the greatest possible distance between the cables, especially where cables are running in parallel over long distances.

If the DeviceNet cable has to cross a motor and brake resistor cable they must cross each other at an angle of 90°.

The DeviceNet communication cable must be kept away from motor and brake resistor cables to avoid

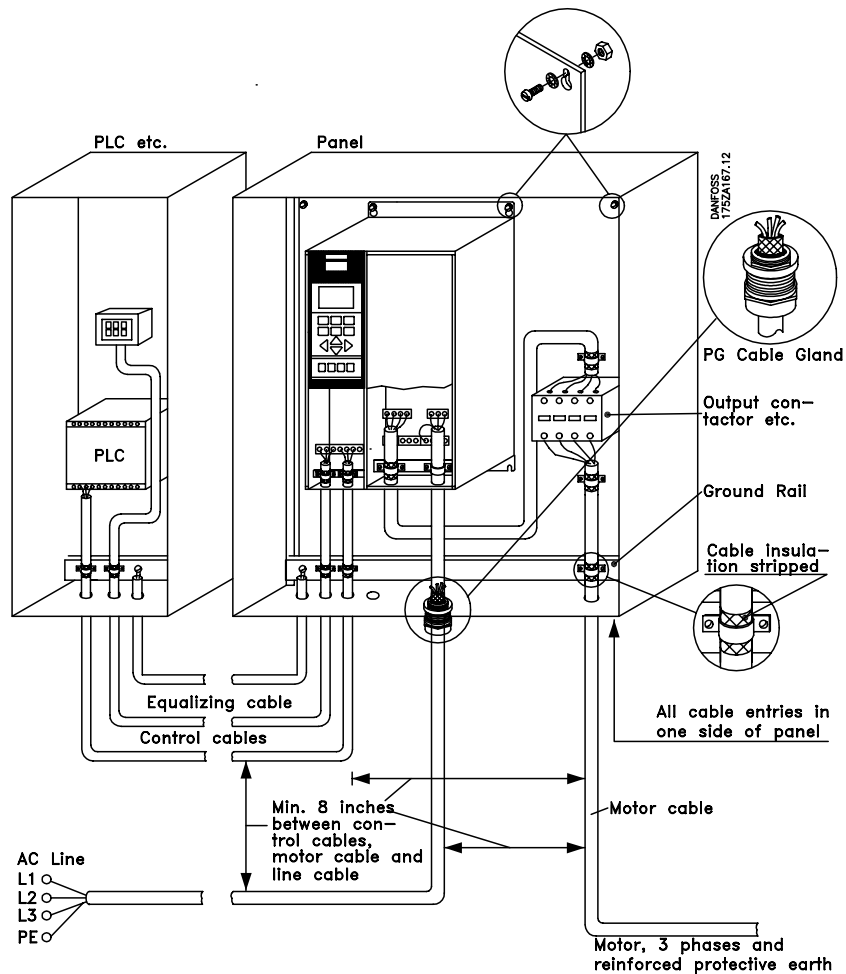

Technical
Data

VLT® 5000/ 5000 FLUX/ 6000 HVAC/ 8000 AQUA DeviceNet

■ Setting the DeviceNet Node Address

Dip switches 6 through 1 set the module's node address using binary addressing.

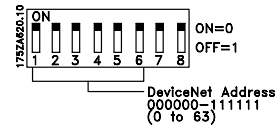

■ Switch Settings for DeviceNet Node Addressing

Follow these steps to set the DeviceNet node address:

1. Refer to the table below for the switch settings of a specific address.

2. Using your finger or a pointed object, slide switches 1 through 6 to the appropriate ON/OFF positions.

DeviceNet Address	Switch Settings 1⇒6	DeviceNet Address	Switch Settings 1⇒6	DeviceNet Address	Switch Settings 1⇒6	DeviceNet Address	Switch Settings 1⇒6
0	000000	16	000010	32	000001	48	000011
1	100000	17	100010	33	100001	49	100011
2	010000	18	010010	34	010001	50	010011
3	110000	19	110010	35	110001	51	110011
4	001000	20	001010	36	001001	52	001011
5	101000	21	101010	37	101001	53	101011
6	011000	22	011010	38	011001	54	011011
7	111000	23	111010	39	111001	55	111011
8	000100	24	000110	40	000101	56	000111
9	100100	25	100110	41	100101	57	100111
10	010100	26	010110	42	010101	58	010111
11	110100	27	110110	43	110101	59	110111
12	001100	28	001110	44	001101	60	001111
13	101100	29	101110	45	101101	61	101111
14	011100	30	011110	46	011101	62	011111
15	111100	31	111110	47	111101	63	111111

■ Setting the Baud Rate

Dip switches 7 and 8 set the baud rate at which the Communication Module communicates on the network. The factory default setting is 125K BPS.

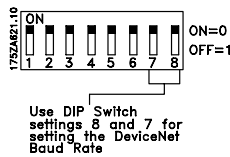

Switch Settings for DeviceNet Module Baud Rate:

Baud Rate	Switch Setting 7	Switch Setting 8
125 kBPS	0	0
250 kBPS	1	0
500 kBPS	0	1
125 kBPS	1	1

■ VLT Response Time

The update time via the DeviceNet connection can be divided into two parts:

1. The communication time, which is the time it takes to transmit data from the master to the slave (VLT with DeviceNet option).
2. The internal update time, which is the time it takes to transmit data between the VLT 5000 control card and the DeviceNet option card.

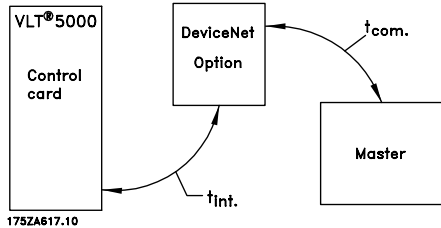

Communication time (t_{com}) depends on the actual transmission speed (baudrate) and the type of master

in use. More data or lower transmission speed will increase the communication time.

The internal update time (t_{int}) depends on the type of data in question as there are different channels for the data transfer where time critical data e.g. control word has highest priority. The internal update time for the different types of data are stated below.

Data	Update time, t_{int}
Control word/Main reference (part of PPO)	2 msec
Status word/Actual output frequency (part of PPO)	2 msec
Parameter read via PCD-part of PPO	2 msec
Parameter write via PCD-part of PPO	83 msec
Parameter read/write via explicite message	22 msec

■ General Purpose Discrete I/O

The General Purpose Discrete I/O device I/O assemblies consist of:

- five predefined input assemblies with single status bits
- one product-specific input assembly with a single status bit

- five predefined input assemblies with multiple status bits
- one product-specific input assembly with multiple status bits
- five predefined output assemblies
- one product-specific output assembly

■ I/O Assembly Instances

The I/O Assembly Instance definitions in this section define the format of the "data" attribute (attribute 3) for I/O Assembly Instances. I/O Assemblies support a hierarchy of motor control devices. The device hierarchy includes motor starters, soft starters, AC and DC drives, and servo drives. Assembly Instances are numbered within the hierarchy so that each device type is assigned a range of Assembly Instance

numbers, with higher functionality devices supporting higher instance numbers. Devices in the hierarchy can choose to support instance numbers that are lower than theirs in the hierarchy. For example an AC drive may choose to support some I/O Assemblies in the starter profile to make it easier to interchange starters and drives within the system.

Parameter	Decimal	WRITE				Decimal	READ						
		CTW	SPEED RPM	REF			STW	AC REF	MAV				
904													
PP03	20	CTW	SPEED RPM			70	STW	AC REF					
PP01	100	CTW	REF			150	STW	MAV					
PP02	101	CTW	REF	915.1	915.2	151	STW	MAV	916.1	916.2			
PP04	102			915.1	915.2	915.3	915.4	916.1	916.2	916.3	916.4		

■ **Fieldbus Profile**

■ **Control Word**

Control Word as per Profidrive standard (parameter 512 = Fieldbus Profile). The control word is used for transmitting commands from a master (e.g. a PC) to a slave (VLT frequency converter).

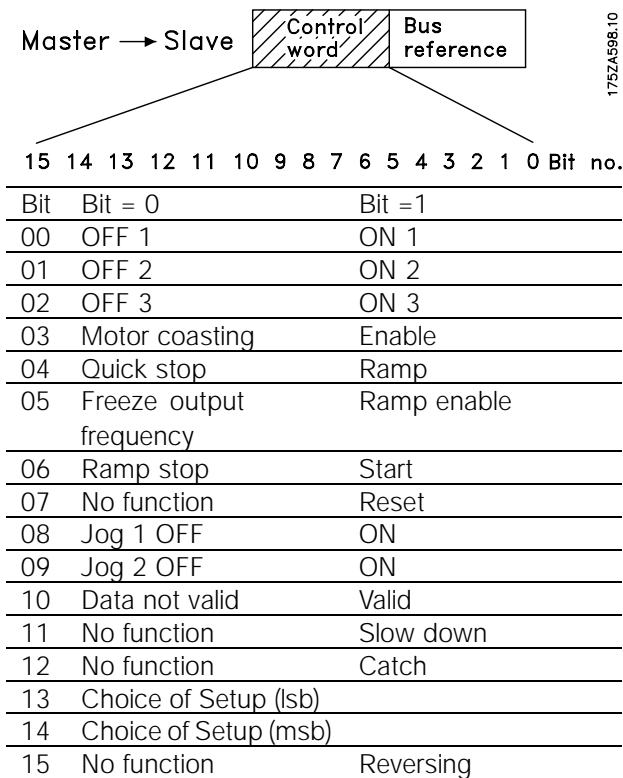

175ZA598,10

selected in parameter 323 or 326. Bit 02 = "1" means that the adjustable frequency drive is able to start, provided the other conditions for starting are fulfilled.

Bit 03, Coasting/enable:

Coasting stop. Bit 03 = "0" leads to a stop. Bit 03 = "1" means that the adjustable frequency drive is able to stop, provided the other conditions for starting are fulfilled. Note: in parameter 502 the choice is made as to how bit 03 is to be combined (gated) with the corresponding function in the digital inputs.

Bit 04, Quick-stop/ramp:

Quick-stop which uses the ramp time in parameter 212. Bit 04 = "0" leads to a quick-stop. Bit 04 = "1" means that the adjustable frequency drive is able to start, provided the other conditions for starting are fulfilled. Note: In parameter 503 the choice is made as to how bit 04 is to be combined (gated) with the corresponding function on the digital inputs.

Bit 05, Freeze output frequency/ramp enable:

Bit 05 = "0" means that the given output frequency is maintained even if the reference is changed. Bit 05 = "1" means that the adjustable frequency drive is again able to regulate, and the given reference is followed.

Bit 06, Ramp stop/start:

An ordinary ramp stop that uses the ramp time in parameters 207/208 or 209/210; in addition, output relay 01 or 04 will be activated when the output frequency is) Hz, provided Relay 123 has been selected in parameter 323 or 326. Bit 06 = "0" leads to a stop. Bit 06 = "1" means the adjustable frequency drive is able to start, provided the other conditions for starting are fulfilled. In parameter 505 the choice is made as to how bit 06 is to be combined (gated) with the corresponding function on the digital inputs.

Bit 07, No function/reset:

Reset of trip. Bit 07 = "0" means that there is no reset. Bit 07 = "1" means that a trip is reset.

Bit 00, OFF1/ON1:

An ordinary ramp stop which uses the ramp time in parameters 207/208 or 209/210. Bit 00 = "0" leads to a stop and leads to output relay 01 or 04 being activated, the output frequency is 0 Hz, provided Relay 123 has been selected in parameter 323 or 326. Bit 00 = "1" means that the adjustable frequency drive will be able to start if the other conditions for starting have been fulfilled.

Bit 01, OFF2/ON2:

Coasting stop. Bit 01 = "0" leads to a coasting stop and leads to output relay 01 or 04 being activated, when the output frequency is 0 Hz, provided Relay 123 has been selected in parameter 323 or 326. Bit 01 = "1" means that the adjustable frequency drive is able to start provided the other conditions for starting are fulfilled.

Bit 02, OFF3/ON3:

Quick-stop, which uses the ramp time set in parameter 212. Bit 02 = "0" leads to a quick stop and leads to output relay 01 or 04 being activated, when the output frequency is 0 Hz, provided Relay 123 has been

Bit 08, Jog 1 OFF/ON:

Activation of pre-programmed speed in parameter 509 (Bus Jog 1). JOG 1 is only possible when Bit 04 = "0" and bit 00-03 = "1".



NB!:

Parameter 507 is used for choosing how bits 13/14 are to be combined (gated) with the corresponding function on the digital inputs.

Bit 09, Jog 2 OFF/ON:

Activation of pre-programmed speed in parameter 510 (Bus Jog 2). JOG 2 is only possible when Bit 04 = "0" and bits 00-03 = "1". If both JOG 1 and JOG 2 are activated (bits 08 and 09 = "1"), JOG 1 has the higher priority, which means that the speed programmed in parameter 509 will be used.

Bit 10, Data not valid/valid:

Used for telling VLT 5000 whether the control word is to be used or ignored. Bit 10 = "0" means that the control word is ignored. Bit 10 = "1" means that the control word is used. This function is relevant because the control word is always contained in the telegram, regardless of the type of telegram used, i.e. it is possible to disconnect the control word if it is not to be used in connection with updating or reading of parameters.

Bit 11, No function/slow down:

Used for reducing the speed reference by the value in parameter 219. Bit 11 = "0" means that there is no change of the reference. Bit 11 = "1" means that the reference is reduced.

Bit 12, No function/catch-up:

Used for increasing the speed reference by the value of parameter 219. Bit 12 = "0" means that the reference is increased. If both slow down and catch-up are activated (bits 11 and 12 = "1"), slow down has the higher priority, i.e. the speed reference is reduced.

Bits 13/14, Choice of Setup:

Bits 13 and 14 are used for choosing among the four menu Setups in accordance with:

Setup	Bit 14	Bit 13
1	0	0
2	0	1
3	1	0
4	1	1

This function is only possible if Multi-Setups have been selected in parameter 004.

Bit 15, No function/reversing:

Reversing of the direction of rotation of the motor. Bit 15 = "0" leads to no reversing, bit 15 = "1" leads to reversing.

Note that as a point of departure reversing has been selected as Digital in parameter 506. Bit 15 only leads to reversing if bus, logical or or logical and has been selected (logical and, however, only together with terminal 19).



NB!:

Unless otherwise mentioned, the control word bit is combined (gated) with the corresponding function on the digital inputs as a logical "or" function.

■ **Status Word**

Status Word (according to Profidrive standard (parameter 512 = Fieldbus Profile). The status word is used for informing the master (e.g. a PC) of the condition of a slave (VLT frequency converter).

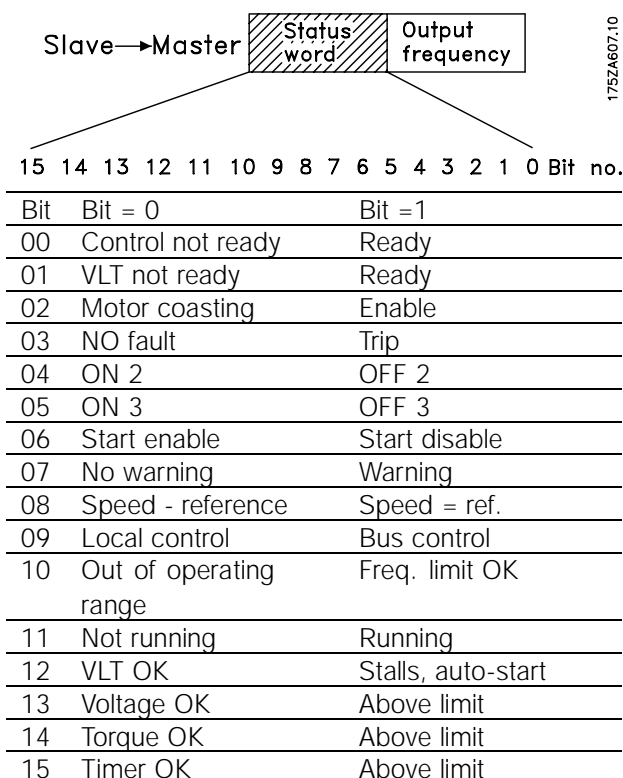

Bit 00, Control not ready/ready:

Bit 00 = "0" means that bit 00, 01 or 02 of the control word is "0" (OFF1, OFF2 or OFF3), or that the adjustable frequency drive has tripped. Bit 00 = "1" means that the adjustable frequency drive is ready, but that there

is not necessarily any supply to the power component (in case of external 24 V supply to the controls).

Bit 01, VLT not ready/ready:

Same meaning as bit 00; however, there is also a supply to the mains component, and the adjustable frequency drive is ready to run when it receives the necessary start signals.

Bit 02, Coasting/enable:

Bit 02 = "0" means that the control word bit 00, 02 or 03 is "0" (OFF1, OFF2, OFF3 or Coasting), or the VLT 5000 Series unit has tripped. Bit 02 = "1" means that the control word bits 00, 01, 02 or 03 are "1" and that VLT 5000 Series has not tripped.

Bit 03, No fault/trip:

Bit 03 = "0" means that VLT 5000 Series is not in a fault condition. Bit 03 = "1" means that VLT 5000 Series has tripped and needs a reset signal in order to run.

Bit 04, ON2/OFF2:

Bit 04 = "0" means that control word bit 01 = "1". Bit 04 = "1" means that control word bit 01 = "0".

Bit 05, ON3/OFF3:

Bit 05 = "0" means that control word bit 02 = "1". Bit 05 = "1" means that control word bit 02 = "0".

Bit 06, Start enable/start disable:

Bit 06 is always "0" if Danfoss has been selected in parameter 512. If Profidrive has been selected in parameter 512, bit 06 will be "1" after reset of a trip, after activation of OFF2 or OFF3 and after connection of mains voltage. Start disable is reset, setting control word bit 00 to "0" and bits 01, 02 and 10 to "1".

Bit 07, No warning/warning:

Bit 07 = "0" means that there is no unusual situation. Bit 07 = "1" means that an abnormal condition has arisen for the VLT 5000 Series. All warnings described in the VLT 5000 instruction manual will set bit 07 to "1".

Bit 08, Speed ref/speed. = ref.:

Bit 08 = "0" means that the actual motor speed is different from the speed reference set. This can be the case while the speed is ramped up/down during start/stop. Bit 08 = "1" means that the present motor speed equals the speed reference set.

Bit 09, Local control/Bus control:

Bit 09 = "0" means that VLT 5000 Series has been stopped by means of the stop key on the control panel, or that Local operation has been selected in parameter 002. Bit 09 = "1" means that it is possible to control the adjustable frequency drive via the serial port.

Bit 10, Out of operating range/Freq. limit OK:

Bit 10 = "0" means that the output frequency is out of the range set in parameter 225 (Warning: Low frequency) and parameter 226 (Warning: High frequency). Bit 10 = "1" means that the output frequency lies within the mentioned range.

Bit 11, Does not run/runs:

Bit 11 = "0" means that the motor is not running. Bit 11 = "1" means that VLT 5000 Series has a start signal of that the output frequency is greater than 0 Hz.

Bit 12, VLT OK/stalling, autostart:

Bit 12 = "0" means that there is no temporary overtemperature on the inverter. Bit 12 = "1" means that the inverter has stopped because of overtemperature, but that the unit has not tripped and will continue, once the overtemperature stops.

Bit 13, Voltage OK/above limit:

Bit 13 = "0" means that the voltage limits of VLT 5000 Series have not been exceeded. Bit 13 = "1" means that the DC voltage of the VLT 5000 Series intermediate circuit is too low or too high.

Bit 14, Torque OK/above limit:

Bit 14 = "0" means that the motor current is lower than the torque limit selected in parameter 221. Bit 14 = "1" means that the torque limit in parameter 221 has been exceeded.

Bit 15, Timers OK/above limit:

Bit 15 = "0" means that the timers for the motor thermal protection and VLT thermal protection, respectively, have not exceeded 100%. Bit 15 = "1" means that one of the timers has exceeded 100%.

Control Word under VLT standard

(parameter 512 = FC Profile). The control word is used for sending commands from a master (e.g. a PC) to a slave (VLT frequency converter).

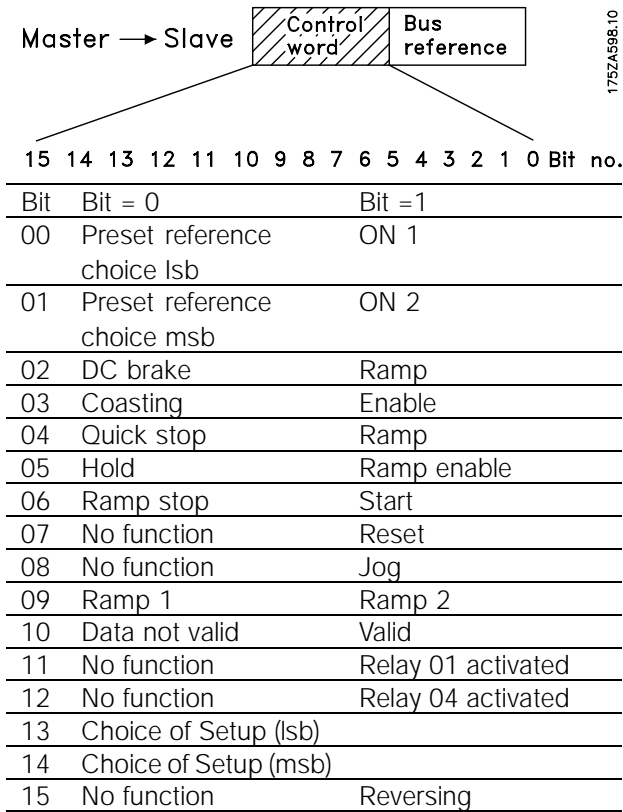

175ZA598.10

Bit 00/01: Bits 00 and 01 are used for choosing among the four pre-programmed references (parameters 215-218) in accordance with the following table:

Preset ref.	Parameter	Bit 01	Bit 00
1	215	0	0
2	216	0	1
3	217	1	0
4	218	1	1



NB!:

Parameter 508 is where to choose the way bits 1/12 are to be combined (gated) with the corresponding function on the digital inputs.

Bit 02, DC Brake:

Bit 02 = "0" leads to DC braking and stop. Braking current and duration are set in parameters 125 and 126. Bit 02 = "1" leads to ramping.

Bit 08, Activation of Jog speed in parameter 213:

Bit 08 = "0": Jog speed not activated. Bit 08 = "1" means that the motor is running at Jog speed.

Bit 09, Choice of ramp 1/2:

Bit 09 = "0" means that ramp 1 is active (parameters 207/208). Bit 09 = "1" means that ramp 2 (parameters 209/210) is active.

Bit 11, Relay 01:

Bit 11 = "0": Relay 01 not activated. Bit 11 = 1: Relay 01 activated, provided Control word bit has been chosen in parameter 323.

Bit 12, Relay 04:

Bit 12 = "0": Relay 04 has not been activated. Bit 12 = "1": Relay 04 has been activated, provided Control word bit has been chosen in parameter 326. See the description of other bits under control word for Profidrive standard.



NB!:

Unless otherwise mentioned, the control word bit is combined (gated) with the corresponding function on the digital inputs as a logical "or" function.

Status Word under VLT standard

(parameter 512 = FC Profile). The status word is used for informing the master (e.g. a PC) about the condition of the slave (VLT frequency converter).

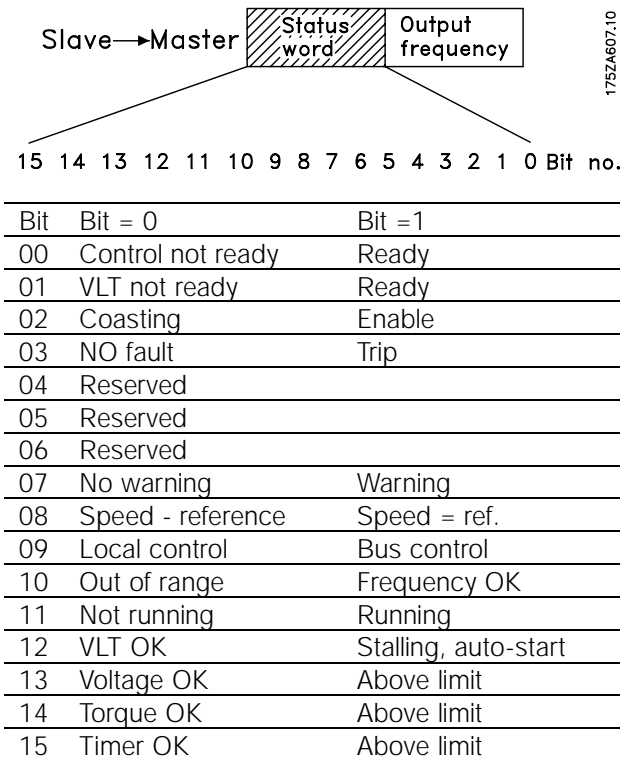

Bit 00, Control not ready/ready:

Bit 00 = "0" means that the adjustable frequency drive has tripped. Bit 00 = "1" means that the adjustable frequency drive controls are ready, but the power component is not necessarily receiving any power supply (in case of external 24 V supply to controls).

Bit 02, Coasting/enable:

Bit 02 = "0" means that the control word bit 03 is "0" (Coasting) or that VLT 5000 Series has tripped. Bit 02 = "1" means that control word bit 03 is "1" and that VLT 5000 Series has not tripped. See the description of other bits under status word for the Profdrive standard.

Bus reference value:

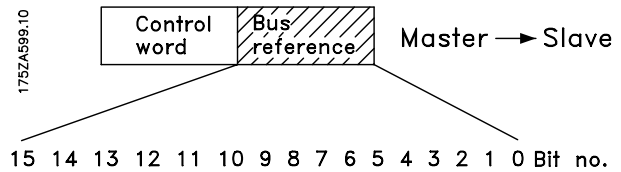

The frequency reference value is transmitted to the adjustable frequency drive in the form of a 16-bit word. The value is transmitted as a whole number (0-32767). 16384 (4000 Hex) corresponds to 100%. (Negative figures are formatted by means of 2's complement.) The bus reference has the following format:
Parameter 203 = "0"

$$\text{"ref}_{\text{MIN}} - \text{ref}_{\text{MAX}}"$$

$$0-16384 \text{ (4000 Hex)} \sim 0-100\% \sim \text{ref}_{\text{MIN}} - \text{ref}_{\text{MAX}}$$

Parameter 203 = "1"

$$- \text{ref}_{\text{MIN}} - + \text{ref}_{\text{MAX}}$$

$$- 16384 \text{ (...Hex)} - + 16384 \text{ (4000 Hex)} \sim$$

$$- 1000 - + 100\% \sim - \text{ref}_{\text{MAX}} - + \text{ref}_{\text{MAX}}$$

Actual output frequency

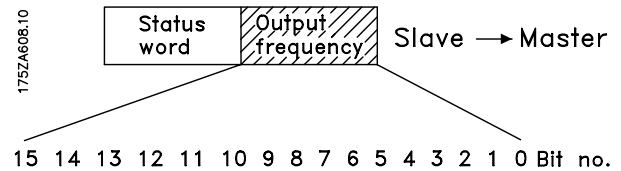

The value of the actual output frequency of the adjustable frequency drive is transmitted in the form of a 16-bit word. The value is transmitted as a whole number (0-32767). 16384 (4000 Hex) corresponds to 100%. (Negative figures are formed by means of 2's complement).

■ Control Word and Status Word under Instance 20/70

Set parameter 904 *PPO type 1* to select Instance 20/70 [12].

The control word in Instance 20 is defined as following:

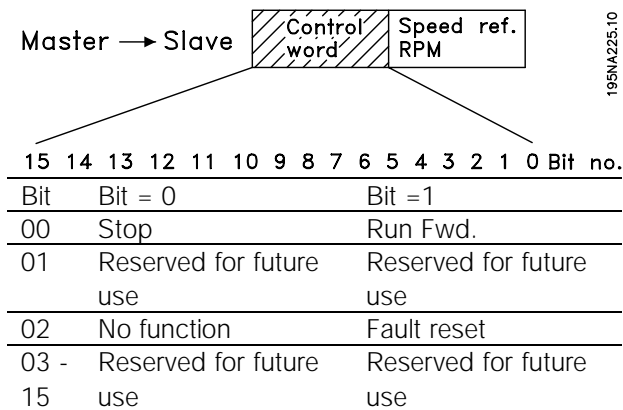

Bit 0, Run Fwd:

Bit 0 = "0" means that the VLT frequency converter has a stop command.

Bit 0 = "1" leads to a start command and the VLT frequency converter will start to run the motor.

Bit 2, Fault Reset

Bit 0 = "0" means that there is no reset of a trip.

Bit 0 = "1" means that a trip is reset.

Regarding the Speed reference, see section *Bus speed reference value*, under Instance 20/70 and 21/71.

The status word in Instance 70 is defined as following:

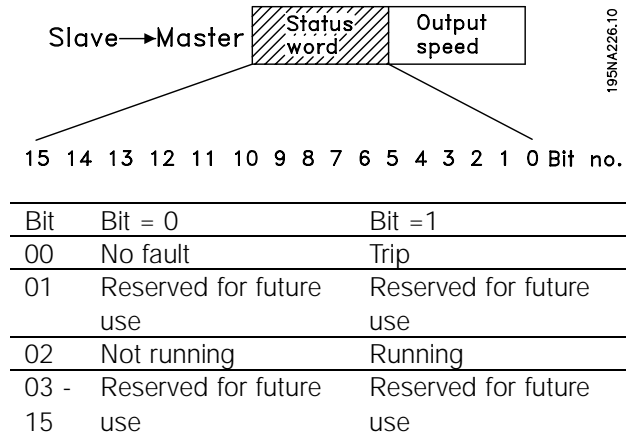

Bit 0, Fault:

Bit 0 = "0" means that there is no fault on the VLT frequency converter.

Bit 0 = "1" means that there is a fault on the VLT frequency converter.

Bit 2, Running

Bit 0 = "0" means that there is no active start command.

Bit 0 = "1" means that there is an active start command.

■ Quick Setup

For how to program the ordinary VLT parameters refer to the VLT 5000 Series Instruction Manual. Communication is established by setting the following parameters:

Parameter 904:

Select the PPO type to be applied.

Parameter 918:

Readout of the actual address of the DeviceNet option via dip switch.

Parameter 801:

Readout the transmission speed in bit/sec. The default setting is 125 kbaud, which means the VLT automatically detects the transmission speed of the connected bus. If you set a fixed value it must be the same as that selected in the master.

■ Special Attention

Special attention must be given to the following parameters described in the VLT 5000 Series Instruction Manual:

- 002:

If operation site = Local, then control via DeviceNet is not possible.

- 502-508:

Selection of how to gate DeviceNet control commands with control commands on the digital inputs of the control card.

- 512:

Selects DeviceNet profile.

- 515-538:

Data read out parameters that can be used to read various actual data from the VLT, as for example actual status on the analog and digital inputs of the control card thus using these as inputs to the master.

801 Baud rate selection

(BAUD RATE SELECT)

Value:

125 kBaud (125 KBAUD)	[20]
250 kBaud (250 KBAUD)	[21]
500 kBaud (500 KBAUD)	[22]

Function:

This parameter displays the actual Baud rate of the devicenet option.

803 Time after bus error (BUS TIME OUT)

Value:

1 - 99 sec ★ 1 sec

804 Response after bus error (TIME OUT FUNCT.)

Value:

★Off (OFF)	[0]
Freeze output frequency (FREEZE OUTPUT)	[1]
Stop with auto restart (STOP)	[2]
Output frequency = JOG frequency (JOGGING)	[3]
Output frequency = Max. freq. (MAX SPEED)	[4]
Stop with trip (STOP AND TRIP)	[5]
Control without DeviceNet (NO DEVICENET CONTROL)	[6]
Select set up 4 (SELECT SETUP 4)	[7]

Function:

The time out counter is triggered at the first reception of a valid control word i.e. bit 10 = ok.

1. CTW is not updated within the specified time
2. Parameter 805 = "bit 10 = 0 ⇒ time out" and bit 10 = "0"

The VLT remains in the timeout state until one of the following four conditions occurs:

1. Valid control word (Bit 10 = ok) is received and reset (Bus, terminals or local control panel) is activated (reset is only necessary when the time out function Stop w/trip is selected) ⇒ control via DeviceNet is resumed with the actual control word
2. Parameter 002 = Local ⇒ Local control via local control panel is enabled.
3. Parameter 928 = Disabled ⇒ Normal control via terminals and RS485 is enabled.
4. Parameter 804 = Off ⇒ control via DeviceNet is resumed, with the control word used last being taken.



NB!:

The time out counter is reset and needs to be triggered by a valid control word before a new timeout can be activated

Description of choice:

- Save output frequency: Save ('freeze') the output frequency until communication resumes.
- Stop with auto restart: Stop with automatic restart on resumption of communication.
- Output frequency = Fixed speed frequency: Motor runs with fixed speed frequency until resumption of communication.
- Output frequency = max. frequency: Motor runs with the maximum frequency until resumption of communication.
- Stop with trip: Motor has stopped, a reset is necessary for a restart, see explanation above.
- Control without DeviceNet: Control via DeviceNet is inactive; control is possible via the terminals and/or the RS 485 standard interface until communication resumes.
- Selection parameter setup 4: Parameter setup 4 is selected in parameter 004; the settings of parameter setup 4 are used. Parameter 004 is not reset to the original value upon resumption of communication.

**805 Function control word bit 10
(BIT 10 FUNCTION)**
Value:

- Without function (NO FUNCTION) [0]
- ★Bit 10 = 1 ⇒ CTW active (BIT 10 = 1 ⇒ CTW ACTIVE¹)
- Bit 10 = 0 ⇒ CTW active (BIT 10 = 0 ⇒ CTW ACTIVE²)
- Bit 10 = 0 ⇒ Timeout (BIT 10 = 0 ⇒ TIMEOUT) [3]

Function:

This is sometimes necessary since some masters set all bits to 0 in different error situations. In these cases it makes sense to change the function of bit 10 so that the command to stop (coasting) goes to the VLT if all bits are 0.

Description of choice:

- Bit 10 = 1 ⇒ CTW active: If bit 10 = 0, the control word and speed reference value are ignored.
- Bit 10 = 0 ⇒ CTW active: If bit 10 = 1, the control word and speed reference value are ignored. If all bits of the control word are 0, the VLT will switch to coasting in response hereto.
- Bit 10 = 0 ⇒ Timeout: If bit 10 = 0, the timeout function selected in parameter 804 is activated.
- Without function: Bit 10 is ignored, i.e. the control word and speed reference value are always valid.

★ = factory setting. () = display text [] = value for use in communication via serial communication port

904 PPO selection

(PPO TYPE SELECT)

Value:

★PPO type 1 (PPO TYPE 1)	[900]
PPO type 2 (PPO TYPE 2)	[901]
PPO type 3 (PPO TYPE 3)	[902]
PPO type 4 (PPO TYPE 4)	[903]

Function:

The choice of PPO type has to match the input and output data of the master.

Description of choice:

900 = PPO type 1 (100/150):

This PPO type has a 16 bit control word and a 16 bit reference to controlling the VLT. The status word and the actual speed value will also be returned as 16 bit value. See *Fieldbus profile*.

901 = PPO type 2 (101/151):

The same structure as in PPO type 1, but with 2 additional free selectable process data.

902 = PPO type 3 (20/70):

This profile fulfill the Instance 20/70 profile. See *Control word under Instance 20/70*.

903 = PPO type 4 (102/152):

4 free selectable process data that can be chosen in parameter 915/916 *PCD configuration*.

915 PCD write configuration

(PCD CONFIG WRITE)

Value:

Sub index 1 (PCD 1)	[Parameter number]
Sub index 2 (PCD 2)	[Parameter number]

Function:

Different parameters can be assigned to PCD 1-2 if instance 101/151 is selected in parameter 904 *PPO Selection*. The values in PCD 1-2 will be written to the selected parameters in the form of data values.

Description of choice:

The sequence of the subindexes corresponds to the sequence of the PCD in the PPO, i.e. subindex 1 = PCD 1, subindex 2 = PCD 2 etc. Each subindex may contain the number of any VLT parameter.

Note that subindex 3 - 8 are having no function.

916 PCD read configuration

(PCD CONFIG READ)

Value:

Sub index 1 (PCD 1)	[Parameter number]
Sub index 2 (PCD 2)	[Parameter number]

Function:

Different parameters can be assigned to PCD 1-2 if instance 101/151 is selected in parameter 904 *PPO Selection*. The values in PCD 1-2 will be read from the selected parameters in the form of data values.

Description of choice:

The sequence of subindices corresponds to the sequence of the PCD in the PPO, i.e. subindex 1 = PCD 1, subindex 2 = PCD 2 etc. Each subindex may contain the number of any VLT parameter.

Note that subindex 3 - 8 are having no function.

918 User address

(STATION ADDRESS)

Value:

0 - 63	★ 63
--------	------

Function:

Readout of actual address of the devicenet option.

927 PCV operating authority

(PARAMETER EDIT)

Value:

Without DeviceNet (DISABLE)	[0]
★With DeviceNet (ENABLE)	[1]

Function:

The parameter channel PCV may be blocked so that the modification of parameters through this channel is not possible. Access through the standard RS 485 interface is still possible.



NB!:

When parameters 927 and 928 are deactivated, the "Warning 34" in the display of the VLT will also be suppressed.

Description of choice:

- Without DeviceNet: Parameter processing through the DeviceNet is not active.
- With DeviceNet: Parameter processing through the DeviceNet is active

VLT® 5000/ 5000 FLUX/ 6000 HVAC/ 8000 AQUA DeviceNet

928 Control authority

(PROCESS CONTROL)

Value:

Without DeviceNet (DISABLE)	[0]
★With DeviceNet (ENABLE)	[1]

Function:

The process control (adjustment of control word and speed reference value and of the following variable PCD) can be blocked. Control through the control card terminals is still possible via the terminals, depending on how the parameters 502-508 have been set. Access through the standard RS 485 is also still possible.



NB!:

When parameters 927 and 928 are deactivated, the "Warning 34" in the display of the VLT will also be suppressed.

Description of choice:

- Without DeviceNet: Process control through the DeviceNet is not active.
- With DeviceNet: Process control through the DeviceNet is active



NB!:

The motor may start without advance warning when parameter 928 is being changed and start commands are present.

953 Warning messages

(WARNING PARAM.)

Value:

Read only (16 bit binary code)
No control panel access

Function:

A bit is assigned to every warning (see the following list)

Bit		In the following cases, bit is = "1"
0	LSB	Connection to the master is not OK
1		
2		FDL (field bus data security layer) is not OK
3		Command to erase data received
4		Current value not updated
5		FIFO overflow of the spontaneous messages
6		DeviceNet ASIC does not transmit
7		Initialization of the DeviceNet option is not OK
8		Not used
9		Not used
10		Not used
11		Not used
12		Not used
13		Not used
14		Not used
15	MSB	Not used

967 Control Word

(CONTROL WORD)

Value:

16 bit binary code

Function:

Parameter 967 is dedicated to sending a control word to the VLT frequency converter when using explicit message. This parameter is not available via LCP.

968 Status Word

(STATUS WORD)

Value:

Read only (16 bit binary code)

Function:

Parameter 968 is dedicated to read the status word from the VLT frequency converter when using explicit message. This parameter is not available via LCP.

970 Parameter setup selection

(EDIT SETUP SELECT)

Value:

Factory setting ()	[0]
Parameter setup 1 (SETUP 1)	[1]
Parameter setup 2 (SETUP 2)	[2]
Parameter setup 3 (SETUP 3)	[3]
Parameter setup 4 (SETUP 4)	[4]

★ = factory setting. () = display text [] = value for use in communication via serial communication port

★Active set up (ACTIVE SETUP) [5]

Function:

Like parameter 005 (described in the product manual for the VLT 2800 series).

Description of choice:

It is only possible to write to the active set-up via DeviceNet in the VLT 2800/FCD 300. This means that it is **not** possible to run for instance in set-up 1 and change data in set-up 2, 3 or 4.

971 Save date values

(STORE DATA VALUE)

Value:

★Not active (OFF)	[0]
Save active setup (STORE ACTIVE SETUP)	[1]
Save edit setup (STORE EDIT SETUP)	[2]
Save all setups (STORE ALL SETUPS)	[3]
Store Always (STORE ALWAYS)	[4]

Function:

Parameter values modified through DeviceNet are only saved in RAM, i.e. the modifications are lost in the event of a power failure. This parameter is used to activate a function by means of which all parameter values are saved in EEPROM, preserving them even in the case of a power failure.

Description of choice:

- *Not active:* The function is not active.
- *Save active setup:* All parameter setups of the active setup are saved in EEPROM. The value returns to Not active after all parameter values have been saved.
- *Save edit setup:* All parameter setups of the setup being processed are saved in EEPROM. The value returns to Not active after all parameter values have been saved.
- *Save all setups:* All parameter setups in all setups are saved in EEPROM. The value returns to Not active after all parameter values have been saved.
- *Store Always:* Each parameter write request will automatically be stored in EEPROM.



NB!:

Please note that continuous writing via explicit message may damage the EEPROM.

980–982 Defined parameters

(DEFINED PARAM.)

Value:

Read only

Function:

The three parameters contain a list of all parameters defined in the VLT. Each of the three parameters can be read as an array by means of a explicit message.

Each parameter contains up to 116 elements (parameter numbers). The number of parameters that are in use (980, 981 and 982) depends on the respective VLT configuration.

When a 0 is issued as a parameter number, the list ends.

990–992 Modified parameters

(MODIFI. PARAM.)

Value:

Read only

Function:

The three parameters contain a list of all parameters that have been changed from the factory setting. Every one of the three parameters can be read as an array with the help of the explicit read service. The subindices begin with 1 and follow the sequence of the parameter numbers. Each parameter contains up to 116 elements (parameter numbers). The number of parameters that are in use (990, 991 and 992) depends on how many parameters have been modified in comparison with the factory setting.

Pure read parameters (Read only), such as data output parameters, are not logged as modified even if they are changing.

When a 0 is issued as a parameter number, the list ends.

■ Warning and Alarm Messages

There is a clear distinction between alarms and warnings. In the case of an alarm, The VLT will enter a fault condition. After the cause for the alarm has been cleared, the master will have to acknowledge the alarm message for the VLT to start operating again. A warning on the other hand may come when a warning condition appears, and disappear when conditions return to normal without interfering with the process.

■ Warnings

Any warning within the VLT is represented by a single bit within a warning word. A warning word is always an action parameter. Bit status FALSE [0] means no warning, while bit status TRUE [1] means warning. To each bit and each bit status there is a corresponding text string. In addition to the warning word message the master will also be notified through a change of bit 7 in the Status Word.

■ Alarms

Following an Alarm message the VLT will enter Fault condition. Only after the fault has been alleviated and the master has acknowledged the alarm message by setting bit 3 in the Control Word, can the VLT resume operation. Any warning within the VLT is represented by a single bit within a warning word. A warning word is always an action parameter. Bit status FALSE [0] means no fault, while bit status TRUE [1] means fault. To each bit and each bit status there is a corresponding text string.

■ Factory Settings

PNU #	Parameter description	Factory setting	Changes during operation	4-Setup	Conversion index	Data type
001	Language	English	Yes	No	0	5
002	Local/remote control	Remote control	Yes	Yes	0	5
003	Local reference	000.000	Yes	Yes	-3	4
004	Active setup	Setup 1	Yes	No	0	5
005	Programming setup	Active setup	Yes	No	0	5
006	Copying of setups	No copying	No	No	0	5
007	LCP copy	No copying	No	No	0	5
008	Display scaling of motor frequency	1	Yes	Yes	-2	6
009	Display line 2	Frequency [Hz]	Yes	Yes	0	5
010	Display line 1.1	Reference [%]	Yes	Yes	0	5
011	Display line 1.2	Motor current [A]	Yes	Yes	0	5
012	Display line 1.3	Power [kW]	Yes	Yes	0	5
013	Local control/configura	LCP digital control/as par.100	Yes	Yes	0	5
014	Local stop	Possible	Yes	Yes	0	5
015	Local jog	Not possible	Yes	Yes	0	5
016	Local reversing	Not possible	Yes	Yes	0	5
017	Local reset of trip	Possible	Yes	Yes	0	5
018	Lock for data change	Not locked	Yes	Yes	0	5
019	Operating state at power-up, local control	Forced stop, use saved ref.	Yes	Yes	0	5

Changes during operation:

"Yes" means that the parameter can be changed, while the VLT frequency converter is in operation.

"No" means that the VLT frequency converter must be stopped before a change can be made.

4-Setup:

"Yes" means that the parameter can be programmed individually in each of the four setups, i.e. the same parameter can have four different data values. "No" means that the data value will be the same in all four setups.

Conversion index:

This number refers to a conversion figure to be used when writing or reading by means of a VLT frequency converter.

Conversion index	Conversion factor
74	0.1
2	100
1	10
0	1
-1	0.1
-2	0.01
-3	0.001
-4	0.0001

Data type:

Data type shows the type and length of the telegram.

Data type	Description
3	Integer 16
4	Integer 32
5	Unsigned 8
6	Unsigned 16
7	Unsigned 32
9	Text string

**VLT® 5000/ 5000 FLUX/ 6000 HVAC/
8000 AQUA DeviceNet**

PNU #	Parameter description	Factory setting	Changes during operation	4-Setup	Conversion index	Data type
100	Configuration	Speed control, open loop	No	Yes	0	5
101	Torque characteristics	High - constant torque	Yes	Yes	0	5
102	Motor power	Depends on the unit	No	Yes	1	6
103	Motor voltage	Depends on the unit	No	Yes	0	6
104	Motor frequency	50 Hz / 60 Hz	No	Yes	0	6
105	Motor current	Depends on the unit	No	Yes	-2	7
106	Rated motor speed	Depends on the unit	No	Yes	0	6
107	Automatic motor adaptation, AMA	Adaptation off	No	No	0	5
108	Stator resistor	Depends on the unit	No	Yes	-4	7
109	Stator reactance	Depends on the unit	No	Yes	-2	7
110	Motor magnetizing, 0 rpm	100 %	Yes	Yes	0	6
111	Min. frequency normal magnetizing	1.0 Hz	Yes	Yes	-1	6
112						
113	Load compensation at low speed	100 %	Yes	Yes	0	6
114	Load compensation at high speed	100 %	Yes	Yes	0	6
115	Slip compensation	100 %	Yes	Yes	0	3
116	Slip compensation time constant	0.50 s	Yes	Yes	-2	6
117	Resonance dampening	100 %	Yes	Yes	0	6
118	Resonance dampening time constant	5 ms	Yes	Yes	-3	6
119	High starting torque	0.0 sec.	Yes	Yes	-1	5
120	Start delay	0.0 sec.	Yes	Yes	-1	5
121	Start function	Coasting in start delay time	Yes	Yes	0	5
122	Function at stop	Coasting	Yes	Yes	0	5
123	Min. frequency for activating function at stop	0.0 Hz	Yes	Yes	-1	5
124	DC holding current	50 %	Yes	Yes	0	6
125	DC braking current	50 %	Yes	Yes	0	6
126	DC braking time	10.0 sec.	Yes	Yes	-1	6
127	DC brake cut-in frequency	Off	Yes	Yes	-1	6
128	Motor thermal protection	No protection	Yes	Yes	0	5
129	External motor fan	No	Yes	Yes	0	5
130	Start frequency	0.0 Hz	Yes	Yes	-1	5
131	Initial voltage	0.0 V	Yes	Yes	-1	6

**VLT® 5000/ 5000 FLUX/ 6000 HVAC/
8000 AQUA DeviceNet**

PNU #	Parameter description	Factory setting	Changes during operation	4-Setup	Conversion index	Data type
200	Output frequency range/direction	Only clockwise, 0-132 Hz	No	Yes	0	5
201	Output frequency low limit	0.0 Hz	Yes	Yes	-1	6
202	Output frequency high limit	66 / 132 Hz	Yes	Yes	-1	6
203	Reference/feedback area	Min - max	Yes	Yes	0	5
204	Minimum reference	0.000	Yes	Yes	-3	4
205	Maximum reference	50.000	Yes	Yes	-3	4
206	Ramp type	Linear	Yes	Yes	0	5
207	Ramp-up time 1	Depends on unit	Yes	Yes	-2	7
208	Ramp-down time 1	Depends on unit	Yes	Yes	-2	7
209	Ramp-up time 2	Depends on unit	Yes	Yes	-2	7
210	Ramp-down time 2	Depends on unit	Yes	Yes	-2	7
211	Jog ramp time	Depends on unit	Yes	Yes	-2	7
212	Quick stop ramp-down time	Depends on unit	Yes	Yes	-2	7
213	Jog frequency	10.0 Hz	Yes	Yes	-1	6
214	Reference function	Sum	Yes	Yes	0	5
215	Preset reference 1	0.00 %	Yes	Yes	-2	3
216	Preset reference 2	0.00 %	Yes	Yes	-2	3
217	Preset reference 3	0.00 %	Yes	Yes	-2	3
218	Preset reference 4	0.00 %	Yes	Yes	-2	3
219	Catch up/slow down value	0.00 %	Yes	Yes	-2	6
220						
221	Torque limit for motor mode	160 %	Yes	Yes	-1	6
222	Torque limit for regenerative operation	160 %	Yes	Yes	-1	6
223	Warning: Low current	0.0 A	Yes	Yes	-1	6
224	Warning: High current	I _{VLT,MAX}	Yes	Yes	-1	6
225	Warning: Low frequency	0.0 Hz	Yes	Yes	-1	6
226	Warning: High frequency	132.0 Hz	Yes	Yes	-1	6
227	Warning: Low feedback	-4000.000	Yes		-3	4
228	Warning: High feedback	4000.000	Yes		-3	4
229	Frequency bypass, bandwidth	OFF	Yes	Yes	0	6
230	Frequency bypass 1	0.0 Hz	Yes	Yes	-1	6
231	Frequency bypass 2	0.0 Hz	Yes	Yes	-1	6
232	Frequency bypass 3	0.0 Hz	Yes	Yes	-1	6
233	Frequency bypass 4	0.0 Hz	Yes	Yes	-1	6
234	Motor phase monitor	Enable	Yes	Yes	0	5

**VLT® 5000/ 5000 FLUX/ 6000 HVAC/
8000 AQUA DeviceNet**

PNU #	Parameter description	Factory setting	Changes during operation	4-Setup	Conversion index	Data type
300	Terminal 16, input	Reset	Yes	Yes	0	5
301	Terminal 17, input	Freeze reference	Yes	Yes	0	5
302	Terminal 18 Start, input	Start	Yes	Yes	0	5
303	Terminal 19, input	Reversing	Yes	Yes	0	5
304	Terminal 27, input	Coasting stop, inverse	Yes	Yes	0	5
305	Terminal 29, input	Jog	Yes	Yes	0	5
306	Terminal 32, input	Choice of setup, msb/speed up	Yes	Yes	0	5
307	Terminal 33, input	Choice of setup, lsb/speed down	Yes	Yes	0	5
308	Terminal 53, analogue input voltage	Reference	Yes	Yes	0	5
309	Terminal 53, min. scaling	0.0 V	Yes	Yes	-1	5
310	Terminal 53, max. scaling	10.0 V	Yes	Yes	-1	5
311	Terminal 54, analogue input voltage	No operation	Yes	Yes	0	5
312	Terminal 54, min. scaling	0.0 V	Yes	Yes	-1	5
313	Terminal 54, max. scaling	10.0 V	Yes	Yes	-1	5
314	Terminal 60, analogue input current	Reference	Yes	Yes	0	5
315	Terminal 60, min. scaling	0.0 mA	Yes	Yes	-4	5
316	Terminal 60, max. scaling	20.0 mA	Yes	Yes	-4	5
317	Time out	10 sec.	Yes	Yes	0	5
318	Function after time out	Off	Yes	Yes	0	5
319	Terminal 42, output	0 - I _{MAX} ⇒ 0-20 mA	Yes	Yes	0	5
320	Terminal 42, output, pulse scaling	5000 Hz	Yes	Yes	0	6
321	Terminal 45, output	0 - f _{MAX} ⇒ 0-20 mA	Yes	Yes	0	5
322	Terminal 45, output, pulse scaling	5000 Hz	Yes	Yes	0	6
323	Relay 01, output	Ready - no thermal warning	Yes	Yes	0	5
324	Relay 01, ON delay	0.00 sec.	Yes	Yes	-2	6
325	Relay 01, OFF delay	0.00 sec.	Yes	Yes	-2	6
326	Relay 04, output	Ready - remote control	Yes	Yes	0	5
327	Pulse reference, max. frequency	5000 Hz	Yes	Yes	0	6
328	Pulse feedback, max. frequency	25000 Hz	Yes	Yes	0	6
329	Encoder feedback pulse/rev.	1024	Yes	Yes	0	6
330	Freeze reference/output function	No operation	Yes	No	0	5

VLT® 5000/ 5000 FLUX/ 6000 HVAC/ 8000 AQUA DeviceNet

PNU #	Parameter description	Factory setting	Changes during operation	4-Setup	Conversion index	Data type
400	Brake function/overvoltage control	Off	Yes	No	0	5
401	Brake resistor, ohm	Depends on the unit	Yes	No	-1	6
402	Brake power limit, kW	Depends on the unit	Yes	No	2	6
403	Power monitoring	On	Yes	No	0	5
404	Brake check	Off	Yes	No	0	5
405	Reset function	Manual reset	Yes	Yes	0	5
406	Automatic restart time	5 sec.	Yes	Yes	0	5
407	Mains Failure	No function	Yes	Yes	0	5
408	Quick discharge	Not possible	Yes	Yes	0	5
409	Trip delay torque	Off	Yes	Yes	0	5
410	Trip delay-inverter	Depends on type of unit	Yes	Yes	0	5
411	Switching frequency	Depends on type of unit	Yes	Yes	2	6
412	Output frequency dependent switching frequency	Not possible	Yes	Yes	0	5
413	Overmodulation function	On	Yes	Yes	-1	5
414	Minimum feedback	0.000	Yes	Yes	-3	4
415	Maximum feedback	1500.000	Yes	Yes	-3	4
416	Process unit	%	Yes	Yes	0	5
417	Speed PID proportional gain	0.015	Yes	Yes	-3	6
418	Speed PID integration time	8 ms	Yes	Yes	-4	7
419	Speed PID differentiation time	30 ms	Yes	Yes	-4	6
420	Speed PID diff. gain ratio	5.0	Yes	Yes	-1	6
421	Speed PID low-pass filter	10 ms	Yes	Yes	-4	6
422	U 0 voltage at 0 Hz	20.0 V	Yes	Yes	-1	6
423	U 1 voltage	parameter 103	Yes	Yes	-1	6
424	F 1 frequency	parameter 104	Yes	Yes	-1	6
425	U 2 voltage	parameter 103	Yes	Yes	-1	6
426	F 2 frequency	parameter 104	Yes	Yes	-1	6
427	U 3 voltage	parameter 103	Yes	Yes	-1	6
428	F 3 frequency	parameter 104	Yes	Yes	-1	6
429	U 4 voltage	parameter 103	Yes	Yes	-1	6
430	F 4 frequency	parameter 104	Yes	Yes	-1	6
431	U 5 voltage	parameter 103	Yes	Yes	-1	6
432	F 5 frequency	parameter 104	Yes	Yes	-1	6
433	Torque proportional gain	100%	Yes	Yes	0	6
434	Torque integral time	0.02 sec.	Yes	Yes	-3	7
437	Process PID Normal/inverse control	Normal	Yes	Yes	0	5
438	Process PID anti windup	On	Yes	Yes	0	5
439	Process PID start frequency	parameter 201	Yes	Yes	-1	6
440	Process PID proportional gain	0.01	Yes	Yes	-2	6
441	Process PID Integral time	9999.99 sec. (OFF)	Yes	Yes	-2	7
442	Process PID differentiation time	0.00 sec. (OFF)	Yes	Yes	-2	6
443	Process PID diff. gain limit	5.0	Yes	Yes	-1	6
444	Process PID lowpass filter time	0.01	Yes	Yes	-2	6
445	Flying start	Disable	Yes	Yes	0	5
446	Switching pattern	SFAVM	Yes	Yes	0	5
447	Torque compensation	100%	Yes	Yes	0	3
448	Gear ratio	1	No	Yes	-2	4
449	Friction loss	0%	No	Yes	-2	6
450	Mains voltage at mains fault	Depends on unit	Yes	Yes	0	6

VLT® 5000/ 5000 FLUX/ 6000 HVAC/ 8000 AQUA DeviceNet

PNU #	Parameter description	Factory setting	Changes during operation	4-Setup	Conversion index	Data type
500	Address	1	Yes	No	0	6
501	Baudrate	9600 Baud	Yes	No	0	5
502	Coasting	Logic or	Yes	Yes	0	5
503	Quick-stop	Logic or	Yes	Yes	0	5
504	DC-brake	Logic or	Yes	Yes	0	5
505	Start	Logic or	Yes	Yes	0	5
506	Reversing	Logic or	Yes	Yes	0	5
507	Selection of setup	Logic or	Yes	Yes	0	5
508	Selection of speed	Logic or	Yes	Yes	0	5
509	Bus jog 1	10.0 Hz	Yes	Yes	-1	6
510	Bus jog 2	10.0 Hz	Yes	Yes	-1	6
511						
512	Telegram profile	FC Drive	No	Yes	0	5
513	Bus time interval	1 sec.	Yes	Yes	0	5
514	Bus time interval function	Off	Yes	Yes	0	5
515	Data read-out: Reference %		No	No	-1	3
516	Data read-out: Reference unit		No	No	-3	4
517	Data read-out: Feedback		No	No	-3	4
518	Data read-out: Frequency		No	No	-1	6
519	Data read-out: Frequency x Scaling		No	No	-2	7
520	Data read-out: Current		No	No	-2	7
521	Data read-out: Torque		No	No	-1	3
522	Data read-out: Power, kW		No	No	-1	7
523	Data read-out: Power, HP		No	No	-2	7
524	Data read-out: Motor voltage		No	No	-1	6
525	Data read-out: DC link voltage		No	No	0	6
526	Data read-out: Motor temp.		No	No	0	5
527	Data read-out: VLT temp.		No	No	0	5
528	Data read-out: Digital input		No	No	0	5
529	Data read-out: Terminal 53, analogue input		No	No	-2	3
530	Data read-out: Terminal 54, analogue input		No	No	-2	3
531	Data read-out: Terminal 60, analogue input		No	No	-5	3
532	Data read-out: Pulse reference		No	No	-1	7
533	Data read-out: External reference %		No	No	-1	3
534	Data read-out: Status word, binary		No	No	0	6
535	Data read-out: Brake power/2 min.		No	No	2	6
536	Data read-out: Brake power/sec.		No	No	2	6
537	Data read-out: Heat sink temperature		No	No	0	5
538	Data read-out: Alarm word, binary		No	No	0	7
539	Data read-out: VLT control word, binary		No	No	0	6
540	Data read-out: Warning word, 1		No	No	0	7
541	Data read-out: Warning word, 2		No	No	0	7

VLT® 5000/ 5000 FLUX/ 6000 HVAC/ 8000 AQUA DeviceNet

PNU #	Parameter description	Factory setting	Changes during operation	4-Setup	Conversion index	Data type
600	Operating data: Operating hours		No	No	74	7
601	Operating data: Hours run		No	No	74	7
602	Operating data: kWh counter		No	No	2	7
603	Operating data: Number of power-up's		No	No	0	6
604	Operating data: Number of overtemperatures		No	No	0	6
605	Operating data: Number of overvoltages		No	No	0	6
606	Data log: Digital input		No	No	0	5
607	Data log: Bus commands		No	No	0	6
608	Data log: Bus status word		No	No	0	6
609	Data log: Reference		No	No	-1	3
610	Data log: Feedback		No	No	-3	4
611	Data log: Motor frequency		No	No	-1	3
612	Data log: Motor voltage		No	No	-1	6
613	Data log: Motor current		No	No	-2	3
614	Data log: DC link voltage		No	No	0	6
615	Fault log: Error code		No	No	0	5
616	Fault log: Time		No	No	-1	7
617	Fault log: Value		No	No	0	3
618	Reset of kWh counter	No reset	Yes	No	0	5
619	Reset of hours-run counter	No reset	Yes	No	0	5
620	Operating mode Normal function	Normal function	No	No	0	5
621	Nameplate: VLT type		No	No	0	9
622	Nameplate: Power section		No	No	0	9
623	Nameplate: VLT ordering number		No	No	0	9
624	Nameplate: Software version no.		No	No	0	9
625	Nameplate: LCP identification no.		No	No	0	9
626	Nameplate: Database identification no.		No	No	-2	9
627	Nameplate: Power section identification no.		No	No	0	9
628	Nameplate: Application option type		No	No	0	9
629	Nameplate: Application option ordering no.		No	No	0	9
630	Nameplate: Communication option type		No	No	0	9
631	Nameplate: Communication option ordering no.		No	No	0	9

**VLT® 5000/ 5000 FLUX/ 6000 HVAC/
8000 AQUA DeviceNet**

PNU #	Parameter description	Factory setting	Changes during operation	4-setup	Conversion index	Data-type
700	Relay 6, function	Ready signal	Yes	Yes	0	5
701	Relay 6, ON delay	0 sec.	Yes	Yes	-2	6
702	Relay 6, OFF delay	0 sec.	Yes	Yes	-2	6
703	Relay 7, function	Motor running	Yes	Yes	0	5
704	Relay 7, ON delay	0 sec.	Yes	Yes	-2	6
705	Relay 7, OFF delay	0 sec.	Yes	Yes	-2	6
706	Relay 8, function	Mains ON	Yes	Yes	0	5
707	Relay 8, ON delay	0 sec.	Yes	Yes	-2	6
708	Relay 8, OFF delay	0 sec.	Yes	Yes	-2	6
709	Relay 9, function	Fault	Yes	Yes	0	5
710	Relay 9, ON delay	0 sec.	Yes	Yes	-2	6
711	Relay 9, OFF delay	0 sec.	Yes	Yes	-2	6



NB!:

This VLT Parameter List is only valid when Relay Option is installed.

**VLT® 5000/ 5000 FLUX/ 6000 HVAC/
8000 AQUA DeviceNet**

PNU #	Parameter description	Factory setting	Changes during operation	4-Setup	Conversion index	Data type	
700	System control		0 - 1	Yes	No	0	6
701	Program number	- 1	-1 - 127	Yes	No	0	4
702	PID, Proportional factor	30	0 - 65000	Yes	No	0	4
703	PID, Derivative factor	0	0 - 65000	Yes	No	0	4
704	PID, Integral factor	0	0 - 65000	Yes	No	0	4
705	PID, Integral bandwidth	1000	0 - 1000	Yes	No	0	4
706	PID, BANDWIDTH	1000	0 - 65000	Yes	No	0	4
707	PID, Velocity Feed-forward	0	0 - 65000	Yes	No	0	4
708	PID, Acceleration Feed-forward	0	0 - 65000	Yes	No	0	4
709	PID, Velocity filter	0	0 - 65000	Yes	No	0	4
710	User parameter 10	0	Defined by user ¹	Yes	No	0	4
711	User parameter 11	0	Defined by user ¹	Yes	No	0	4
...							
778	User parameter 78	0	Defined by user ¹	Yes	No	0	4
779	User parameter 79	0	Defined by user ¹	Yes	No	0	4
780	Activated dead time compensation	OFF	0 - 1	No	No	0	4
795	User parameter 95 (read only)	0	Defined by user ¹	Read only	No	0	4
796	User parameter 96(read only)	0	Defined by user ¹	Read only	No	0	4
797	User parameter 97(read only)	0	Defined by user ¹	Read only	No	0	4
798	User parameter 98(read only)	0	Defined by user ¹	Read only	No	0	4
799	User parameter 99(read only)	0	Defined by user ¹	Read only	No	0	4



NB!:

This VLT Parameter List is only valid when Sync/Pos option is installed.

1) The maximum range is -2^{32} to $2^{32} - 1$ (-2147483648 to 2147483647) but the actual range is specified when defining a user parameter in the application program using LINKGPAR or LINKAXPAR.

■ Factory settings

PNU #	Parameter description	Factory setting	Changes during operation	4-Setup	Conversion index	Data type
801	Baud rate selection				-1	3
803	Time after bus error	1 sec.			-1	3
804	Response after bus error	Off			-1	3
805	Function control word bit Bit 10	Bit 10 = CTW active			-1	6
904	PPO selection for DP	900			0	6
915	PCD write configuration				0	6
916	PCD read configuration				0	6
927	PCV operating authority	With PROFIBUS			0	6
928	Control authority	With PROFIBUS			0	6
953	Warning Messages				0	35
967	Control Word				0	35
968	Status Word				0	35
970	Parameter setup selection	Active setup			0	5
971 ^s	Save data values	Not active (OFF)			0	5**
980	Defined parameters				0	6
981						
982						
990	Modified parameters				0	
991						
992						

** Automatic reset to (0)

S Only in stop mode (VLT must be stopped in order to change data value)



VLT® 5000/ 5000 FLUX/ 6000 HVAC/ 8000 AQUA



Operating Instructions

VLT® frequency converters **BAUER** geared motors

Danfoss can accept no responsibility for possible errors in catalogues, brochures and other printed material. Danfoss reserves the right to alter its products without notice. This also applies to products already on order provided that such alterations can be made without subsequential changes being necessary in specifications already agreed. All trademarks in this material are property of the respective companies. Danfoss and the Danfoss logotype are trademarks of Danfoss A/S. All rights reserved.

