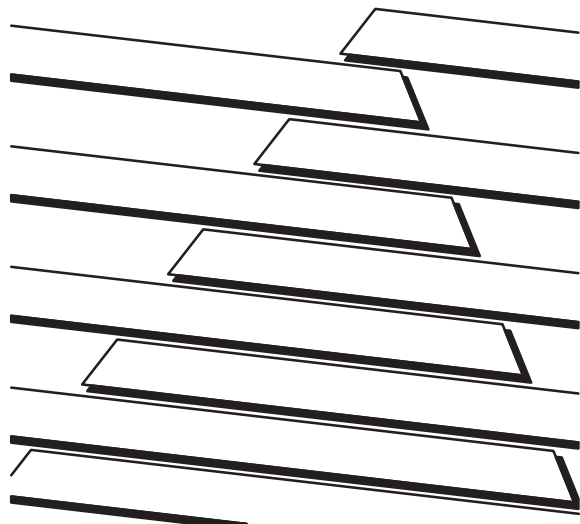




Allen-Bradley



efesotomasyon.com

Bulletin 1305 Adjustable Frequency AC Drive

1/2 - 5 HP / 0.37 - 4 kW

User Manual
FRN 1.01 – 3.00

PLEASE READ THE **ATTENTION** STATEMENT ON PAGE 2-16 AND 2-18 *BEFORE* INSTALLING THE DRIVE.



PLEASE READ!

This manual is intended to guide qualified personnel in the installation and operation of this product.

Because of the variety of uses for this equipment and because of the differences between this solid-state equipment and electromechanical equipment, the user of and those responsible for applying this equipment must satisfy themselves as to the acceptability of each application and use of the equipment. In no event will Allen-Bradley Company be responsible or liable for indirect or consequential damages resulting from the use or application of this equipment.

The illustrations shown in this manual are intended solely to illustrate the text of this manual. Because of the many variables and requirements associated with any particular installation, the Allen-Bradley Company cannot assume responsibility or liability for actual use based upon the illustrative uses and applications.

No patent liability is assumed by Allen-Bradley Company with respect to use of information, circuits or equipment described in this text.

Reproduction of the content of this manual, in whole or in part, without written permission of the Allen-Bradley Company is prohibited.

Allen-Bradley

IMPORTANT USER INFORMATION

The information in this manual is organized in numbered chapters. Read each chapter in sequence and perform procedures when you are instructed to do so. Do not proceed to the next chapter until you have completed all procedures.

Throughout this manual we use notes to make you aware of safety considerations:



ATTENTION: Identifies information about practices or circumstances that can lead to personal injury or death, property damage or economic loss.

Attentions help you:

- identify a hazard
- avoid the hazard
- recognize the consequences

IMPORTANT: Identifies information that is especially important for successful application and understanding of the product.

Summary Information

We would like to call your attention to the following changes to this manual which have occurred since the previous version published in June, 1995. All references to page numbers refer to the November, 1995 publication.

Chapter 2

- An Installations Guidelines Figure was added to page 2-4.
 - An Input Devices section was added before Input Power Conditioning on page 2-5.
 - Starting and Stopping the Motor was moved from the Input Power Conditioning section to the Input Devices section on page 2-5.
 - Two sentences were added to the first paragraph on page 2-6.
 - Basic rules for determining line reactor or isolation type transformer requirements was added to the Input Power Conditioning section on page 2-6.
 - An Input Fusing heading was added above the first ATTENTION statement on page 2-6.
 - The following sections were added after Input Power Conditioning beginning on page 2-7:
 - Electrical Interference EMI/RFI
 - RFI Filtering
 - Grounding
 - A page reference has been added to the first paragraph under Power Wiring on page 2-11.
- The following subsections were added to Power Wiring beginning on page 2-11:
 - Motor Cables
 - Shielded Cable
 - Conduit
 - Motor Lead Lengths
 - Cable Charging Current
 - Common Mode Cores
 - A sentence was added to the paragraph following Drive Operation Without a Human Interface Module (HIM) on page 2-15.
 - Three sentences were added under ATTENTION following the Control Wiring heading on page 2-15.
 - An IMPORTANT was added following Table 2.F on page 2-18.
 - “Contact Closure Input” was added to footnote ③ on page 2-18.
 - A reference to Output Devices was added on page 2-19.
 - An Output Devices heading was added above Drive Output Disconnection on page 2-19. This section now follows Table 2.D in page 2-13.
 - A Cable Termination section was added before the Adapters section on page 2-19.

Chapter 3

- Footnotes were added to Figure 3.3 on page 3-6.
- The EEPROM Mode section starting on page 3-10 was modified.

Chapter 6

- An IMPORTANT statement was added above the third paragraph on page 6-1.

- The Diagnostics section on page 2-6 was moved to Chapter 6.
- A footnote was added to Table 6.A on page 6-2.
- Additional fault information was added to Table 6.A on page 6-2.

Appendix B

- Max Value for Data In and Data Out Parameters in Table B.4 on page B-11 was changed.

Chapter 1 – Information and Precautions

Chapter Objectives 1-1
 Manual Objectives 1-1
 Receiving, Unpacking, Inspection, Storing 1-2
 General Precautions 1-2
 Conventions Used In This Manual 1-4
 Nameplate Location 1-4
 Firmware Compatibility 1-4
 Catalog Number Code Explanation 1-5

Chapter 2 – Installation/Wiring

Chapter Objectives 2-1
 Mounting Requirements 2-1
 Dimensions 2-2
 Terminal Block Access 2-3
 Input Devices 2-5
 Starting and Stopping the Motor 2-5
 Repeated Application/Removal of Input Power 2-5
 Bypass Contactors 2-5
 Input Power Conditioning 2-6
 Input Fusing 2-6
 Electrical Interference EMI/RFI 2-7
 Immunity 2-7
 Emission 2-7

efesotomasyon.com

RFI Filtering 2-8
 RFI Filtering Installation 2-8
 RFI Filter Leakage Current 2-8
 Grounding 2-9
 Sensitive Currents 2-9
 Motor Cable 2-9
 Discrete Control and Signal Wiring 2-9
 Safety Ground 2-9
 RFI Filter 2-9
 Power Wiring 2-10
 Motor Cables 2-12
 Shielded Cable 2-12
 Conduit 2-13
 Motor Lead Lengths 2-13
 Cable Charging Currents 2-14
 Common More Codes 2-14
 Drive Operation Without A HIM 2-15
 Frequency Source 2-15
 Control Wiring 2-15
 Three Wire Control 2-16
 Two Wire “Run Forward/Run Reverse” Control 2-16
 Output Devices 2-19
 Drive Output Disconnection 2-19
 Cable Termination 2-19
 Optional Cable Terminator 2-19
 Optional Cable Reactor 2-19

Adapters 2-20
 Adapter Mounting Distance 2-20
 Adapter Mounting Distance & Cable Connections . . . 2-21

Chapter 3 – Human Interface Module (HIM)

Chapter Objectives 3-1
 HIM Description 3-1
 HIM Operation 3-1
 Display Panel Descriptions 3-2
 Control Panel Descriptions 3-2
 HIM Removal And Installation 3-4
 HIM Modes 3-5
 HIM Programming Steps 3-6
 Program And Display Modes 3-7
 Process Mode 3-9
 EEProm Mode 3-10
 Search Mode 3-13
 Control Status Mode 3-14
 Fault Queue/Clear Faults 3-15
 Password Mode 3-16
 Login to the Drive 3-17
 Logout from the Drive 3-19

Chapter 4 – Start-Up

Chapter Objectives 4-1
 Start-Up Procedure 4-1
 Initial Operation - Motor Disconnected 4-2

Chapter 5 – Programming

Chapter Objectives 5-1
 Chapter Conventions 5-1
 Function Index 5-1
 Parameter Flow Chart 5-2
 Programming Example 5-4
 Metering Group 5-5
 Set Up Group 5-8
 Single Phase Input Ratings 5-14
 Advanced Setup Group 5-15
 Frequency Set Group 5-24
 Frequency Source Selection 5-27
 Accel/Decel Selection 5-28
 Feature Select Group 5-30
 Output Configuration Group 5-34
 Faults Group 5-36
 Diagnostics Group 5-38
 Masks Group 5-43
 Owners Group 5-46
 Adapter I/O Group 5-50
 Process Display Group 5-52
 Linear List 5-53

Chapter 6 – Troubleshooting and Fault Information

Chapter Objectives	6-1
Fault Information	6-1
Fault LED	6-1
Diagnostics	6-1
How To Clear a Fault	6-1
Fault Code Cross Reference	6-2
Fault Descriptions	6-3
Troubleshooting	6-9

Appendix A – Block Diagram and Specifications

Block Diagram	A-1
Specifications	A-2
Output Ratings	A-2
Input Ratings	A-2
Environmental Specifications	A-3
Control Inputs	A-3

Control Outputs	A-4
Control Features	A-4
Protective Features	A-5
Programming/Communications	A-6
Monitoring	A-6

Appendix B – Serial Communications

Communications Using Bulletin 1203 Communication Modules	B-1
Logic Control Data	B-3
Drive Status Data	B-4
Parameter Grouping/User Settings	B-5
Scale Factor Conversion	B-13

Appendix C – Accessories

Accessories	C-1
-------------------	-----

Index

Index	I-1
-------------	-----

This Page Intentionally Left Blank.

CHAPTER OBJECTIVES

Chapter 1 provides information on the general intent of this manual, gives an overall description of the Bulletin 1305 Adjustable Frequency AC Drive (herein called - the drive) and provides a listing of key drive options. Additionally, this chapter provides information on receiving and handling of the drive.

MANUAL OBJECTIVES

The purpose of this manual is to provide the user with the necessary information to install, program, start up and maintain the Bulletin 1305 drive. To assure successful installation and operation, the material presented must be thoroughly read and understood before proceeding. Particular attention must be directed to the **ATTENTION** and **IMPORTANT** statements contained within.

Chapter 2 provides instructions on how to mount and wire the drive. It also describes how to operate the drive without a Human Interface Module.

Chapter 3 defines the display and control panel keys on the optional Human Interface Module. A flowchart is provided to guide the user through the key strokes of the various menu levels.

Chapter 4 describes the steps to start up the drive. It includes a typical start up routine defining the adjustments and checks to assure proper operation.

Chapter 5 outlines the parameter information of the drive such as description, number, type, units, factory default, minimum and maximum settings.

Chapter 6 defines the various drive faults and the appropriate action to take as well general troubleshooting information.

Appendix A contains a block diagram and general specifications of the drive.

Appendix B provides the necessary information for drive set up using a PLC[®], SLC[™] or other logic controller. A table is provided that lists each parameter by parameter group with space for the user to record any custom parameter settings.

Appendix C lists the accessories and their catalog number.

Index – A comprehensive index is provided to assist the user in locating specific information. All parameters and fault information are listed alphabetically under parameters and faults respectively.

PLC is a registered trademark of Allen-Bradley Company.

SLC is a trademark of Allen-Bradley Company.

Receiving – It is the responsibility of the user to thoroughly inspect the equipment before accepting the shipment from the freight company. Check the item(s) received against the purchase order. If any items are obviously damaged, it is the responsibility of the user not to accept delivery until the freight agent has noted the damage on the freight bill. Should any concealed damage be found during unpacking, it is again the responsibility of the user to notify the freight agent. The shipping container must be left intact and the freight agent should be requested to make a visual inspection of the equipment.

Unpacking – Remove all packing material, wedges, or braces from within and around the drive. Remove all packing material from the heat sink.

IMPORTANT: Before the installation and start-up of the drive, a general inspection of the mechanical integrity (i.e. loose parts, wires, connections, etc.) should be made.

Inspection – After unpacking, check the item(s) nameplate catalog number against the purchase order. An explanation of the catalog numbering system for the Bulletin 1305 drive is

included as an aid for nameplate interpretation. Refer to the following pages for complete nomenclature.

Storing – The drive should remain in its shipping container prior to installation. If the equipment is not to be used for a period of time, it must be stored according to the following instructions in order to maintain warranty coverage:

- Store in a clean, dry location.
- Store within an ambient temperature range of -40° to +70°C.
- Store within a relative humidity range of 0% to 95%, noncondensing.
- Do not store equipment where it could be exposed to a corrosive atmosphere.
- Do not store equipment in a construction area.

GENERAL PRECAUTIONS

In addition to the precautions listed throughout this manual, the following statements which are general to the system must be read and understood.



ATTENTION: This drive contains ESD (Electrostatic Discharge) sensitive parts and assemblies. Static control precautions are required when installing, testing, servicing or repairing this assembly. Component damage may result if ESD control procedures are not followed. If you are not familiar with static control procedures, reference A-B publication 8000-4.5.2, “*Guarding Against Electrostatic Damage*” or any other applicable ESD protection handbook.



ATTENTION: An incorrectly applied or installed drive can result in component damage or a reduction in product life. Wiring or application errors, such as, undersizing the motor, incorrect or inadequate AC supply, or excessive ambient temperatures may result in malfunction of the system.



ATTENTION: Only personnel familiar with the the drive and associated machinery should plan or implement the installation, start-up and subsequent maintenance of the system. Failure to comply may result in personal injury and/or equipment damage.

CONVENTIONS USED IN THIS MANUAL

Programmer Terminal will appear as Human Interface Module or HIM.

To help differentiate parameter names, display text, and control keys from other text in this manual, the following conventions will be used:

Parameter Names will appear in **[brackets]**

Display Text will appear in “quotes”.

Control Key Names will appear as depicted on the control key, if the key is labeled with letters or numbers (i.e., JOG, SEL) or if the key depicts an icon, its operative term appear with initial capitalization (i.e., Stop, Increment, Enter).

NAMEPLATE LOCATION

Figure 1.1 Bulletin 1305 Nameplate Location

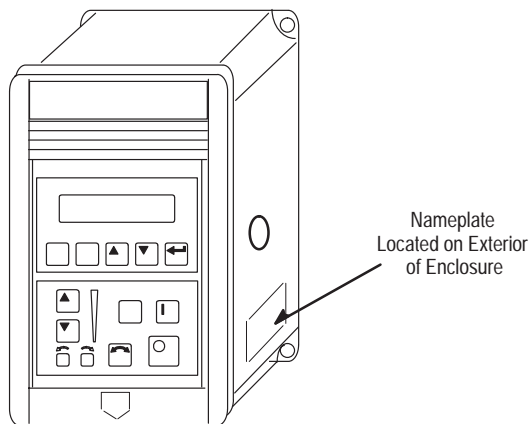


Figure 1.2 Nameplate Information

CAT 1305-AA04A-HA2		SER A	
S/N 00110			
I N P U T	V: 200-240	O U T P U T	V: 200-230 3Ø
	A: 4.0		A: 4.5
	Hz: 50/60	Hz: 0-400	Motor Rating: 0.75kW/1HP
	VA: 1700		
ALLEN-BRADLEY		MADE IN U.S.A.	

FIRMWARE COMPATIBILITY^①

Drive: FRN 1.0 through 3.0

HIM: FRN 1.0 through 3.0

^① *Specific Firmware versions are identified by digits to the right/left of decimal.
Example 1.01, 2.01, 3.00.*

CATALOG NUMBER CODE EXPLANATION

1305 – First Position	A Second Position	A02 Third Position	A Fourth Position	– DE Fifth Position	– HA1 Sixth Position
Bulletin Number	Rating	Nominal Current Rating	Enclosure Type		Options
	A 200-240V 1Ø 200-230V 3Ø B 380-460V 3Ø	A01 A02 A03 A04 A06 A08 A09 A12	<u>Letter</u> A <u>Enclosure Type</u> NEMA Type 1 (IP 30)		

Language Code (English language is included in base catalog number. To order a second language, add the appropriate suffix to the drive catalog number.)

DE	German
ES	Spanish
IT	Italian
FR	French

Human Interface Modules, NEMA Type 1 (IP 30) To order installed in the drive, add the appropriate suffix to the drive catalog number.

HAP	Programmer Only
HA1	HIM with Analog Speed Pot
HA2	HIM with Digital Up-Down Keys

Table 1.A Drive Rating and Derating Guidelines

Voltage Rating	Catalog Number IP30	Motor Rating					
		3 ∅ Input			1 ∅ Input		
		HP	kW	Output ^{①②} Current (A)	HP	kW	Output ^{①②} Current (A)
200-230V 50/60 Hz	1305-AA02A	1/2	0.37	2.3	–	–	–
	1305-AA03A	3/4	0.55	3	1/2	0.37	2.3
	1305-AA04A	1	0.75	4.5	3/4	0.55	3
	1305-AA08A	2	1.5	8	1	0.75	4.5
	1305-AA12A	3	2.2	12 ^③	2	1.5	8 ^③
380-460V 50/60 Hz	1305-BA01A	1/2	0.37	1.3	Not Available		
	1305-BA02A	3/4	0.55	1.6			
	1305-BA03A	1	0.75	2.3			
	1305-BA04A	2	1.5	4			
	1305-BA06A	3	2.2	6 ^④			
	1305-BA09A	5	4.0	9 ^⑤			

In general:

When operating the drive in an ambient temperature at or near the maximum operating temperature (50°C), the following derating guidelines are recommended to guard against overheating depending on application and operating conditions.

- ① Motor Full Load Amps (FLA) should not exceed the drive output current rating.
- ② If the [PWM Frequency] is set above 4kHz, the output current must be derated per the chart on page 5-20.
- ③ Output current value listed for 200V input voltage. At 230V input voltage, output current is 9.6A for 3 phase and 6.8A for single phase.
- ④ Output current value listed for 380V input voltage. At 415V input voltage, output current is 5.3A. At 460V input voltage, output current is 4.8A.
- ⑤ Output current value listed for 380V input voltage. At 415V input voltage, output current is 8.4A. At 460V input voltage, output current is 7.6A.

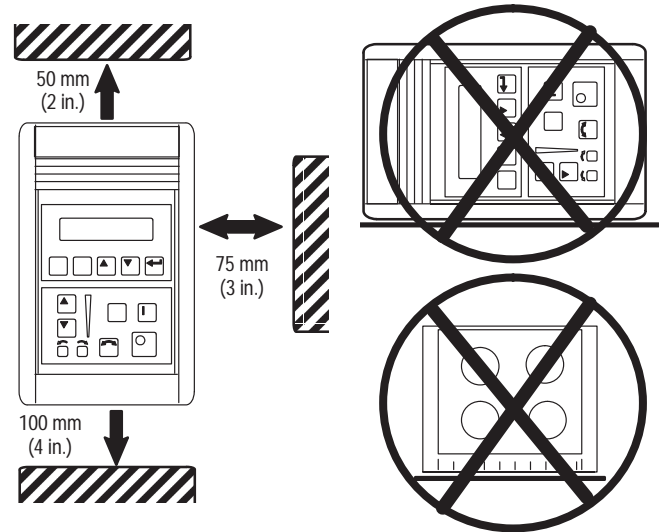
CHAPTER OBJECTIVES

Chapter 2 provides the information needed to properly mount and wire the drive. Since most start-up difficulties are the result of incorrect wiring, every precaution must be taken to assure that the wiring is done as instructed. All items must be read and understood before the actual installation begins.



ATTENTION: The following information is merely a guide for proper installation. The National Electrical Code and any other governing regional or local code will overrule this information. The Allen-Bradley Company cannot assume responsibility for the compliance or the noncompliance to any code, national, local or otherwise for the proper installation of this drive or associated equipment. A hazard of personal injury and/or equipment damage exists if codes are ignored during installation.

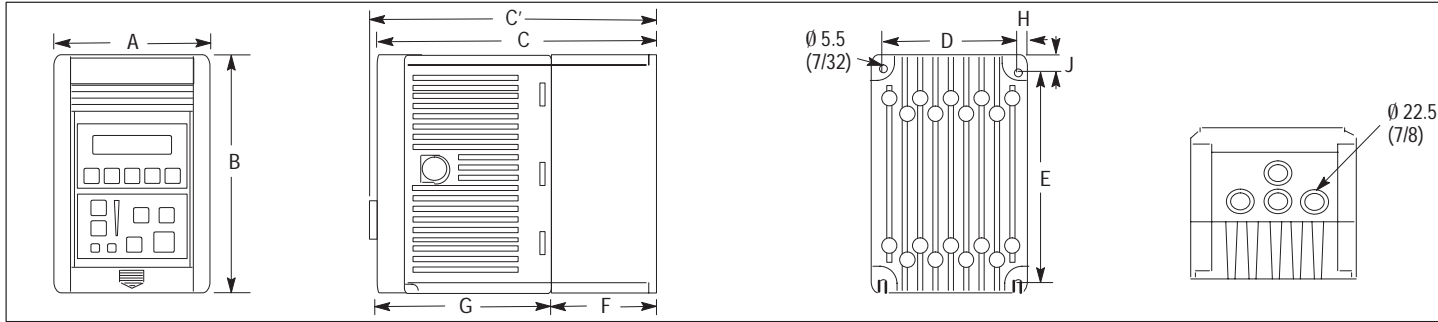
Figure 2.1 Mounting Requirements



IMPORTANT: The drive must be mounted to a metallic surface.

Figure 2.2 Bulletin 1305 Approximate Dimensions

Dimensions shown in millimeters (inches). Shipping weights shown in kilograms (pounds).



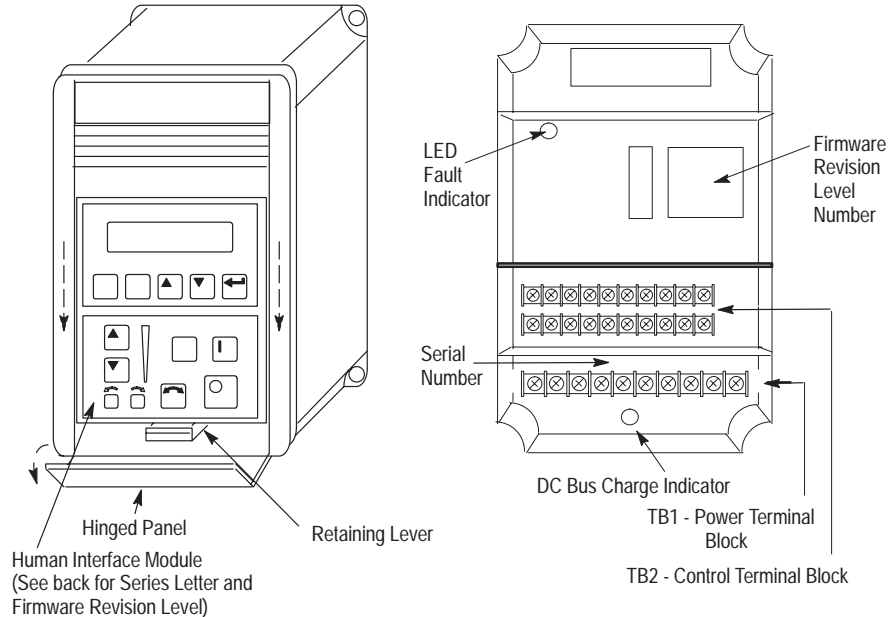
200/230 V Cat. No. 1305-	380/460 V Cat. No. 1305-	A Width	B Height	C Depth w/o Pot	C' Depth w/ Pot	D	E	F	G	H	J	Approx. Ship Wt.
AA02A AA03A		120 (4-23/32)	195 (7-11/16)	122 (4-13/16)	127.1 (5)	110 (4-11/32)	180 (7-1/16)	9 (11/32)	113 (4-7/16)	5 (7/32)	7.5 (5/16)	1.6 (3.5)
AA04A		120 (4-23/32)	195 (7-11/16)	140 (5-1/2)	145.1 (5-23/32)	110 (4-11/32)	180 (7-1/16)	27 (1-1/16)	113 (4-7/16)	5 (7/32)	7.5 (5/16)	1.9 (4.2)
AA08A	BA01A BA02A BA03A BA04A BA06A	170 (6-11/16)	195 (7-11/16)	179 (7-1/16)	184.1 (7-1/4)	160 (6-5/16)	180 (7-1/16)	66 (2-19/32)	113 (4-7/16)	5 (7/32)	7.5 (5/16)	3.6 (8.0)
AA12A	BA09A	210 (8-1/4)	195 (7-11/16)	179 (7-1/16)	184.1 (7-1/4)	200 (7-7/8)	180 (7-1/16)	66 (2-19/32)	113 (4-7/16)	5 (7/32)	7.5 (5/16)	4.2 (9.2)

TERMINAL BLOCK ACCESS

To access the power and control terminal blocks, perform the following procedure:

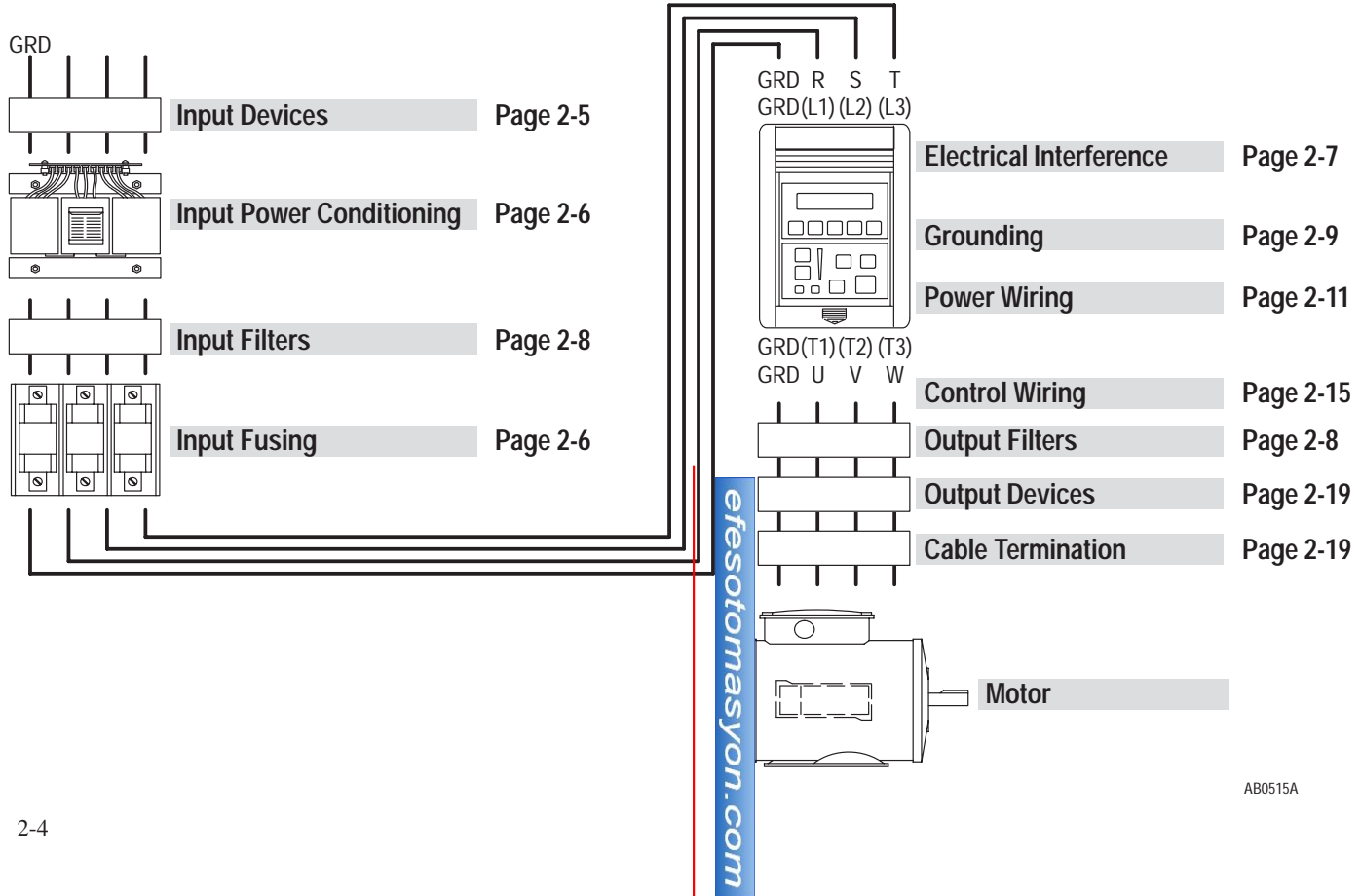
1. Remove power from the drive.
2. Lower the hinged panel located below the HIM or blank front panel.
3. For drives equipped with a blank front panel, slide the panel downward and remove from the drive. Skip to Step 5.
4. For drives equipped with a HIM, press the retaining lever directly beneath the HIM and slide the HIM downward to remove from drive.
5. Remove the front cover by grasping the upper corners of the cover and pulling the cover to a 90° angle to the drive. Lift the cover off.

Figure 2.3 Terminal Block Access



ATTENTION: Proceed with caution. A DC Bus Voltage may be present at the Power Terminal Block (TB1) even when power is removed from the drive.

Figure 2.4 Installation Guidelines



INPUT DEVICES

Starting and Stopping the Motor



ATTENTION: The drive start/stop control circuitry includes solid-state components. If hazards due to accidental contact with moving machinery or unintentional flow of liquid, gas or solids exist, an additional hardwired stop circuit is required to remove AC line power to the drive. When AC input power is removed, there will be a loss of inherent regenerative braking effect and the motor will coast to a stop. An auxiliary braking method may be required.

Repeated Application/Removal of Input Power



ATTENTION: The drive is intended to be controlled by control input signals that will start and stop the motor. A device that routinely disconnects then reapplies line power to the drive for the purpose of starting and stopping the motor should not be used. If it is necessary to use this method for starting and stopping or if frequent cycling of power is unavoidable, make sure that it does not occur more than once a minute.

Bypass Contactors



ATTENTION: An incorrectly applied or installed system can result in component damage or reduction in product life. The most common causes are:

- Wiring AC line to drive output or control terminals.
- Improper voltage placed on control terminals.
- Improper bypass or output circuits not approved by Allen-Bradley.
- Output circuits which do not connect directly to the motor.
- Incorrect or inadequate AC supply.
- Excessive ambient temperature.

Contact Allen-Bradley for assistance with application or wiring.

INPUT POWER CONDITIONING

The drive is suitable for direct connection to a correct voltage, single phase or three-phase, AC power line. However, there are certain power line conditions which may introduce the possibility of drive input power component malfunction. To reduce the possibility of these malfunctions, a line reactor or isolation type transformer with an input impedance of 3% of the drive input VA rating may be required.

The basic rules for determining if a line reactor or isolation type transformer is required are as follows:

1. If the AC line supplying the drive has power factor correction capacitors that are switched in and out, installing an AC line reactor or isolation type transformer between the capacitor bank and the drive input may be required. Damage to drives can occur from the extreme current spikes caused by capacitor switching.
2. If the AC line frequently experiences transient power interruptions or significant voltage spikes, an AC line reactor or isolation type transformer may be required. Damage to drives can occur from extreme current spikes.

INPUT FUSING



ATTENTION: The drive does not provide branch circuit protection. Specifications for the recommended fuse size and type which provide branch circuit protection against short circuits are provided in Table 2.A . Branch circuit breakers or disconnect switches cannot provide this level of protection for drive components.

**Table 2.A Maximum Recommended AC Input Line Fuse
UL Class J, T, CC, or BS88 (or equivalent)**

3Ø Rating kW (HP)	1Ø Rating kW (HP)	Fuse 230V Rating	Fuse 460V Rating
.37 (1/2)	--	6	3①
.55 (3/4)	.37 (1/2)	6	3①
.75 (1)	.55 (3/4)	10	6②
1.5 (2)	1.5 (1)	15	10②
2.2 (3)	1.5 (2)	25	15②
4.0 (5)	--	--	20②

① *Must be dual element time delay, Bussmann LPJ or equivalent.*

② *If fuse blowing is a problem, use dual element type fuses.*

ELECTRICAL INTERFERENCE – EMI/RFI

Immunity

The 1305 drive is designed for immunity to most externally generated interference. Usually, no special precautions are required beyond the installation practices provided in this publication.

It is recommended that the coils of DC energized contactors associated with drives be suppressed with a diode or similar device, since they can generate severe electrical transients.

In areas subject to frequent lightning strikes, additional surge suppression is advisable.

Emission

Careful attention must be given to the arrangement of power and ground connections to the drive to avoid interference with nearby sensitive equipment. The cable to the motor carries switched voltages and should be routed well away from sensitive equipment.

The ground conductor of the motor cable should be connected to the drive ground (GRD) terminal directly. Connecting this ground conductor to a cabinet ground point or ground bus bar may cause high frequency current to circulate in the ground system of the enclosure. The motor end of this ground conductor must be solidly connected to the motor case ground.

Shielded or armored cable may be used to guard against radiated emissions from the motor cable. The shield or armor should be connected to the drive ground terminal and the motor ground as outlined in the Grounding section of this Installation chapter.

Common mode chokes are recommended at the drive output to reduce the common mode noise.

An RFI filter can be used and in most situations provides an effective reduction of RFI emissions that may be conducted into the main supply lines.

If the installation combines a drive with sensitive devices or circuits, it is recommended that the lowest possible drive PWM frequency be programmed.

RFI FILTERING

1305 drives can be installed with an RFI filter, which controls radio–frequency conducted emissions into the main supply lines and ground wiring.

If the cabling and installation recommendation precautions described in this manual are adhered to, it is unlikely that interference problems will occur when the drive is used with conventional industrial electronic circuits and systems.

However, a filter is recommended if there is a likelihood of sensitive devices or circuits being installed on the same AC supply or if the motor cable exceeds 50 meters (164 feet). Beyond this length, capacitance to ground will increase the supply emissions.

Where it is essential that very low emission levels must be achieved or if conformity with standards is required (EN55011, VDE0875, BSI, FCC) the optional RFI filter should be used.

IMPORTANT: The conformity of the drive and filter to any standard does not guarantee that the entire installation will conform. Many other factors can influence the total installation and only direct measurements can verify total conformity.

RFI Filter Installation

The RFI filter must be connected between the incoming AC supply line and the drive power input terminals.

In general, it is best to install the filter on the same mounting plate, physically close (and with short connections) to the drive.

IMPORTANT: To assure that the RFI filter is effective, the motor cable must be shielded or armored and the guidelines given in this manual must be followed.

RFI Filter Leakage Current

The optional RFI filter may cause ground leakage currents. Therefore a solid ground connection must be provided.



ATTENTION: To guard against possible equipment damage, RFI filters can only be used with AC supplies that are nominally balanced with respect to ground. In some countries, three–phase supplies are occasionally connected in a 3-wire configuration with one phase grounded (Grounded Delta). The filter must not be used in Grounded Delta supplies.

GROUNDING

Refer to the grounding diagram on the following page. The drive must be connected to system ground at the power ground (GRD) terminal provided on the power terminal block (TB1). Ground impedance must conform to the requirements of national and local industrial safety regulations (NEC, VDE 0160, BSI, etc.) and should be inspected and tested at appropriate and regular intervals. In any cabinet, a single, low-impedance ground point or ground bus bar should be used. All circuits should be grounded independently and directly. The AC supply ground conductor should also be connected directly to this ground point or bus bar.

Sensitive Currents

It is essential to define the paths through which the high frequency ground currents flow. This will assure that sensitive circuits do not share a path with such current, and to minimize the area enclosed by these paths. Current carrying ground conductors must be separated. Control and signal ground conductors should not run near or parallel to a power ground conductor.

Motor Cable

The ground conductor of the motor cable (drive end) must be connected directly to the ground terminal, not to the enclosure bus bar. Grounding directly to the drive (and filter, if installed) provides a direct route for high frequency current returning from the motor frame and ground conductor. At the motor end,

the ground conductor should also be connected to the motor case ground. If shielded or armored cables are used, the same grounding methods should be used for the shield/armor as well.

Discrete Control and Signal Wiring

DO NOT connect drive Common terminals (TB2) to ground. DO NOT switch these inputs using non-isolated TTL type circuits. Use dry relay contacts to switch signal inputs to Common. Only isolated 4-20mA sources are recommended. There must be no ground potential difference between source and drive.

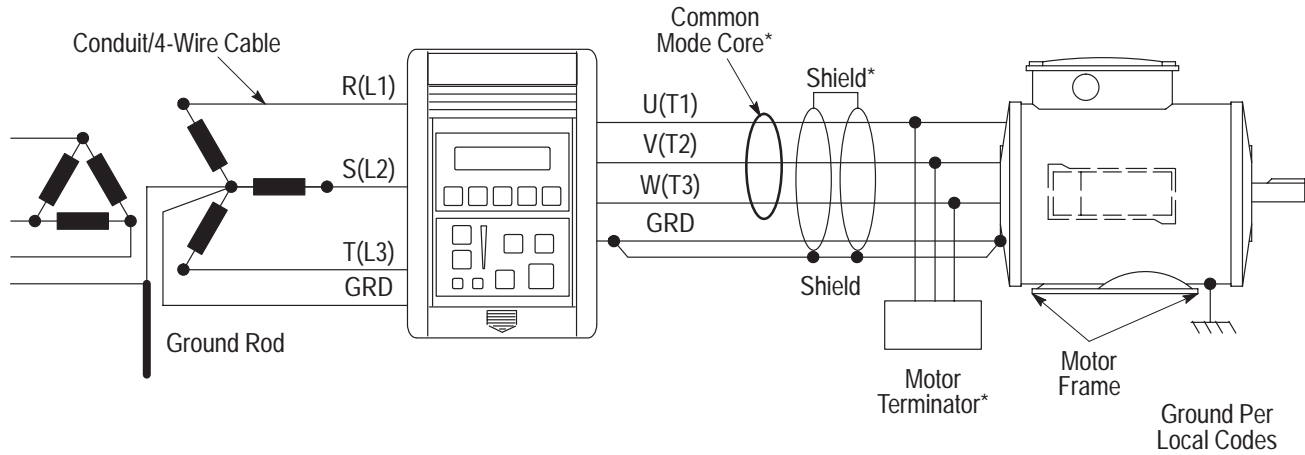
Safety Ground

This is the safety ground required by code. The ground bus can be connected to adjacent building steel (girder, joist) or a floor ground loop, provided grounding points comply with NEC regulations.

RFI Filter

IMPORTANT: Using an optional RFI filter may result in relatively high ground leakage currents. Surge suppression devices are also incorporated in the filter to clamp line surges to a limited voltage above ground potential. Therefore, the filter must be permanently installed and solidly grounded. Grounding must not rely on flexible cables and should not include any form of plug or socket that would permit inadvertent disconnection. The integrity of this connection should be periodically checked.

Figure 2.5 Recommended 1305 Grounding



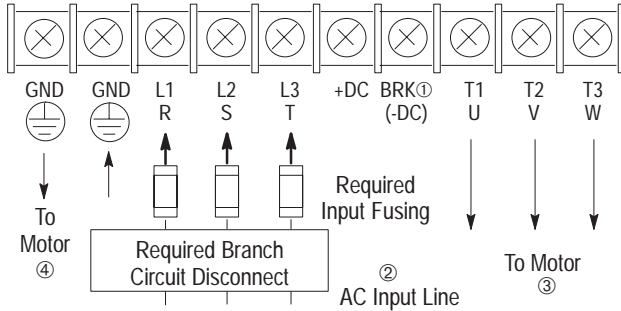
* These are options that can be installed as needed.

AB0518A

POWER WIRING

Input and output power connections are performed through a ten position terminal block, TB1 (see page 2-3 for location).

Figure 2.6 Power Terminal Block Designations (TB1)



① Connection for Dynamic Brake Resistors for all models except the 200-230 Volt, 0.37 to 0.75 kW (1/2 to 1 HP) drive. **IMPORTANT:** The [DB Enable] parameter must be enabled for proper operation.

② For single phase applications, the AC input line can be connected to any two of the three input terminals R, S, T (L1, L2, L3).

③ Bulletin 1305 drives are UL listed and CSA certified as a motor overload protective device. An external overload relay is not required for single motor applications. **IMPORTANT:** This drive is not intended for use with single phase motors.

④ Ground from drive to motor frame must be an independent continuous insulated wire run.

Table 2.B Power Block Terminal (TB1)

Terminals	Description
GND	Earth Ground
R, S, T (L1, L2, L3)	AC Input Line Terminals
+DC, BRK (or -DC)	Dynamic Brake Option - Refer to instructions included with option
U, V, W (T1, T2, T3)	Motor Connection

Table 2.C Screw Size, Wire Size and Torque Specifications

Terminal	Screw Size	Max./Min. Wire Size mm ² (AWG)	Maximum Torque N-m (lb-ins.)
TB1 (0.37 to 0.75kW/1/2 to 1 HP)	M4	3.5/0.75 (12/18)	0.90 (8)
TB1 (All except above)	M4	4/0.75 (10/18)	1.81 (16)
TB2 (All)	M3.5	1.5/0.20 (14/24)	0.90 (8)

Motor Cables

A variety of cable types are acceptable for drive installations. For many installations, unshielded cable is adequate, provided it can be separated from sensitive circuits. As an approximate guide, allow a spacing of 1 meter (3.3 feet) for every 10 meters (33 feet) of length. In all cases, long parallel runs must be avoided.

The cable should be 4-conductor with the ground lead being connected directly to the drive ground terminal (GRD) and the motor frame ground terminal.

Shielded Cable

Shielded cable is recommended if sensitive circuits or devices are connected or mounted to the machinery driven by the motor. The shield must be connected to the drive ground and motor frame ground. The connection must be made at both ends to minimize the external magnetic field.

If cable trays or large conduits are to be used to distribute the motor leads for multiple drives, shielded cable is recommended to reduce or capture the noise from the motor leads and minimize “cross coupling” of noise between leads of different

drives. The shield should be connected to the ground connections at both the motor and drive end.

Armored cable also provides effective shielding. Ideally, it should be grounded only at the drive (GRD) and motor frame. Some armored cable has a PVC coating over the armor to prevent incidental contact with grounded structure. If, due to the type of connector, the armor must be grounded at the cabinet entrance, shielded cable should be used within the cabinet to continue as far as possible to the coaxial arrangement of power cable and ground.

In some hazardous environments it is not permissible to ground both ends of the cable armor. This is because of the possibility of high current circulating at the input frequency if the ground loop is cut by a strong magnetic field. This only applies in the proximity of powerful electrical machines. In such case, the ground connection at one end may be made through a capacitance, which will block the frequency current but present a low impedance to RF. Because of the highly pulsed nature of the circulating current, the capacitor type used must be rated for AC-to-ground voltage. Consult factory for specific guidelines.

Conduit

If metal conduit is preferred for cable distribution, the following guidelines must be followed.

1. Drives are normally mounted in cabinets and ground connections are made at a common ground point in the cabinet. If the conduit is connected to the motor junction box and at the drive end, no further conduit connections are necessary.
2. No more than three sets of motor leads can be routed through a single conduit. This will minimize “cross talk” that could reduce the effectiveness of the noise reduction methods described. If more than three drive/motor connections per conduit are required, shielded cable as described above must be used. If practical, each conduit should contain only one set of motor leads.



ATTENTION: To avoid a possible shock hazard caused by induced voltages, unused wires in the conduit must be grounded at both ends. For the same reason, if a drive sharing a conduit is being serviced or installed, all drives using this conduit should be disabled. This will eliminate the possible shock hazard from “cross coupled” drive motor leads.

Motor Lead Lengths

Installations with long cables to the motor may require the addition of output reactors or cable terminators to limit voltage reflections at the motor. Refer to Table 2.D for the maximum length cable allowed for various installation techniques.

Table 2.D Recommended Motor cable Lengths

Drive Rating	Termination Type	Maximum Cable Length in meters (feet) with 460V Motor and Insulation Rating of ...		
		1000V	1200V	1600V
0.37–4.0 kW (0.5–5 HP)	None	12m (40ft)	33m (110ft)	121m (400ft)
0.37–2.2 kW (0.5–3 HP)	Reactor at Drive ^①	15m (50ft)	④	④
4.0 kW (5 HP)		15m (50ft)	182m (600ft)	④
0.37–4.0 kW (0.5–5 HP)	Reactor at Motor ^②	④	④	④
0.37–1.5 kW (0.5–2 HP)	Terminator at Motor ^③	④	④	④
2.2–4.0 kW (3–5 HP)		167m (550ft)	④	④

- ① A 3% reactor at the drive provides lower rise time and lower stress on the motor cable, but may produce a poorer waveform to the motor. The reactor must have a turn-to-turn insulation rating of 2100 volts or higher for 460V motors. Not recommended for lightly loaded motor applications because overvoltage trips may occur at low output frequencies.

- ② A 3% reactor at the motor has less effect on the rise time and higher stress on the motor cable, but will provide a better waveform to the motor. The reactor must have a turn-to-turn insulation rating of 2100 volts or higher for 460V motors.
- ③ Product information not available at the time of printing.
- ④ Use length indicated in Table 2.E

Cable Charging Current

While cable length limits for reflected wave protection should be followed, drives may have additional cable length restrictions. Long motor cables may require capacitive charging current in excess of the rating of a smaller drive. To assure proper operation, limit smaller drives to the distances listed in Table 2.E , then take the appropriate protection for voltage reflection listed in Table 2.D . When conflicts arise, use the smallest distance listed for a given drive size.

Table 2.E Maximum Cable Length (PWM Frequency = 4 KHZ)

Drive Size Hp	Shielded Cable, 14 AWG 4-Conductor	Multiple Wire Conduit 4-Wire Configuration	Unshielded Cable, 14 AWG 4-Conductor
0.5	45m (150ft)	①	106m (350ft)
0.75	61m (200ft)	①	121m (400ft)
1	68m (225ft)	①	152m (500ft)
2	76m (250ft)	①	167m (550ft)
3	91m (300ft)	①	182m (600ft)
5	152m (500ft)	①	212m (700ft)

① Information not available at time of printing. Estimated length for a given drive size should fall somewhere between the shielded cable value and the unshielded cable value.

IMPORTANT:The cable lengths indicated here are subject to change, consult factory for latest information.

Common Mode Cores

These will help reduce the common mode noise at the drive output and guard against nuisance tripping of the drive caused by capacitive leakage effects. The capacitive currents are larger at higher PWM frequencies.

DRIVE OPERATION WITHOUT A HUMAN INTERFACE MODULE (HIM)

Bulletin 1305 drives are functional without the use of the Human Interface Module (HIM). All control functions can be performed from the control terminal block (TB2). See Figure 2.5 for control descriptions. Programming must be done using a HIM or PLC Remote I/O function. If operating without a HIM, you must use an external Frequency Source on TB2.

Frequency Source

To control frequency from the control terminal block (TB2) an input is required to SW3 at TB2. The input to SW3 changes the frequency source from **[Freq Select 1]** to **[Freq Select 2]**. The factory default setting for **[Freq Select 2]** is the “Remote Pot”.

If a 0-10 Volt or 4-20mA frequency source is required, then the **[Freq Select 1]** or **[Freq Select 2]** parameters must be programmed to select that source. These parameters can be programmed using the optional Human Interface Module or through serial communications when using an optional Bulletin 1203 Communication Module. See Appendix C for Catalog Numbers of these accessories.

Please refer to Chapter 5 for the factory default settings for all parameters. Special attention should be paid to Table 5.A on page 5-27. This table demonstrates what frequency source and accel and decel parameters can be selected based on the inputs to SW1, SW2 and SW3 at TB2.

CONTROL WIRING

IMPORTANT: All common terminals are tied together within the drive.



ATTENTION: Drive can be permanently damaged if any EXTERNAL control voltage is applied to terminals 1 – 8 and 11 – 18. DO NOT connect drive Common terminals (TB2) to ground. DO NOT switch these inputs using non-isolated TTL type circuits. Use dry relay contacts to switch signal inputs to Common. Only isolated 4-20mA sources are recommended. There must be no ground potential difference between source and drive.

The factory default control wire scheme is “3 Wire” control. The **[Input Mode]** parameter can be used to program the drive to operate using a two wire “Run Forward/Run Reverse” control wire scheme. Refer to Chapter 4, Step 10 for programming instructions. Figure 2.5 shows the wiring diagram for the two different modes.

IMPORTANT: If the **[Input Mode]** is changed, power must be cycled to the drive for the change to take effect. The Start and Reverse functions operate differently for the two different input modes.

Three Wire Control

When using this control scheme, the factory default for the reverse function is controlled from TB2. To enable Reverse operation from the HIM or other serial communication adapters, BIT 0 of the **[Direction Mask]** parameter must be changed from “1” to a “0”. See Chapter 5 for general programming instructions. See page 5-43.

Two Wire “Run Forward/Run Reverse” Control

To use a two wire “Run Forward/Run Reverse” control scheme, Bit 0 of the **[Direction Mask]** must be set to a “1.” For proper operation of the “Run Forward/Run Reverse” mode, install a jumper across terminals 7 and 8 (Stop) and terminals 11 and 12 (Enable).

IMPORTANT: The drive can still be started from any adapter (HIM or a serial device) and will run at the last commanded direction unless the start, jog and reverse functions of that adapter have been disabled (See **[Start Mask]**, **[Direction Mask]** and **[Jog Mask]**). See page 5-43 and 5-44.

IMPORTANT: A stop command can be issued from any adapter at all times.

IMPORTANT: If a Jog is initiated, the drive will Jog in the direction last traveled.



ATTENTION: Use of the JOG terminal requires a Bulletin 1201 Human Interface Module or other Device connection to a drive port, otherwise, improper operation will occur with Bulletin 1305 firmware FRN 2.01 or lower.

Figure 2.7 3-Wire Terminal Block (TB2) Designations

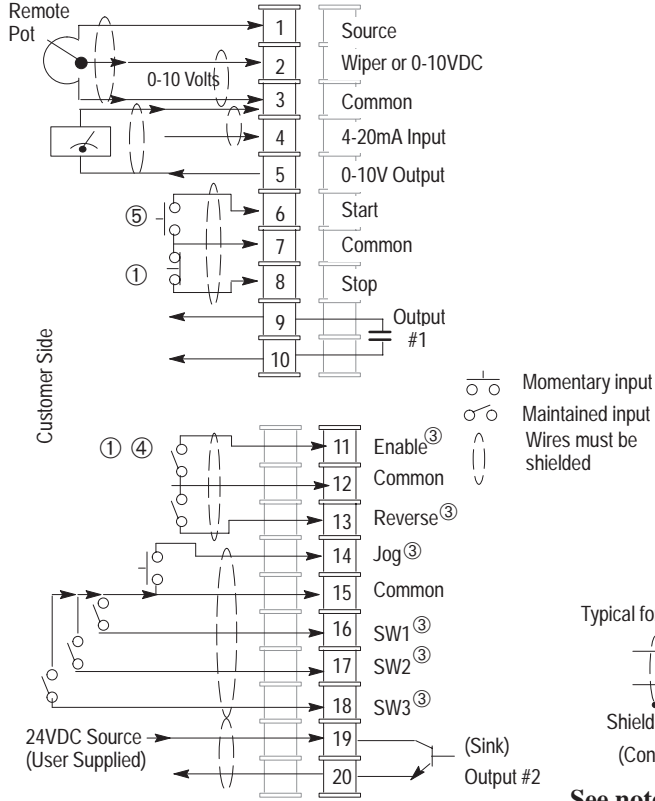
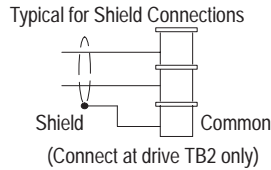
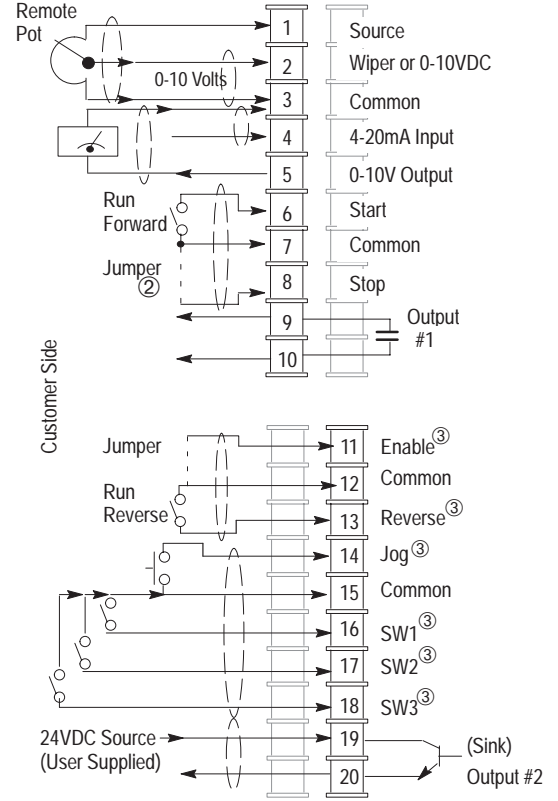


Figure 2.8 Run Fwd/Rev Terminal Block (TB2) Designations



See notes on page 2-18.

Table 2.F Control Terminal Block (TB2) Descriptions^⑥

Terminal No(s)	Signal	Specification
1, 2, 3	External Speed Pot	10 k Ω Potentiometer, 2 Watts
2,3	0-10V Analog Input	Drive Input Impedance = 100 k Ω
4,3	4-20mA Analog Input	Drive Input Impedance = 250 Ω
5, 3	0-10V Analog Output	Meter Impedance \geq 4 k Ω
6, 7	Start	Contact Closure Input ^③
8, 7	Stop	Contact Closure Input ^③
9, 10	Programmable Output 1	Resistive Rating = 115 VAC/30 VDC, 5A Inductive Rating = 115 VAC/30 VDC, 2A
11, 12	Drive Enable	Contact Closure Input ^③
13, 12	Reverse	Contact Closure Input ^③
14, 15	Jog	Contact Closure Input ^③
16, 15	SW1	Contact Closure Input ^③
17, 15	SW2	Contact Closure Input ^③
18, 15	SW3	Contact Closure Input ^③
19, 20	Programmable Output 2	24V DC \pm 20%, 50 mAmps Max. (Sink)

The recommended control signal wire is:

- Belden 8760 (or equiv.) - 18 AWG (0.750 mm²), twisted pair, shielded.
- Belden 8770 (or equiv.) - 18 AWG (0.750 mm²), 3 conductor, shielded.
- Belden 9460 (or equiv.) - 18 AWG (0.750 mm²), twisted pair, shielded.

IMPORTANT: Control inputs to two or more drives should NOT be connected in parallel.

Recommended practice is to run all signal wiring in a separate steel conduit. The shield wire must only be connected at the drive.



ATTENTION: Use of the JOG terminal requires a Bulletin 1201 Human Interface Module or other Device connection to a drive port, otherwise, improper operation will occur with Bulletin 1305 firmware FRN 2.01 or lower.



ATTENTION: Signal common is internally connected to chassis ground. Do not use cable shields as signal current paths.

Notes:

- ① Required to operate drive. Stop also used to clear a fault.
- ② Use HIM Stop button to clear faults.
- ③ Contact Closure Input. Internal 5V supply. DO NOT apply external voltage.
- ④ When the Enable signal is lost, the drive output immediately shuts off and the motor will coast to a stop.
- ⑤ A Start command will override any Jog command.
- ⑥ Control inputs to two or more drives should NOT be connected in parallel.

OUTPUT DEVICES

Drive Output Disconnection



ATTENTION: Any disconnecting means wired to drive output terminals U, V and W must be capable of disabling the drive if opened during drive operation. If opened during drive operation, the drive will continue to produce output voltage between U, V, W. An auxiliary contact must be used to simultaneously disable the drive or output component damage may occur.

CABLE TERMINATION

Optional Cable Terminator

Voltage doubling at motor terminals, known as reflected wave phenomenon, standing wave or transmission line effect, can occur when using drives with long motor cables.

Inverter duty motors with phase-to-phase insulation ratings of 1600 volts or higher should be used to minimize effects of reflected wave on motor insulation life.

Applications with non-inverter duty motors or any motor with exceptionally long leads may require an output inductor or cable terminator. An inductor or terminator will help limit reflection to the motor, to levels which are less than the motor insulation value.

Table 2.D lists the maximum recommended cable length for unterminated cables, since the voltage doubling phenomenon occurs at different lengths for different drive ratings. If your installation requires longer motor cable lengths, a reactor or cable terminator is recommended.

Optional Output Reactor

The reactors listed in Catalog A111 can be used for the drive input and output. These reactors are specifically constructed to accommodate IGBT inverter applications with switching frequencies up to 20 kHz. They have a UL approved dielectric strength of 4000 volts, opposed to a normal rating of 2500 volts. The first two and last two turns of each coil are triple insulated to guard against insulation breakdown resulting from high dv/dt. When using output line reactors, it is recommended that the drive PWM frequency be set to its lowest value to minimize losses in the reactors.

IMPORTANT: By using an output reactor the effective motor voltage will be lower because of the voltage drop across the reactor – this may also mean a reduction of the motor torque.

ADAPTERS

An adapter is any device connected to the drive's serial port. Typical devices include:

- Human Interface Modules
- Communication Modules
- Future adapter devices

IMPORTANT: A maximum of five adapters can communicate to the drive.

The total current draw of all adapters should not exceed 250mA. Refer to the data sheet or nameplate of each adapter for the amount of current needed for the adapter to operate.

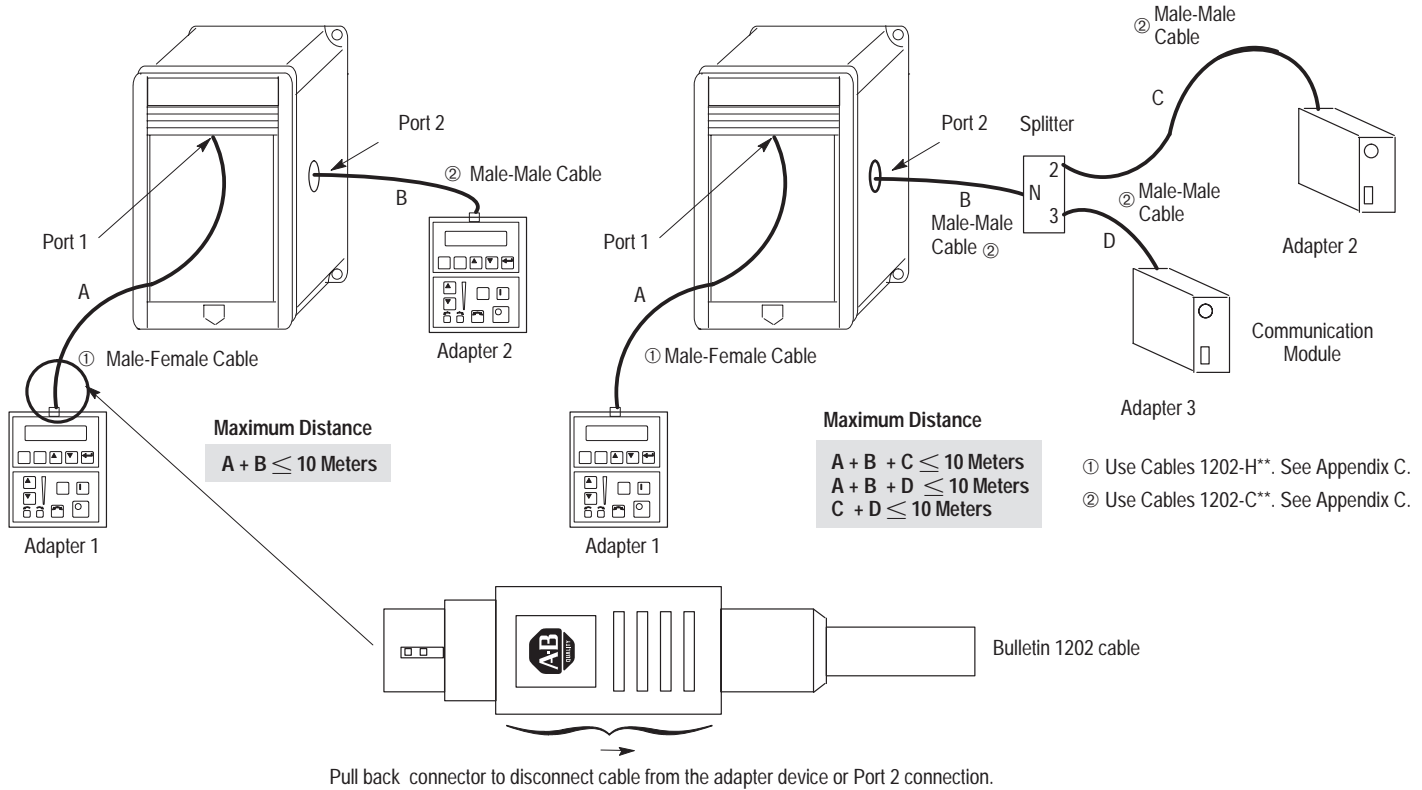
The Adapter address is determined as follows:

- Port 1 equals Adapter 1.
- Port 2 equals Adapter 2. However, if a splitter is used to expand the number of Adapters to 3, 4 or 5 the splitter will be marked with the appropriate Adapter numbers.

Adapter Mounting Distance

The maximum mounting distance between any two adapters connected to the drive is 10 meters. Refer to Figure 2.9.

Figure 2.9 Adapter Mounting Distance and Cable Connections



This Page Intentionally Left Blank.

Chapter Objectives

Chapter 3 describes the various controls and indicators found on the optional Human Interface Module (HIM) of the Bulletin 1305 AC Drive. The material presented in this chapter must be understood to perform the start-up procedure in Chapter 4.

HIM DESCRIPTION

When the drive mounted HIM is supplied, it will be connected as Adapter 1 (see *Adapter* in Chapter 2) and visible from the front of the drive. The HIM can be divided into two sections; Display Panel and Control Panel. The Display Panel provides a means of programming the drive and viewing the various operating parameters. The Control Panel allows different drive functions to be controlled. Refer to Figure 3.1 and the sections that follow for a description of the panels.

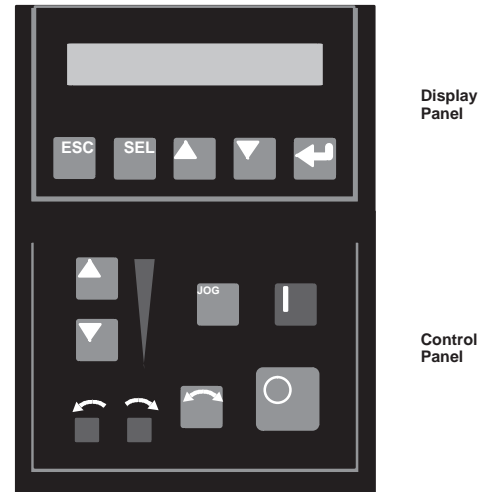
IMPORTANT: The operation of some HIM functions will depend upon drive parameter settings. The default parameter values allow full HIM functionality.

HIM OPERATION

When power is first applied to the drive, the HIM will cycle through a series of displays. These displays will show drive name, HIM ID number and communication status. Upon completion, the Status Display will be shown. This display shows the current status of the drive (i.e. “Stopped,” “Running,” etc.) or any faults that may be present (“Serial Fault,” etc.). If the HIM software is version 3.00 or above (see

back of HIM) the Status Display, Process Display or Password Login menu can be selected as the power-up display or menu. See appropriate sections on the following pages for more information.

Figure 3.1 Human Interface Module



From this display, pressing any one of the five Display Panel keys will cause “Choose Mode” to be displayed. Pressing the Increment or Decrement keys will allow different modes shown in Figure 3.3.

Display Panel Descriptions



Escape

When pressed, the ESC key will cause the programming system to go back one level in the menu structure.



Select

Pressing the SEL key alternately moves the cursor to the next active area. A flashing first character indicates which line is active.



Increment/Decrement

These keys are used to increment and decrement a value or scroll through different groups or parameters.



Enter

When pressed, a group or parameter will be selected or a parameter value will be entered into memory. After a parameter has been entered into memory, the top line of the display will automatically become active, allowing another parameter (or group) to be chosen.

Control Panel Descriptions

IMPORTANT:The following information is correct as shipped from the factory. Reprogramming of mask parameters can mask out control of some of these functions.



Start

The Start key will initiate drive operation if no other control devices are sending a Stop command. This key can be disabled by the **[Logic Mask]** or **[Start Mask]**.



Stop

If the drive is running, pressing the Stop key will cause the drive to stop, using the selected stop mode. Refer to the **[Stop Select]** in Chapter 5.

If the drive has stopped due to a fault, pressing this key will clear the fault and reset the drive. Refer to the **[Flt Clear Mode]**, **[Logic Mask]** and **[Fault Mask]** parameters.



Jog

When pressed, jog will be initiated at the frequency set by the **[Jog Frequency]** parameter, if no other control devices are sending a Stop command. Releasing the key will cause the drive to stop, using the selected stop mode. Refer to **[Stop Select]**, **[Logic Mask]** and **[Jog Mask]**.

IMPORTANT:If the drive is running prior to issuing a jog command, the jog command will be ignored.

Control Panel Descriptions (continued)

**Change Direction**

Pressing this key will cause the drive to ramp down to zero Hertz and then ramp up to set speed in the opposite direction. The appropriate Direction Indicator will illuminate to indicate the direction of motor rotation. Refer to **[Logic Mask]** and **[Direction Mask]**. Note that the factory default for control of the reverse function is the reverse input at the TB2 control terminal block. To enable the HIM control of the reverse function, change Bit 0 of the **[Direction Mask]** parameter to 0 to disable the reverse function at TB2.

**Direction LEDs (Indicators)**

These LEDs illuminate to indicate the direction of motor rotation.

		Rotating "Forward"
		Rotating "Reverse"
		Changing Direction, Decelerating "Reverse", Will Begin to Accelerate "Forward"
		Changing Direction, Decelerating "Forward", Will Begin to Accelerate "Reverse"

**Increment/Decrement Arrows**

(only available with digital speed control)

Pressing these keys will increase or decrease the HIM frequency command. An indication of this command will be shown on the visual Speed Indicator LEDs. The drive will run at this command if the HIM is the selected frequency reference. See **[Freq Select 1/2]**.

Pressing both keys simultaneously stores the current HIM frequency command in HIM memory. The Speed Indicator LED's will flash momentarily to indicate a successful save (if speed is above 20 percent). Cycling power or connecting the HIM to the drive will set the frequency command to the value stored in HIM memory.



If the Analog Speed Potentiometer option has been ordered, the Increment/Decrement keys and Speed Indicator will be replaced by the pot.

**Speed Indicator LEDs**

(only available with digital speed control)

Illuminates in steps to give an approximate visual indication of the commanded speed.

If the Analog Speed Potentiometer option has been ordered, the Increment/Decrement keys and Speed Indicator LEDs will be replaced by the pot.

HIM REMOVAL AND INSTALLATION



ATTENTION: Some voltages present behind the drive front cover are at incoming line potential. To avoid an electric shock hazard, use extreme caution when removing/replacing the HIM.

In addition to mounting directly on the drive, the HIM can be used as a hand held programmer or it can be mounted on the front of an enclosure. The HIM can be removed from the drive in one of two methods:

- A. Disconnect power from the drive and remove the HIM as outlined in steps 1 and 2, or
- B. Remove the HIM from the drive with the drive running, by masking out the **[Logic Mask]** bit that identifies the adapter address of the HIM. Refer to Figure 2.9 to identify the adapter address for the HIM or view the HIM ID# on the display as the unit is powered up. The ID # corresponds to the adapter address. Refer to page 5-42 for programming instructions on the **[Logic Mask]** parameter. For HIM software 3.00 and above, you can enter the Control Status menu and Enable/Disable the Control Logic bit.

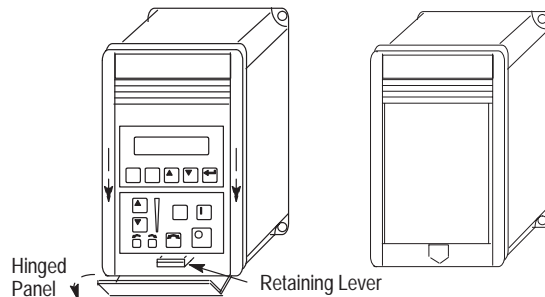
IMPORTANT: If the **[Logic Mask]** bit of the adapter is not masked out (set to 0), and the HIM is removed, a communication fault will occur and the drive will be disabled.

IMPORTANT: If the HIM is removed and it is the active frequency source, the drive will issue a “Hz Error” fault.

IMPORTANT: When the **[Logic Mask]** bit for an adapter is changed from 1 to 0 it disables all command functions for that adapter with the exception of the Stop command and frequency reference.

1. Lower the hinged panel located below the HIM.
2. Press the retaining lever located directly beneath the HIM, slide the HIM downward and remove from the drive.
3. To reinsert the HIM, place the top edge of the HIM about 15 mm (1/2 in.) from the top edge of the cover. Push inward on the bottom of the HIM and slide the HIM up into position.

Figure 3.2 HIM Removal



HIM MODES

The HIM has up to seven different modes. Refer to Figure 3.3.

Display

When selected, the Display mode allows any of the parameters to be viewed. However, parameter modifications are not allowed.

Process

The Process mode allows a “configurable” display to be programmed. One user selected parameter can be displayed with programmed text and scaling. Refer to Chapter 5 for further information.

Program

Program mode provides access to the complete listing of parameters available for programming. Refer to Chapter 5 for further parameter programming information.

EEPROM

This mode allows all parameters to be reset to the factory default settings.

Search *(HIM Software Versions 3.00 and Above Only)*

This mode will search for parameters that are not at their default values.

Control Status *(HIM Software Versions 3.00 and Above Only)*

Permits the **[Logic Mask]** parameter to be disabled/enabled allowing HIM removal while drive power is applied. This menu also provides access to a fault queue which will list the last four faults that have occurred. “Trip” displayed with a fault indicates the actual fault that tripped the drive. A clear function clears the queue.

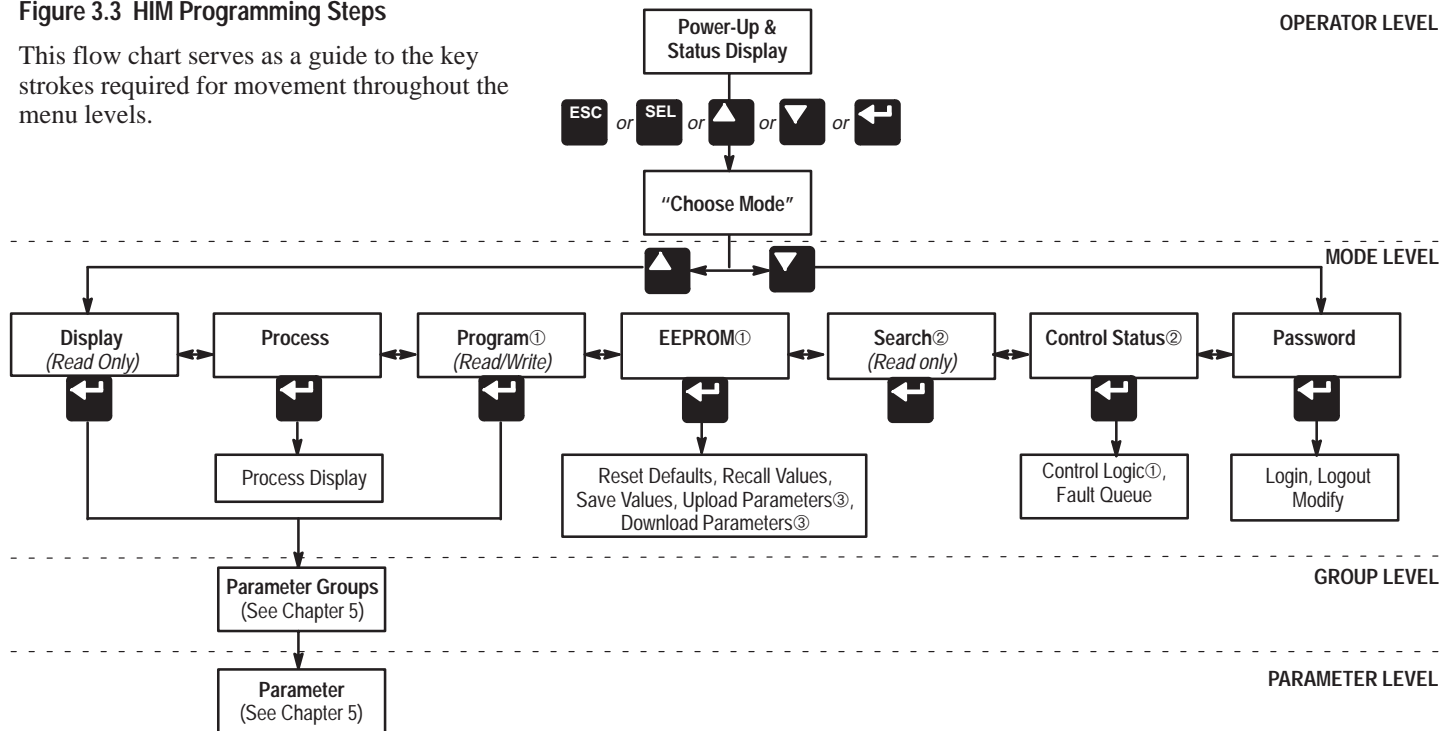
IMPORTANT: Clearing the Fault Queue will not clear an active fault.

Password

The Password mode protects the drive parameters against programming changes by unauthorized personnel. When a password has been assigned, access to the Program and EEPROM modes can only be gained when the correct password has been entered. The password can be any five digit number between 00000 and 65535. Refer to the example on page 3-16.


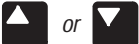

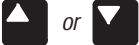

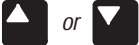


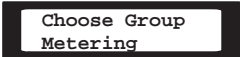

Figure 3.3 HIM Programming Steps

This flow chart serves as a guide to the key strokes required for movement throughout the menu levels.


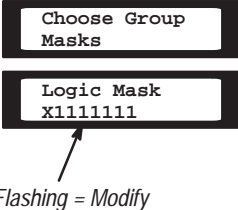


- ① Access to the Program and EEPROM modes, and the Control Logic and Clear Fault Queue, will be disabled if the password is Logged out.
- ② Series A HIM Software Version 3.00 and Above or Series B HIM Software Version 1.01 and Above only.
- ③ Series B HIM Software Version 1.01 and Above only.
























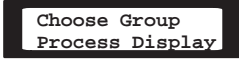
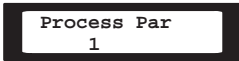
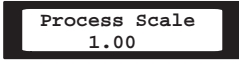

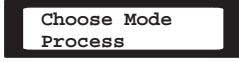

PROGRAM AND DISPLAY MODES

ACTION	DESCRIPTION	HIM DISPLAY
     	<p>□ 1. The Display and Program modes allow access to the parameters for viewing or programming.</p> <p>a. From the Status Display, press Enter (or any key). “Choose Mode” will be shown.</p> <p>b. Press the Increment (or Decrement) key to show “Program” (or “Display”).</p> <p>c. Press Enter.</p> <p>d. Press the Increment (or Decrement) key until the desired group is displayed.</p> <p>e. Press Enter.</p> <p>f. Press the Increment (or Decrement) key to scroll to the desired parameter.</p>	   















PROGRAM AND DISPLAY MODES (cont.)

ACTION	DESCRIPTION	HIM DISPLAY
	<p>With HIM software versions 3.00 and above, you have the ability to access and modify each individual bit or digit..</p> <p>IMPORTANT: This procedure assumes the Password is not set, you have already logged in, or the device has been set to Defaults.</p> <p>g. Select a parameter with Increment (or Decrement) keys.</p> <p>h. Press the SEL key to view the first bit. Pressing this key again will move the cursor to the left one bit or digit.</p> <p>Individual bits of a Read/Write parameter can be changed. Pressing the SEL key will move the cursor (flashing character) one bit to the left. That bit can then be changed by pressing the Increment/Decrement keys. When the cursor is in the far right position, pressing the Increment/Decrement keys will increment or decrement the entire value.</p>	 <p><i>Flashing = Modify</i></p>










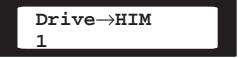

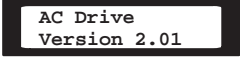


PROCESS MODE

ACTION	DESCRIPTION	HIM DISPLAY
<p>  or   </p> <p>  or   </p> <p>  or   </p> <p>  or   </p> <p>   or  </p> <p>      </p> <p style="text-align: center;"> <i>press</i>   </p>	<p> <input type="checkbox"/> 1. When selected, the Process mode will show a custom display consisting of information programmed with the Process Display group of parameters. </p> <p>a. Complete steps <i>a – c</i> on page 3-7 to access the Program mode.</p> <p>b. Press the Increment/Decrement key until “Process Display” is shown. Press Enter.</p> <p>c. Using the Increment/Decrement keys, select [Process Par] and enter the number of the parameter you wish to monitor. Press Enter.</p> <p>d. Select [Process Scale] using the Increment/Decrement keys. Enter the desired scaling factor. Press Enter.</p> <p>e. Select [Process Text 1] using the Increment/Decrement keys. Enter the desired text character. Press Enter and repeat for the remaining characters.</p> <p>f. When process programming is complete, press ESC until “Choose Mode” is displayed. Press Increment/Decrement until “Process” is displayed. Press Enter to get process value.</p> <p>g. To save Process Display for power up, simultaneously press Increment and Decrement keys (on programming panel).</p>	<p style="text-align: center;"></p> <p style="text-align: center;"></p> <p style="text-align: center;"></p> <p style="text-align: center;"></p> <p style="text-align: center;"></p> <p style="text-align: center;"></p> <p style="text-align: center;"></p>












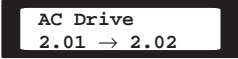


EEPROM MODE

ACTION	DESCRIPTION	HIM DISPLAY
<p>Reset Defaults</p>   or    or    	<p>□ 1. The EEPROM mode is used to restore all settings to factory default values or to upload or download parameters between the HIM and the drive. (Parameter upload or download requires a Series B HIM).</p> <p>To restore factory defaults:</p> <ol style="list-style-type: none"> From the Status Display, press Enter (or any key). “Choose Mode” will be displayed. Press the Increment (or Decrement) key until “EEPROM” is displayed. If EEPROM is not in the menu, programming is password protected. Refer to <i>Password Mode</i> later in this section. Press Enter. Press the Increment (or Decrement) key until “Reset Defaults” is displayed. Press Enter to restore all parameters to their original factory settings. Press ESC. “Reprogram Fault” will display. Press the Stop key to reset the fault. <p>IMPORTANT: If [Input Mode] was previously set to a value other than “1,” cycle drive power to reset.</p>	    








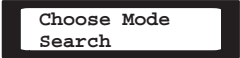
EEPROM MODE (cont.)

ACTION	DESCRIPTION	HIM DISPLAY
<p>Drive → HIM</p> <p> or </p> <p></p> <p>  or </p> <p></p> <p></p>	<p>2. To upload a parameter profile from the drive to the HIM, you must have a Series B HIM.</p> <p>a. From the EEPROM menu, press the Increment/Decrement keys until “Drive → HIM” is displayed.</p> <p>b. Press Enter. Use the Increment/Decrement keys to choose between profile 1 or profile 2.</p> <p>c. To give a profile a name, use the SEL key to move the cursor right and use the Increment/Decrement keys to change the characters. When done, press Enter to save the name.</p> <p>d. Press Enter. An informational display will be shown, indicating the drive type and firmware version.</p> <p>e. Press Enter to start the upload. The parameter number currently being uploaded will be displayed on line 1 of the HIM. Line 2 will indicate total progress. Press ESC to stop the upload.</p> <p>f. A successful upload will be indicated by “Completed” displayed on line 2 of the HIM. Press Enter. If “Error” is displayed, see Chapter 6.</p>	<p></p> <p></p> <p></p> <p></p> <p></p> <p></p>













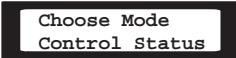
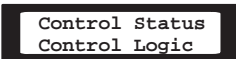

EEPROM MODE (cont.)

ACTION	DESCRIPTION	HIM DISPLAY
<p>HIM → Drive</p> <p> or </p> <p> </p> <p> or </p> <p></p> <p></p> <p></p>	<p>3. To download a parameter profile from the HIM to the drive, you must have a Series B HIM.</p> <p>IMPORTANT: The download function will only be available when there is a valid profile stored in the HIM.</p> <p>a. From the EEPROM menu, press the Increment/Decrement keys until “HIM → Drive” is displayed.</p> <p>b. Press the Enter key. A profile name will be displayed on line 2 of the HIM. Pressing the Increment/Decrement keys will scroll the display to a second profile (if available).</p> <p>c. Once the desired profile name is displayed, press the Enter key. An informational display will be shown, indicating the version numbers of the profile and drive.</p> <p>d. Press Enter to start the download. The parameter number currently being downloaded will be displayed on line 1 of the HIM. Line 2 will indicate total progress. Press ESC to stop the download.</p> <p>e. A successful download will be indicated by “Completed” displayed on line 2 of the HIM. Press Enter. If “Error” is displayed, see Chapter 6.</p>	    













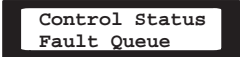
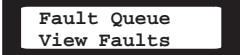
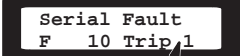
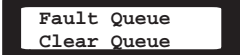
SEARCH MODE

ACTION	DESCRIPTION	HIM DISPLAY
  or    or 	<p>❑ 1. The Search mode is only available with HIM software versions 3.00 and above.</p> <p>This mode allows you to search through the linear parameter list and display all parameters that are not at the factory default values. The Search mode is a read only function..</p> <p>a. From the Status Display, press Enter (or any key). “Choose Mode” will be shown.</p> <p>b. Press the Increment (or Decrement) key until “Search” is displayed.</p> <p>c. Press Enter. The HIM will search through all parameters and display any parameters that are not at their factory default values.</p> <p>d. Press the Increment (or Decrement) key to scroll through the list.</p>	 

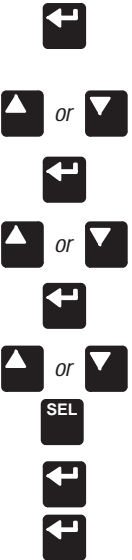
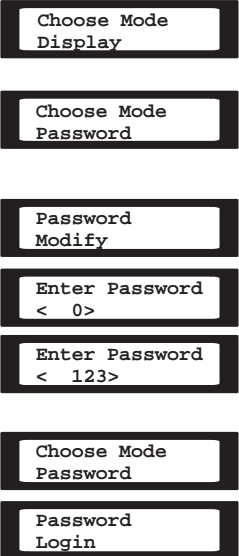
CONTROL STATUS MODE

ACTION	DESCRIPTION	HIM DISPLAY
  or    or     or  	<p>❑ 1. The Control Status mode is only available with HIM software versions 3.00 and above.</p> <p>This mode allows the drive logic mask to be disabled, thus preventing a Serial Fault when the HIM is removed with drive power applied.</p> <ol style="list-style-type: none"> From the Status Display, press Enter (or any key). “Choose Mode” will be shown. Press the Increment (or Decrement) key until “Control Status” is displayed. Press Enter. Select “Control Logic” using the Increment/Decrement keys. Press Enter. Press the SEL key, then use the Increment (or Decrement) key to select “Disabled” (or “Enable”). Press Enter. The logic mask is now disabled (or enabled). 	   

CONTROL STATUS MODE (cont.)











ACTION	DESCRIPTION	HIM DISPLAY
<p>Fault Queue/ Clear Faults</p> <p> or </p> <p></p> <p> or </p> <p></p> <p> or </p> <p>  or </p> <p></p>	<p>2. This menu provides a means to view the fault queue and clear it when desired.</p> <p>f. From the Control Status menu, press the Increment (or Decrement) key until “Fault Queue” is displayed.</p> <p>g. Press Enter.</p> <p>h. Press Increment (or Decrement) key until “View Faults” is displayed.</p> <p>i. Press Enter. The fault queue will be displayed. “Trip” displayed with a fault will indicate the fault that tripped the drive.</p> <p>j. Use the Increment (or Decrement) key to scroll through the list.</p> <p>k. To clear the fault queue, press ESC. Then use the Increment/Decrement keys to select “Clear Queue”. Press Enter.</p> <p>IMPORTANT: Clearing the Fault Queue will not clear an active fault.</p>	<p></p> <p></p> <p></p> <p><i>Buffer Number Location</i></p> <p></p>

PASSWORD MODE

ACTION	DESCRIPTION	HIM DISPLAY
<p>Setting Password</p>  <p>① Login Modify</p>	<p>❑ 1. The factory default password is 0 (which disables password protection). To change the password and enable password protection, perform the following steps.</p> <ol style="list-style-type: none"> From the Status Display, press Enter (or any key). “Choose Mode” will be shown. Press the Increment (or Decrement) key until “Password” is displayed. Press Enter. Press the Increment (or Decrement) key until “Modify” is displayed. Press Enter. “Enter Password” will be displayed. Press the Increment (or Decrement) key to scroll to your desired new password. With HIM software versions 3.00 and up, the SEL key allows each digit to be selected and changed individually. Press Enter to save your new password. Press Enter again to return to the Password Mode. 	








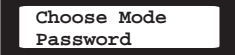

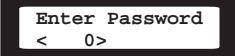
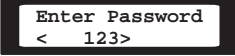

① Login is used to enter the password for access to the Program, Control Logic, Clear Fault Queue, and EEPROM modes.

PASSWORD MODE (cont.)







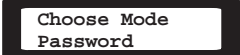



ACTION	DESCRIPTION	HIM DISPLAY
<p>② Logout  or </p> <p></p> <p>Press</p> <p>    </p>	<p>i. Press the Increment (or Decrement) key until “Logout” is displayed.</p> <p>j. Press Enter to log out of the Password mode.</p> <p>k. With HIM software versions 3.00 and up, the Password Login menu can be programmed to appear when drive power is applied. To save the Password Login menu as the power-up menu, simultaneously press the Increment and Decrement keys while the Password display is active.</p>	 

② Logout is used to disable access to the Program, Control Logic, Clear Fault Queue, and EEPROM modes.

PASSWORD MODE (cont.)

ACTION	DESCRIPTION	HIM DISPLAY
<p data-bbox="54 216 239 243">Login to the Drive</p> <div data-bbox="107 298 234 347">  or  </div> <div data-bbox="148 363 193 412">  </div> <div data-bbox="148 429 193 478">  </div> <div data-bbox="107 483 234 532">  or  </div> <div data-bbox="148 603 193 653">  </div>	<p data-bbox="302 221 1156 303">□ 2. The Program and EEPROM modes, and the Clear Fault Queue menu, are now password protected and will not appear in the menu. To access these modes, perform the following steps.</p> <ol data-bbox="371 330 1156 844" style="list-style-type: none"> From the Status Display, press Enter (or any key). “Choose Mode” will be shown. Press the Increment (or Decrement) key until “Password” is displayed. Press Enter. “Login” will be displayed. Press Enter, “Enter Password” will be displayed. Press the Increment (or Decrement) key until your correct password is displayed. With HIM software versions 3.00 and up, the SEL key allows each digit to be selected and changed individually. Press Enter. The Program and EEPROM modes will now be accessible. To prevent future access to program changes, logout as described in step 1. 	<div data-bbox="1230 287 1466 341">  </div> <div data-bbox="1230 352 1466 407">  </div> <div data-bbox="1230 418 1466 472">  </div> <div data-bbox="1230 483 1466 538">  </div> <div data-bbox="1230 592 1466 647">  </div>

PASSWORD MODE (cont.)

ACTION	DESCRIPTION	HIM DISPLAY
<p>Logout from the Drive</p> <p>  or    or   </p>	<p>□ 3. To prevent unauthorized changes to parameters, Logout must be performed as described below.</p> <p>a. From the Status Display, press Enter (or any key). “Choose Mode” will be shown.</p> <p>b. Press the Increment (or Decrement) key until “Password” is displayed.</p> <p>c. Press Enter.</p> <p>d. Press the Increment (or Decrement) key until “Logout” is displayed.</p> <p>e. Press Enter to log out of the Password mode.</p>	   

This Page Intentionally Left Blank.

CHAPTER OBJECTIVES

This chapter describes the steps needed to start-up the drive. Included in the procedure are typical adjustments and checks to assure proper operation. The information contained in previous chapters of this manual must be read and understood before proceeding.

IMPORTANT: The drive is designed so that start-up is simple and efficient. The programmable parameters are grouped logically so that most start-ups can be accomplished by adjusting parameters in only one group. Advanced features and adjustments are grouped separately. This eliminates having to step through unneeded parameters on initial start-up.

This start-up procedure covers only those most commonly adjusted values, all of which appear in the Setup Group.

START-UP PROCEDURE

The following start-up procedure is written for users who have a Human Interface Module (HIM) installed. For users without a HIM, external commands and signals must be substituted.

IMPORTANT: The parameters in the Set Up Group (page 5-8) should be reviewed and reprogrammed as necessary for basic operation.



ATTENTION: Power must be applied to the drive to perform the following start-up procedure. Some of the voltages present are at incoming line potential. To avoid electric shock hazard or damage to equipment, only qualified service personnel should perform the following procedure. Thoroughly read and understand the procedure before beginning. If an event does not occur while performing this procedure, **Do Not Proceed. Remove Power** by opening the branch circuit disconnect device and correct the malfunction before continuing.

IMPORTANT:

- Power must be applied to the drive when viewing or changing parameters. Previous programming may effect the drive status when power is applied.
- Confirm that all circuits are in a de-energized state before applying power. User supplied voltages may exist at TB2 even when power is not applied to the drive.
- Refer to Chapter 6 for fault code information.

Initial Operation - Motor Disconnected


- ❑ 1. Verify that AC line power at the disconnect device is within the rated value of the drive.
- ❑ 2. Disconnect and lock-out all incoming power to the drive including incoming AC power to terminals L1, L2 and L3 (R, S and T) plus any separate control power for remote interface devices. Remove the drive cover and verify the motor leads are disconnected from the Power Terminal Block (TB1), terminals T1, T2 and T3 (U, V, W). Refer to Chapter 2 for terminal location.

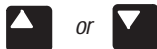


ATTENTION: Proceed with caution. A DC Bus Voltage may be present at the Power Terminal Block (TB1) even when power is removed from the drive.

- ❑ 3. Verify that the Stop and Enable inputs are present.
- ❑ 4. Confirm that all other optional inputs are connected to the correct terminals and are secure.
- ❑ 5. If the HIM has a Control Panel, use the local controls to complete the start-up procedure. If a Control Panel is not present, remote devices must be used to operate the drive.
- ❑ 6. Replace the drive cover.

ACTION	DESCRIPTION	HIM DISPLAY
<p>Apply Power to Drive</p>	<p>❑ 7. When power is first applied to the drive, the following information will be momentarily displayed:</p> <ul style="list-style-type: none"> a.) The HIM ID# (Adapter #) and firmware version number. b.) Communication status. c.) Series letter of drive is displayed. d.) The LCD Display should light and display a drive status of “Stopped” and an output frequency of “+0.00 Hz.” 	

	<p><input type="checkbox"/> 8. If the HIM and drive are not communicating properly, “Connection Fail” may be displayed on line 2. If this occurs remove the HIM from the drive and reinsert. See Page 3-4 for HIM Removal instructions. If this does not correct the problem or another fault message is displayed, record the information and remove all power. Determine and correct the fault source before proceeding. Refer to Chapter 6 for fault descriptions.</p>	
Reset Factory Defaults	<p><input type="checkbox"/> 9. IMPORTANT: The remaining steps in this procedure are based on factory default parameter settings. If the drive has been previously operated, parameter settings may have been changed and may not be compatible with this start-up procedure or application. Refer to page 3-9 to reset to factory defaults.</p>	
[Input Mode] Selection	<p><input type="checkbox"/> 10. The factory default [Input Mode] is “3 wire” control as described in Chapter 2. If the factory default setting is sufficient, then skip to Step 11. If a “Run Fwd/Rev” control scheme is desired, change the [Input Mode] parameter by performing the following procedure.</p>	



□ 10. INPUT MODE SELECTION (continued)

- a.) From the Status Display, press the Enter key (or any key). “Choose Mode” will be displayed.
- b.) Press the Increment (or Decrement) key until “Program” is displayed.
- c.) Press Enter. The parameter group “Metering” will be displayed.
- d.) Press the Increment key again until the “Set Up” Group is displayed.
- e.) Press Enter.
- f.) Press the Increment or Decrement key until the **[Input Mode]** parameter is displayed.
- g.) Press SEL. The first character of line 2 will now flash.
- h.) Press the Increment or Decrement key until the correct mode is displayed, then press enter. The first character of line 1 should now be flashing.
- i.) Press the ESC key (3 times) to return to the Status Display.

IMPORTANT: If the **[Input Mode]** is changed, power must be cycled for the change to take effect.

Choose Mode
Display

Choose Mode
Program

Choose Group
Metering

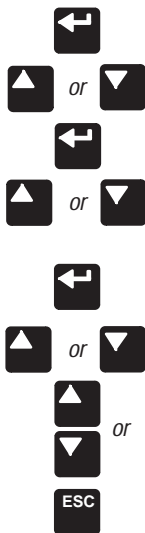
Choose Group
Set Up

Input Mode
3 Wire

Input Mode
3 Wire

Input Mode
Run Fwd/Rev

Stopped
+0.00 Hz



□ 11. Setting Frequency Command to 0 Hz

If the HIM has an analog potentiometer option, turn the potentiometer fully counter clockwise and skip to Step 12.

If the HIM has Digital Up-Down keys for frequency control then perform the following:

- a.) From the Status Display, press the Enter key (or any key). “Choose Mode” will be displayed.
- b.) Press the Increment or Decrement key until “Display” is shown.
- c.) Press Enter.
- d.) Press the Increment or Decrement key again until “Metering” is displayed.
- e.) Press Enter.
- f.) Press the Increment or Decrement key until [Freq Command] is displayed.
- g.) If the frequency command is a value other than 0 Hz, use the speed source (digital up-down keys on Control Panel) to set the command to 0 Hz.
- h.) After the command has been set to 0 Hz, press the ESC key until the Status Display is shown.

Choose Mode
Program

Choose Mode
DISPLAY

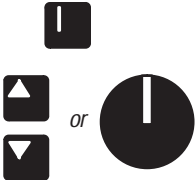
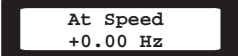
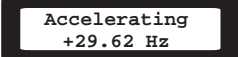
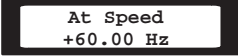

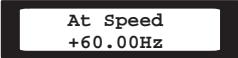
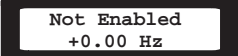
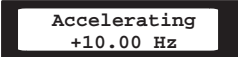
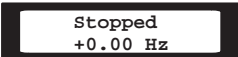
Choose Group
Set Up


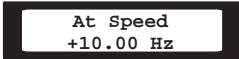






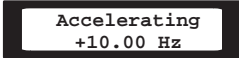
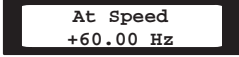
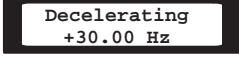

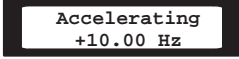
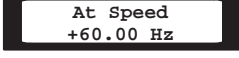
Choose Group
Metering

Output Current
0.00 Amps

Freq Command
+0.00 Hz

Stopped
+0.00 Hz

	<p><input type="checkbox"/> 12. Verifying Minimum and Maximum Frequency Settings.</p> <p>a.) Press the Start key. The drive should output zero Hz, which is the factory default value for the [Minimum Freq] parameter. The Status Display should indicate “At Speed” and the actual frequency (+0.00 Hz.).</p> <p>b.) With the drive still running, use the speed source to command maximum speed. The drive should ramp to 60 Hz, which is the factory default value for the [Maximum Freq] parameter.</p>	  
<p>Open Enable Signal Restore Enable Signal</p> 	<p><input type="checkbox"/> 13. Enable interlock check.</p> <p>The following steps check for correct drive operation when the Enable input is removed. Refer to Chapter 2 for terminal designations.</p> <p>a.) With the drive still running, open the Enable signal. The drive should stop and indicate “Not Enabled” on the Display Panel. Restore the Enable signal.</p> <p>b.) Restart the drive by pressing the Start key.</p> <p>c.) Stop the drive.</p>	   

<p>Press & Hold Jog Key</p>  <p>Release Jog Key</p>	<p><input type="checkbox"/> 14. Jog Control Check.</p> <p>a.) With the drive stopped, press and hold the Jog key on the Control Panel. The drive should accelerate to the frequency programmed by the [Jog Frequency] parameter and remain there until the JOG key is released. When released, the drive should “Ramp to Stop” which is the factory default stopping method for the [Stop Select] parameter.</p>	 
<p>Set to Maximum Frequency</p>  <p>or</p>    	<p><input type="checkbox"/> 15. Checking Accel and Decel Times.</p> <p>a.) Start the drive and use the speed source to command maximum frequency.</p> <p>b.) Press the Stop key and estimate the amount of time the drive takes to decelerate from 60 Hz to zero. This time should equal the time set in the [Decel Time 1] parameter (default is 10 seconds). If these times are not correct for your application, refer to Chapter 5 for instructions on programming changes.</p> <p>c.) Start the drive and estimate the amount of time the drive takes to accelerate to maximum frequency. This should equal 10 seconds, which is the factory default value for the [Accel Time 1] parameter.</p> <p>d.) Stop the drive.</p>	     



ATTENTION: Proceed with caution. A DC Bus Voltage may be present at the Power Terminal Block (TB1) even when power is removed from the drive.

Remove ALL Power

Reconnect Motor




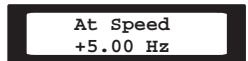
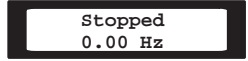
16. Reconnect the Motor.

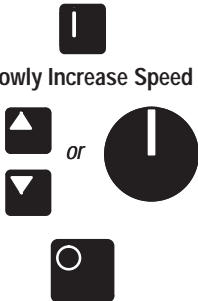
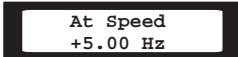
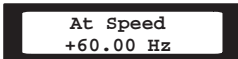

- a.) Disconnect and lock-out all input and control power to the drive. When the HIM Display is no longer illuminated, remove the drive cover.
- b.) Verify that the DC Bus neon indicator is not illuminated (Refer to Figure 2.3 for location). Reconnect the motor leads to the drive and replace the drive cover.

IMPORTANT:The parameters in the Set Up Group (page 5-8) should be reviewed and reprogrammed as necessary for basic operation.



ATTENTION: In the following steps, rotation of the motor in an un-desired direction can occur. To guard against possible equipment damage, it is recommended that the motor be disconnected from the load before proceeding.

<p>Apply Power to Drive</p> <p>Verify Frequency Command = 0</p>  <p>Slowly Increase Speed</p>  <p>Verify Direction of Rotation</p> 	<p>□ 17. Check for Correct Motor Rotation.</p> <p>a.) Reapply power to the drive.</p> <p>b.) Verify that the frequency command is at 0 Hz. Refer to step 11 for further information.</p> <p>c.) Start the drive.</p> <p>d.) <i>Slowly</i> increase the speed until the motor begins to turn. Check the direction of motor rotation.</p> <p>e.) Stop the drive. If the direction of rotation is as desired, proceed to step 18.</p> <p>If the direction of rotation is incorrect - disconnect and lock-out all input and control power to the drive. When the HIM Display is no longer illuminated, remove the drive cover. Verify that the DC Bus neon indicator is not illuminated (refer to Figure 2.3 for location) and wait 60 seconds. Interchange any two of the three motor leads at TB1 terminals, T1, T2 or T3. Replace the drive cover and repeat steps <i>a – e</i> to verify correct motor rotation.</p>	 
--	--	--

 <p>Slowly Increase Speed</p>	<p><input type="checkbox"/> 18. Check for proper operation.</p> <p>a.) Start the drive.</p> <p>b.) <i>Slowly</i> increase the speed. Check for proper motor operation throughout the speed range.</p> <p>c.) Press the Stop key.</p>	  
	<p><input type="checkbox"/> 19. This completes the basic start-up procedure. Depending on your application, further parameter programming may be required. Refer to Chapter 5 for information.</p> <p>IMPORTANT:The parameters in the Set Up Group (page 5-8) should be reviewed and reprogrammed as necessary for basic operation.</p>	

CHAPTER OBJECTIVES

Chapter 5 describes all parameters for Bulletin 1305 drives. Parameters are divided into groups for ease of programming and operator access. Grouping replaces a sequentially numerical parameter list with functional parameter groups that increases operator efficiency and helps to reduce programming time. For most applications, this means simplicity at startup with minimum drive tuning.

CHAPTER CONVENTIONS

1. All parameters required for any given drive function will be contained within a group, eliminating the need to change groups to complete a function.
2. To help differentiate parameter names and display text from other text in this manual, the following conventions will be used – Parameter Names will appear in **[Brackets]** – Display Text will appear in “Quotes.”
3. Parameter information in this chapter is presented for users who have a Human Interface Module (HIM) installed. For those users without a HIM installed, the drive can be operated using the factory default values for each parameter or parameter values can be changed through the serial port.

FUNCTION INDEX

The Function Index shown provides a directory of various drive functions. The Page Number will direct you to the parameters associated with each function.

Function	Page #	Function	Page #
Accel/Decel Time	5-8	MOP	5-6, 5-28,
Accel/Decel Selection	5-25		5-44, 5-48
Analog Invert	5-20	Motor Unbalance	5-32
Auto Restart/	5-29	Output Configuration	5-33
Run On Power Up		Overload Protection	5-12
Current Limiting	5-11, 5-13	Preset Frequencies	5-23, 5-25, 5-26
Custom Volts/Hz	5-16	Process Display	5-51
DC Boost	5-16, 5-17,	PWM Freq. Derating	5-19
	5-18	Ramp to Stop	5-19
DC Brake-to-Stop	5-21, 5-22	S-Curve Acceleration	5-21,
Fan/Pump Volts/Hz	5-17	Skip Frequencies	5-25, 5-25
Fault Buffer History	5-35	Standard Boost V/Hz	5-17
Frequency Select	5-25, 5-23	Standard Volts/Hz	5-17
Freq. Source Selection	5-25	Start/Run Boost	5-15
Line Loss Fault	5-35		
Minimum/Maximum Freq.	5-10		

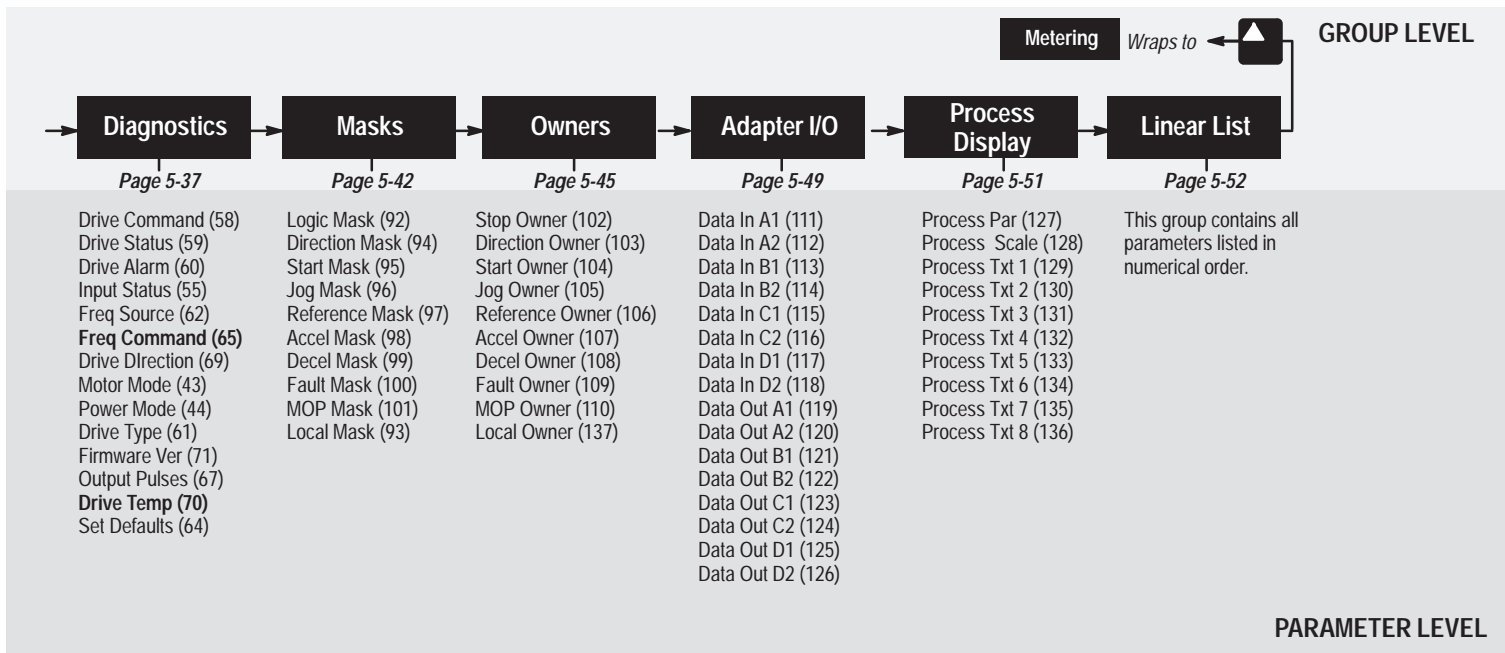
PARAMETER FLOW CHART

The chart provided on pages 5-2 and 5-3 highlights each group of parameters and lists all parameters for each of the 13 groups. Parameters that appear in more than one group are shown in bold. Parameter numbers are shown in parenthesis immediately after the parameter name. An example of how to program a parameter is shown on page 5-4.

PARAMETER FLOW CHART


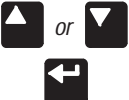
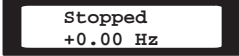




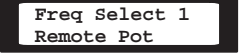
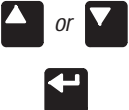
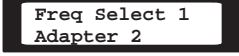
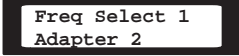
Wrap to Linear List						
Metering	Set Up	Advanced Setup	Frequency Set	Feature Select	Output Configuration	Faults
Page 5-5	Page 5-8	Page 5-14	Page 5-23	Page 5-29	Page 5-33	Page 5-35
Output Current (54) Output Voltage (1) Output Power (23) DC Bus Voltage (53) Output Freq (66) Freq Command (65) MOP Hz (42) Drive Temp (70) Last Fault (4) % Output Power (3) % Output Curr (2)	Input Mode (21) Freq Select 1 (5) Accel Time 1 (7) Decel Time 1 (8) Base Frequency (17) Base Voltage (18) Maximum Voltage (20) Minimum Freq (16) Maximum Freq (19) Stop Select (10) Current Limit (36) Overload Mode (37) Overload Current (38) Sec Curr Limit (141)	Minimum Freq (16) Maximum Freq (19) Base Frequency (17) Base Voltage (18) Break Frequency (49) Break Voltage (50) Maximum Voltage (20) DC Boost Select (9) Start Boost (48) Run Boost (83) PWM Frequency (45) Analog Invert (84) 4-20 mA Loss Sel (81) Stop Select (10) DC Hold Time (12) DC Hold Level (13) DB Enable (11) Motor Type (41) Compensation (52)	Freq Select 1 (5) Freq Select 2 (6) Jog Freq (24) Prst/2nd Accel (26) Upper Presets (72) Accel Time 2 (30) Decel Time 2 (31) Preset Freq 1 (27) Preset Freq 2 (28) Preset Freq 3 (29) Preset Freq 4 (73) Preset Freq 5 (74) Preset Freq 6 (75) Preset Freq 7 (76) Skip Freq 1 (32) Skip Freq 2 (33) Skip Freq 3 (34) Skip Freq Band (35) MOP Increment (22)	Run On Power Up (14) Reset/Run Tries (85) Reset/Run Time (15) S Curve Enable (57) S Curve Time (56) Language (47) Balance Freq (80) Balance Time (79) Balance Angle (78)	Output 1 Config (90) Output 2 Config (91) Analog Out Sel (25) Above Freq Val (77) Above Curr Value (142)	Fault Buffer 0 (86) Fault Buffer 1 (87) Fault Buffer 2 (88) Fault Buffer 3 (89) Clear Fault (51) Cur Lim Trip En (82) Line Loss Fault (40) Flt Clear Mode (39)

Bold indicates parameters located in more than one group.



PROGRAMMING EXAMPLE

The following is an example of the programming steps required to change a parameter setting. In this example, the parameter **[Freq Select 1]** is being programmed from its' factory default setting of "Adapter 1" to a new setting, "Adapter 2".

ACTION	DESCRIPTION	HIM DISPLAY
 To Select Mode 	<input type="checkbox"/> 1. Press any key to go from the Status Display to the "Choose Mode" menu. <input type="checkbox"/> 2. Press the Up/Down keys until "Program" appears on the display. <input type="checkbox"/> 3. Press the Enter key to go to the "Program" menu.	 
To Select a Group 	<input type="checkbox"/> 4. Press the Up/Down keys until "Setup" appears on the display. <input type="checkbox"/> 5. Press the Enter key to go to the "Setup" menu.	
To Select a Parameter within a Group 	<input type="checkbox"/> 6. Press the Up/Down keys until [Freq Select 1] appears on the display. <input type="checkbox"/> 7. Press the SEL key. The first character of line 2 will flash indicating the parameter setting/value can be changed.	
To Change a Parameter Setting or Enter a Value 	<input type="checkbox"/> 8. Press the Up/Down keys until "Adapter 2" appears on the display. <input type="checkbox"/> 9. Press the Enter key to program [Freq Select 1] to "Adapter 2."	 

Metering

This group of parameters consists of commonly viewed drive operating conditions such as drive output frequency, output voltage, output current and command frequency. All parameters in this group are Read Only.

[Output Current]

This parameter displays the output current present at TB1, terminals T1, T2 & T3 (U, V & W).

Parameter #	54	Factory Default	None
Parameter Type	Read Only	Minimum	0.00
Units	.01 Amps	Maximum	Two Times Drive Output Current

[Output Voltage]

This parameter displays the output voltage present at TB1, terminals T1, T2 & T3 (U, V & W)

Parameter #	1	Factory Default	None
Parameter Type	Read Only	Minimum	0
Units	1 Volt	Maximum	Maximum Voltage

[Output Power]

This parameter displays the output power present at TB1, terminals T1, T2, & T3 (U, V & W).

Parameter #	23	Factory Default	None
Parameter Type	Read Only	Minimum	0
Units	.01 kW	Maximum	Two Times Rated Drive Output Power

[DC Bus Voltage]

This parameter displays the DC bus voltage level.

Parameter #	53	Factory Default	None
Parameter Type	Read Only	Minimum	0.00
Units	1 Volt	Maximum	410 - 230V Drive 815 - 460V Drive

Metering Group (cont.)

[Output Freq]	Parameter # 66 Parameter Type Read Only Units 0.01 Hz	Factory Default None Minimum – [Maximum Freq] Maximum + [Maximum Freq]
This parameter displays the output frequency present at TB1, terminals T1, T2 & T3 (U, V & W).		
[Freq Command]	Parameter # 65 Parameter Type Read Only Units 0.01 Hz	Factory Default 0.00 Hz Minimum 0.00 Hz Maximum +400.00 Hz
This parameter displays the frequency that the drive is commanded to output. This command may come from any one of the frequency sources selected by [Freq Select 1] , [Freq Select 2] or [Preset Freq 1-7] the preset speeds 1-7 as determined by the inputs to SW1, SW2, and SW3 at TB2.		
[MOP Hz]	Parameter # 42 Parameter Type Read Only Units 0.01 Hz	Factory Default None Minimum 0.00 Hz Maximum 400.00 Hz
This parameter displays the frequency reference commanded by the MOP function through serial communication. This value is displayed regardless of whether or not this is the active frequency command.		

Metering Group (cont.)

<p>[Drive Temp]</p> <p>This parameter displays the drive internal temperature.</p>	<p>Parameter # 70</p> <p>Parameter Type Read Only</p> <p>Units 1°C</p>	<p>Factory Default None</p> <p>Minimum 0</p> <p>Maximum Not Applicable</p>
<p>[Last Fault]</p> <p>This parameter displays the fault code for the present drive fault. If there is no active fault, the value will be zero.</p>	<p>Parameter # 4</p> <p>Parameter Type Read Only</p> <p>Units Numeric</p>	<p>Factory Default None</p> <p>Minimum 0</p> <p>Maximum Max. Fault Number</p>
<p>[% Output Power]</p> <p>This parameter displays the percent of drive rated output power.</p>	<p>Parameter # 3</p> <p>Parameter Type Read Only</p> <p>Units 1 %</p>	<p>Factory Default None</p> <p>Minimum 0 %</p> <p>Maximum 200% Drive Rated Power</p>
<p>[% Output Curr]</p> <p>This parameter displays the percent of drive rated output current.</p>	<p>Parameter # 2</p> <p>Parameter Type Read Only</p> <p>Units 1 %</p>	<p>Factory Default None</p> <p>Minimum 0 %</p> <p>Maximum 200% of Rated Drive Output Current</p>

Set Up

This group of parameters defines the basic operation of the drive and should be programmed before initial operation. For advanced programming and information on specific parameters, refer to the flow chart on page 5-2 & 5-3

[Input Mode]

This parameter selects between three wire and Run Fwd/Rev control. Refer to Chapter 2, Figure 2-5.

IMPORTANT: If this parameter is changed while the drive is operating, power must be cycled to the drive for the change to take effect. This is required since the start and reverse functions will operate differently for the two different modes.

Parameter #	21	Factory Default	"3 wire"	
Parameter Type	Read & Write	Setting	"3 Wire"	
Units	None		"Run Fwd/Rev"	

IMPORTANT: This parameter cannot be programmed while the drive is running.

[Freq Select 1]

This parameter is the factory default parameter for selecting the frequency source that will supply the **[Freq Command]** to the drive. **[Freq Select 2]** or **[Preset Freq 1-7]** can be selected in place of this parameter with proper terminal block inputs. (See Charts on Pages 5-26 and 5-27).

Parameter #	5	Factory Default	"Adapter 1"	
Parameter Type	Read & Write	Settings	"Remote Pot"	"Preset 1"
			"0-10 Volt"	"Preset 2"
Units	None		"4-20 mA"	"Preset 3"
			"MOP"	"Preset 4"
			"Adapter 1"	"Preset 5"
			"Adapter 2"	"Preset 6"
			"Adapter 3"	"Preset 7"
			"Adapter 4"	
			"Adapter 5"	
			"Adapter 6"	

[Accel Time 1]

This parameter is the factory default parameter for determining the time it will take the drive to ramp from 0 Hz to **[Maximum Frequency]**. The rate is linear unless **[S Curve]** is "Enabled." It applies to any increase in command frequency. The **[Accel Time 2]** parameter can be selected in place of this parameter. (See Charts on Pages 5-26 and 5-27).

Parameter #	7	Factory Default	10.0 Sec	
Parameter Type	Read & Write	Minimum	0.0 Sec	
Units	0.1 Second	Maximum	3600.0 Sec	

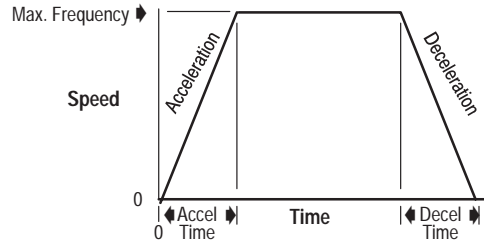
Set Up Group (cont.)

[Decel Time 1]

This parameter is the factory default parameter for determining the time it will take the drive to ramp from **[Maximum Frequency]** to 0 Hz. The rate is linear unless **[S Curve]** is “Enabled” or **[Stop Select]** is set to “S-Curve.” It applies to any decrease in command frequency. The **[Decel Time 2]** parameter can be selected in place of this parameter. (See Chart on Page 5-26).

Parameter #	8	Factory Default	10.0 Sec
Parameter Type	Read & Write	Minimum	0.0 Sec
Units	0.1 Second	Maximum	3600.0 Sec

Figure 5.1 Accel/Decel Time

**[Base Frequency]**

This value should be set to the motor nameplate Rated Frequency.

Parameter #	17	Factory Default	60 Hz
Parameter Type	Read & Write	Minimum	40 Hz
Units	1 Hz	Maximum	400 Hz

[Base Voltage]

This value should be set to the motor nameplate Rated Voltage.

Parameter #	18	Factory Default	Max. Drive Rated Volts
Parameter Type	Read & Write	Minimum	25% of Max. Drive Rated Volts
Units	1 Volt	Maximum	100% of Max. Drive Rated Volts

Set Up Group (cont.)

<p>[Maximum Voltage]</p> <p>This parameter sets the highest voltage the drive will output. IMPORTANT: [Maximum Voltage] must be greater than or equal to [Base Voltage].</p>	<p>Parameter # 20</p> <p>Parameter Type Read & Write</p> <p>Units 1 Volt</p>	<p>Factory Default</p> <p>Minimum</p> <p>Maximum</p>	<p>Max. Drive Rated Volts</p> <p>25% of Max. Drive Rated Voltage</p> <p>100% of Max. Drive Rated Volts</p>
<p>[Minimum Freq]</p> <p>This parameter sets the lowest frequency the drive will output. IMPORTANT: All analog inputs to the drive (4-20mA, 0-10V, Remote Pot) are scaled for the range [Minimum Freq] to [Maximum Freq].</p>	<p>Parameter # 16</p> <p>Parameter Type Read & Write</p> <p>Units 1 Hz</p>	<p>Factory Default</p> <p>Minimum</p> <p>Maximum</p>	<p>0 Hz</p> <p>0 Hz</p> <p>120 Hz</p> <p>IMPORTANT: This parameter can not be programmed while the drive is running.</p>
<p>[Maximum Freq]</p> <p>This parameter sets the highest frequency the drive will output. IMPORTANT: All analog inputs to the drive (4-20mA, 0-10V, Remote Pot) are scaled for the range [Minimum Freq] to [Maximum Freq].</p>	<p>Parameter # 19</p> <p>Parameter Type Read & Write</p> <p>Units 1 Hz</p>	<p>Factory Default</p> <p>Minimum</p> <p>Maximum</p>	<p>60 Hz</p> <p>40 Hz</p> <p>400 Hz</p> <p>IMPORTANT: This parameter can not be programmed while the drive is running.</p>

Set Up Group (cont.)

<p>[Stop Select]</p> <p>This parameter selects the stopping mode when the drive receives a valid stop command.</p>	<p>Parameter # 10</p> <p>Parameter Type Read & Write</p> <p>Units None</p>	<p>Factory Default "Ramp"</p> <p>Settings "Coast"</p> <p>"Ramp"</p> <p>"DC Brake"</p> <p>"S-Curve"</p>	<p><i>Causes the Drive to Turn Off Immediately</i></p> <p><i>Drive Decelerates to 0 Hz, Then Turns Off – Requires a Value In [Decel Time 1] or [Decel Time 2]</i></p> <p><i>Injects DC Braking Voltage Into the Motor – Requires a Value in Both [Decel Hold Time] & [Decel Hold Level].</i></p> <p><i>Drive ramps to stop using 'fixed S-Curve' profile. Stop time is twice the selected decel time.</i></p>
<p>[Current Limit]</p> <p>This parameter sets the maximum drive output current that is allowed before current limiting occurs. IMPORTANT: If a value is programmed into the [Sec Curr Limit] parameter then that value will be the active current limit value at speeds above 1.5 times [Base Frequency]. See Fig. 5.5. [Output 1 Config] and [Output 2 Config] can be set to "alarm" to indicate an overload condition exists.</p>	<p>Parameter # 36</p> <p>Parameter Type Read & Write</p> <p>Units 1 %</p>	<p>Factory Default 150 % of Drive Rated Current ①</p> <p>Minimum 20 % of Drive Rated Current ①</p> <p>Maximum 150% of Drive Rated Current ①</p>	<p>IMPORTANT: See [Cur Lim Trip En] on page 5-35.</p>

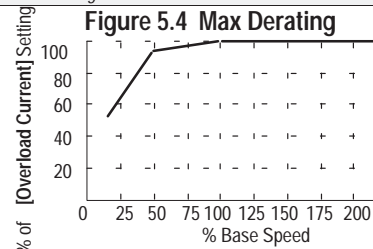
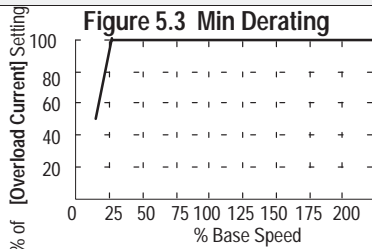
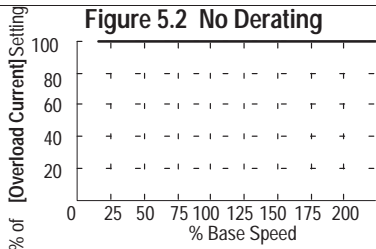
① The Drive Rated Output Current is based on three phase input ratings. See page 5-13 for instructions for **Single Phase Input Ratings**.

Set Up Group (cont.)

[Overload Mode]

This parameter selects the derating factor for the I²t electronic overload function. Designed to meet NEC Article 430 and UL (file E59272) equivalent requirements. Additional overload devices do not need to be installed.

Parameter #	37	Factory Default	"No Derating"	
Parameter Type	Read & Write			
Units	None	Settings	"No Derating"	10:1 Speed Range – No Derating Refer to Figure 5.2
			"Min Derate"	4:1 Speed Range – Derate below 25% of Base Speed. Refer to Figure 5.3
			"Max Derate"	2:1 Speed Range – Derate below 50% of Base Speed. Refer to Figure 5.4



[Overload Current]

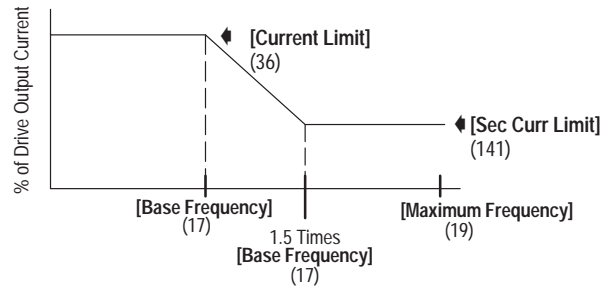
This value should be set to the motor nameplate Full Load Amps (F.L.A.).

Parameter #	38	Factory Default	115% of Drive Rated Current	<i>Displayed in Amps</i>
Parameter Type	Read & Write	Minimum	20% of Drive Rated Current	<i>Displayed in Amps</i>
Units	0.1 Amps	Maximum	115% of Drive Rated Current	<i>Displayed in Amps</i>

[Sec Curr Limit]	Parameter #	141	Factory Default	0% of Drive Rated Current ②
	Parameter Type	Read & Write	Minimum	0% of Drive Rated Current ②
	Units	1%	Maximum	150% of Drive Rated Current ②

When this parameter is set to zero, the **[Current Limit]** setting is used throughout the frequency range. When set to a value other than zero, the **[Current Limit]** value will be active up to the **[Base Frequency]** setting, then tapers down between **[Base Frequency]** and 1.5 times **[Base Frequency]**. At frequencies above 1.5 times **[Base Frequency]**, the **[Sec Curr Limit]** setting is the active current limit value.

Figure 5.5 Current Limit Setting



Single Phase Input Ratings

The **[Current Limit]**, **[Overload Current]** and **[Sec Curr Limit]** parameters are set based on the drive rated output current for three phase input ratings. When setting these parameters for single phase input ratings, use the following formula to determine the proper parameter setting:

$$\frac{1\emptyset \text{ Output Current}^{\textcircled{3}} \times \text{Percent (0 to 150\%)}}{3\emptyset \text{ Output Current}^{\textcircled{3}}} = \text{Parameter setting in percent}$$

- ② The Drive Rated Output Current is based on three phase input ratings. See **Single Phase Input Ratings** instructions.
- ③ See Table 1.A on page 1-6.

Advanced Setup

This group contains parameters that are required to setup advanced functions of the drive such as custom Volts per Hertz settings and dynamic braking.

[Minimum Freq]

This parameter sets the lowest frequency the drive will output. **IMPORTANT:** All analog inputs to the drive (4-20mA, 0-10V, Remote Pot) are scaled for the range **[Minimum Freq]** to **[Maximum Freq]**.

Parameter #	16	Factory Default	0 Hz
Parameter Type	Read & Write	Minimum	0 Hz
Units	1 Hz	Maximum	120 Hz

IMPORTANT: This parameter can not be programmed while the drive is running.

[Maximum Freq]

This parameter sets the highest frequency the drive will output. **IMPORTANT:** All analog inputs to the drive (4-20mA, 0-10V, Remote Pot) are scaled for the range **[Minimum Freq]** to **[Maximum Freq]**.

Parameter #	19	Factory Default	60 Hz
Parameter Type	Read & Write	Minimum	40 Hz
Units	1 Hz	Maximum	400 Hz

IMPORTANT: This parameter can not be programmed while the drive is running.

[Base Frequency]

This value should be set to the motor nameplate Rated Frequency.

Parameter #	17	Factory Default	60 Hz
Parameter Type	Read & Write	Minimum	40 Hz
Units	1 Hz	Maximum	400 Hz
Units	1 Hz	Maximum	400 Hz

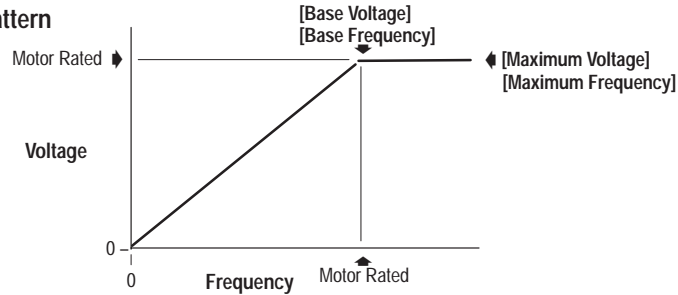
Advanced Set Up Group (cont.)

[Base Voltage]

This value should be set to the motor nameplate Rated Voltage.

Parameter #	18	Factory Default	Max. Drive Rated Volts
Parameter Type	Read & Write	Minimum	25% of Max. Drive Rated Volts
Units	1 Volt	Maximum	100% of Max. Drive Rated Volts

Figure 5.6 Standard Volts-per-Hz Pattern

**[Break Frequency]**

This parameter sets a midpoint frequency on a custom Volts-per-Hz curve. Combined with **[Break Voltage]**, this value determines the Volts-per-Hz ratio between 0 and **[Break Frequency]**. Note: **[DC Boost Select]** must be set to "Break Point" for this parameter to be active.

Parameter #	49	Factory Default	0 Hz
Parameter Type	Read & Write	Minimum	0 Hz
Units	1 Hz	Maximum	120 Hz

Advanced Set Up Group (cont.)

[Break Voltage]

This parameter sets the voltage the drive will output at **[Break Frequency]**. Combined with **[Break Frequency]**, this value determines the Volts-per-Hz ratio between 0 and **[Break Frequency]**. **IMPORTANT: [DC Boost Select]** must be set to "Break Point" for this parameter to be active.

Parameter #	50	Factory Default	0 Volts
Parameter Type	Read & Write	Minimum	0 Volts
Units	1 Volt	Maximum	50% of Max. Drive Rated Volts

[Maximum Voltage]

This parameter sets the highest voltage the drive will output.

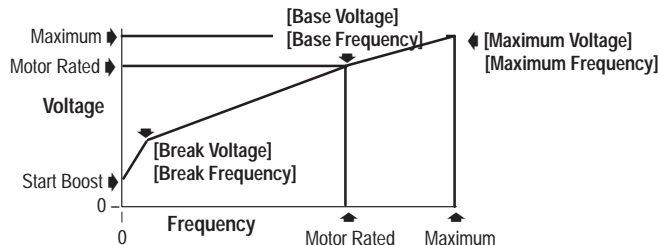
Parameter #	20	Factory Default	Max. Drive Rated Volts
Parameter Type	Read & Write	Minimum	25% of Max. Drive Rated Volts
Units	1 Volt	Maximum	100% of Max. Drive Rated Volts

Figure 5.7 Custom Volts-per-Hz Pattern

This pattern is active only when **[DC Boost Select]** is set to "Break Point."

The following guidelines should be followed when setting up a custom Volts-per-Hz curve:

1. **[Maximum Voltage]** must be greater than **[Base Voltage]**.
2. **[Base Voltage]** must be greater than **[Start Boost]**.
3. If **[DC Boost Select]** is set to "Break Point" then:
 - [Base Voltage]** must be greater than **[Break Voltage]** and
 - [Break Voltage]** must be greater than **[Start Boost]**.



Advanced Set Up Group (cont.)

[DC Boost Select]

This parameter sets the level of DC boost at low frequencies. It also selects special volts-per-Hz patterns.

Parameter #	9	Factory Default	"No Boost"	
Parameter Type	Read & Write			
Units	None	Settings	"No Boost"	See Figure 5.8
			"6 Volts"	See Figure 5.8
			"12 Volts"	See Figure 5.8
			"18 Volts"	See Figure 5.8
			"24 Volts"	See Figure 5.8
			"30 Volts"	See Figure 5.8
			"36 Volts"	See Figure 5.8
			"42 Volts"	See Figure 5.8
			"48 Volts"	See Figure 5.8
			"Break Point"	See Figure 5.7
			"Run Boost"	See Figure 5.10
			"Fan Sel #1"	See Figure 5.9
			"Fan Sel #2"	See Figure 5.9

Figure 5.8 Standard Boost Volts-per-Hz Pattern

Active when [DC Boost Select] is set to "No Boost" or "6 Volts" through "48 Volts."

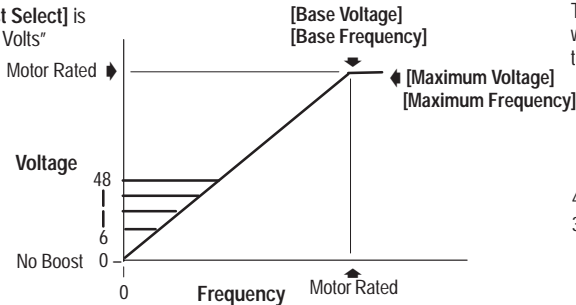
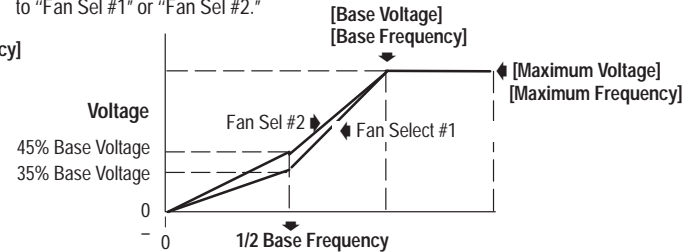


Figure 5.9 Fan/Pump Volts-per-Hz Pattern

These patterns are active only when [DC Boost Select] is set to "Fan Sel #1" or "Fan Sel #2."



Advanced Set Up Group (cont.)

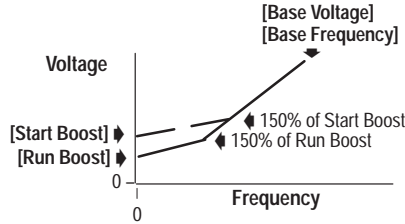
[Start Boost]

This parameter sets the DC boost level for acceleration when [DC Boost Select] is set to "Run Boost" or "Break Point."

Parameter #	48	Factory Default	0 Volts
Parameter Type	Read & Write	Minimum	0 Volts
Units	1 Volt	Maximum	25% of Max. Drive Rated Volts

Figure 5.10 Start/Run Boost

Active when [DC Boost Select] is set to "Run Boost"



[Run Boost]

This parameter sets the DC boost level for constant speed level when [DC Boost Select] is set to "Run Boost." [Run Boost] must be set at a value less than [Start Boost].

Parameter #	83	Factory Default	0 Volts
Parameter Type	Read & Write	Minimum	0 Volts
Units	1 Volt	Maximum	25% of Max. Drive Rated Volts

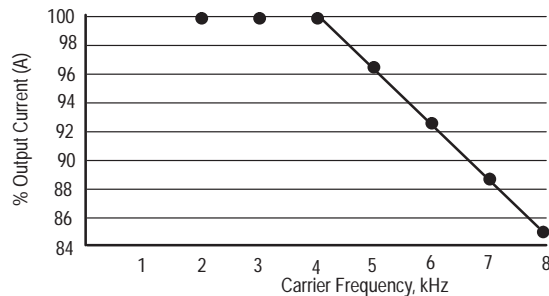
[PWM Frequency]

Parameter #	45	Factory Default	4.0 kHz
Parameter Type	Read & Write	Minimum	2.0 kHz
Units	0.1 kHz	Maximum	8.0 kHz

This parameter sets the carrier frequency for the PWM output waveform. **IMPORTANT:** Output Current derating applies above 4kHz. See Fig. 5-11.

Figure 5.11 PWM Frequency Derating

IMPORTANT: Ignoring derating guidelines can cause reduced drive performance.



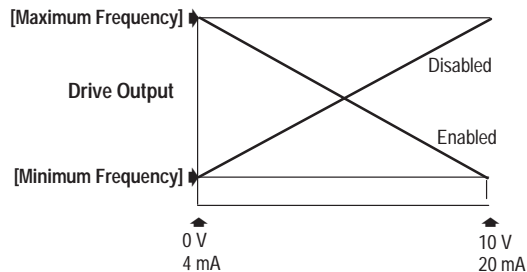
Advanced Set Up Group (cont.)

[Analog Invert]

This parameter enables the inverting function for the 0-10 Volt and 4-20mA analog input signal at TB2.

Parameter #	84	Factory Default	"Disabled"
Parameter Type	Read & Write	Settings	"Enabled"
Units	None		"Disabled"
			<i>Maximum Input Commands [Minimum Freq]</i>
			<i>Minimum Input Commands [Maximum Freq]</i>
			<i>Maximum Input Commands [Maximum Freq]</i>
			<i>Minimum Input Commands [Minimum Freq]</i>

Figure 5.12 Analog Invert



[4-20mA Loss Sel]

This parameter selects the drives reaction to a loss of a 4-20mA signal when the active [Frequency Source] is 4-20mA. **IMPORTANT:** The drive output contacts can be used to issue an alarm signal by setting [Output 1 Config] or [Output 2 Config] to "alarm".

Parameter #	81	Factory Default	"Stop/Fault"
Parameter Type	Read & Write	Settings	"Stop/Fault"
Units	None		"Hold/Alarm"
			"Max/Alarm"
			"Pre1/Alarm"
			"Min/Alarm"
			<i>Drive Stops and Issues "Hz Err Fault" (F29)</i>
			<i>Drive Maintains Last Output Freq and sets an Alarm bit</i>
			<i>Drive Outputs [Maximum Freq] and sets Alarm bit</i>
			<i>Drive Outputs [Preset Freq 1] and sets an Alarm bit</i>
			<i>Drive Outputs [Minimum Freq] and sets an Alarm bit</i>

Advanced Set Up Group (cont.)

<p>[Stop Select]</p> <p>This parameter selects the stopping mode when the drive receives a valid stop command.</p>	Parameter #	10	Factory Default	"Ramp"	
	Parameter Type	Read & Write			
	Units	None	Settings	"Coast"	<i>Causes the Drive to Turn Off Immediately</i>
				"Ramp"	<i>Drive Decelerates to 0 Hz, Then Turns Off – Requires a Value In [Decel Time 1] or [Decel Time 2]</i>
				"DC Brake"	<i>Injects DC Braking Voltage Into the Motor – Requires a Value in Both [Decel Hold Time] & [Decel Hold Level].</i>
			"S-Curve"	<i>Drive ramps to stop using a fixed "S-Curve" profile. Stop time is twice the selected decel time.</i>	

<p>[DC Hold Time]</p> <p>This value sets the amount of time that the [DC Hold Level] voltage will be applied to the motor when the stop mode is set to either "DC Brake" or "Ramp." When in "Coast " mode and the drive is stopped and restarted within the [DC Hold Time] setting, the speed will resume at the output frequency prior to the stop command.</p>	Parameter #	12	Factory Default	0 Sec
	Parameter Type	Read & Write	Minimum	0 Sec
	Units	1 Second	Maximum	15 Sec

Figure 5.13 Ramp

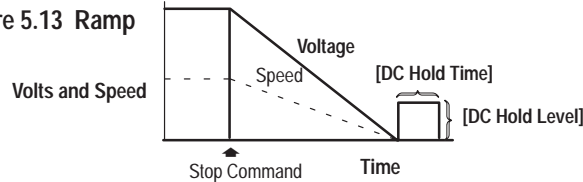
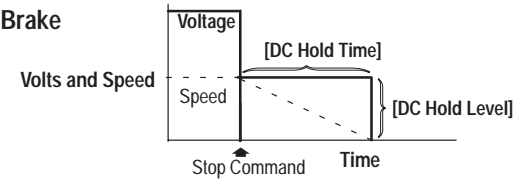


Figure 5.14 DC Brake



Advanced Set Up Group (cont.)

[DC Hold Level]

This parameter value sets the DC voltage applied to the motor during braking when the **[Stop Select]** is set to either “DC Brake” or “Ramp”. **IMPORTANT:** When setting this parameter, begin at a low voltage and continue increasing until sufficient holding torque is achieved and the drive output current rating is not exceeded.

Parameter #	13	Factory Default	0 Volts
Parameter Type	Read & Write	Minimum	0 Volts
Units	1 Volt	Maximum	25% of Max. Drive Rated Volts

[DB Enable]

This parameter enables the use of external dynamic brake resistors. **IMPORTANT:** Dynamic braking is not available for 1/2 through 1HP (0.37 to 0.75 kW) units rated 230 Volt.

Parameter #	11	Factory Default	“Disabled”
Parameter Type	Read & Write	Settings	“Enabled” <i>Permits dynamic brake operation</i>
Units	None		“Disabled” <i>Permits Ramp Regulation</i>

[Motor Type]

This parameter should be set to match the type of motor connected to the drive.

Parameter #	41	Factory Default	“Induc/Reluc”
Parameter Type	Read & Write	Settings	“Induc/Reluc” <i>Requires No Additional Setting for use with induction/reluctance rated motors</i>
Units	None		“Sync PM” <i>Requires [Stop Select] to be set to a selection other than “DC Brake” when used with Synchronous Permanent Magnet Motors</i>

[Compensation]

Some drive/motor combinations have inherent instabilities which are exhibited as nonsinusoidal current feedback. The compensation when enabled will correct this condition. Compensation is only active at frequencies below 50 Hertz where the problem is most pronounced.

Parameter #	52	Factory Default	“No Comp”
Parameter Type	Read & Write	Settings	“No Comp” Compensation Disabled
Units	None		“Comp” Compensation Enabled

Frequency Set

This group of parameters allows the user to program the frequency source, frequency settings, accel/decel times and skip frequencies of the drive.

[Freq Select 1]

This parameter is the factory default parameter for selecting the frequency source that will supply the [Freq Command] to the drive. [Freq Select 2] or [Preset Freq 1-7] can be selected in place of this parameter with proper terminal block inputs. Refer to charts on Pages 5-26 and 5-27.

Parameter #	5	Factory Default	"Adapter 1"	
Parameter Type	Read & Write			
Units	None	Settings	"Remote Pot"	"Preset 1"
			"0-10 Volt"	"Preset 2"
			"4-20 mA"	"Preset 3"
			"MOP"	"Preset 4"
			"Adapter 1"	"Preset 5"
			"Adapter 2"	"Preset 6"
			"Adapter 3"	"Preset 7"
			"Adapter 4"	
			"Adapter 5"	
			"Adapter 6"	

[Freq Select 2]

This parameter controls which of the frequency sources is currently supplying the [Freq Command] to the drive unless [Freq Select 1] or [Preset Freq 1-7] are selected with proper terminal block inputs. Refer to charts on Pages 5-26 and 5-27.

Parameter #	6	Factory Default	"Remote Pot"	
Parameter Type	Read & Write			
Units	None	Settings	"Remote Pot"	"Preset 1"
			"0-10 Volt"	"Preset 2"
			"4-20 mA"	"Preset 3"
			"MOP"	"Preset 4"
			"Adapter 1"	"Preset 5"
			"Adapter 2"	"Preset 6"
			"Adapter 3"	"Preset 7"
			"Adapter 4"	
			"Adapter 5"	
			"Adapter 6"	

Frequency Set Group (cont.)**[Jog Frequency]**

This parameter sets the frequency the drive will output when it receives a jog command.

Parameter #	24	Factory Default	10.0 Hz
Parameter Type	Read & Write	Minimum	0.0 Hz
Units	0.1 Hz	Maximum	400.0 Hz

[Prst/2nd Accel]

This parameter, along with the **[Upper Presets]** parameter, determines which frequency source and Accel/Decel parameters will be selected using the optional inputs SW1, SW2 and SW3. Refer to charts on Pages 5-26 and 5-27.

Parameter #	26	Factory Default	"Preset"
Parameter Type	Read & Write	Settings	"Preset" "2nd Accel"
Units	None		

[Upper Presets]

This parameter along with the **[Prst/2nd Accel]** parameter determines which frequency source and Accel/Decel parameters will be selected using the optional inputs SW1, SW2 and SW3. Refer to charts on Pages 5-26 and 5-27.

Parameter #	72	Factory Default	"Disabled"
Parameter Type	Read & Write	Settings	"Enabled" "Disabled"
Units	None		

[Accel Time 2]

This value determines the time it will take the drive to ramp from 0 Hz to **[Maximum Frequency]**. The rate is linear unless **[S Curve]** is "Enabled." It applies to any increase in command frequency unless **[Accel Time 1]** is selected. Refer to charts on Pages 5-26 and 5-27.

Parameter #	30	Factory Default	10.0 Sec
Parameter Type	Read & Write	Minimum	0.0 Sec
Units	0.1 Second	Maximum	3600.0 Sec

Frequency Set Group (cont.)

[Decel Time 2]	Parameter #	31	Factory Default	10.0 Sec
	Parameter Type	Read & Write	Minimum	0.0 Sec
	Units	0.1 Second	Maximum	3600.0 Sec
	This value determines the time it will take the drive to ramp from [Maximum Freq] to 0 Hz. The rate is linear unless [S Curve] is "Enabled" or [Stop Select] is set to "S-Curve." It applies to any decrease in command frequency unless [Decel Time 1] is selected. Refer to charts on Pages 5-26 and 5-27.			
[Preset Freq 1-7]	Parameter #	27-29 & 73-76	Factory Default	0.0 Hz
	Parameter Type	Read & Write	Minimum	0.0 Hz
	Units	0.1 Hz	Maximum	400.0 Hz
	These values set the frequencies that the drive will output when selected. Refer to charts on Pages 5-26 and 5-27.			
[Skip Freq 1-3]	Parameter #	32-34	Factory Default	400 Hz
	Parameter Type	Read & Write	Minimum	0 Hz
	Units	1 Hz	Maximum	400 Hz
	These values, in conjunction with [Skip Freq Band] , create a range of frequencies at which the drive will not operate continuously.			

Programming the drive for Frequency Source and Accel/Decel Control

Use NO TAG and NO TAG to determine which frequency source and Accel/Decel Time are suitable to your application. Switch or contact inputs at terminal TB2 are used to select functionality based on how you program parameters (26) and (72).

Table 5.A Frequency Source Selection

Parameter Settings		Frequency Source ①									Control Terminal Block			Accel/Decel	
Preset/ 2nd Accel(26)	Upper Presets (72)	Freq Select1 (5)	Freq Select2 (6)	Preset Freq 1 (27)	Preset Freq 2 (28)	Preset Freq 3 (29)	Preset Freq 4 (73)	Preset Freq 5 (74)	Preset Freq 6 (75)	Preset Freq 7 (76)	SW3 TB2-18	SW2 TB2-17	SW1 TB2-16		
Preset ②	Disabled ②	•									0	0	0	When you set parameter 26 to "Preset," only Accel Time 1 and Decel Time 1 can be used.	
				•							0	0	X		
					•							0	X		0
						•						0	X		X
			•									X	0		0
				•								X	0		X
					•							X	X		0
					•						X	X	X		
		Enabled	•									0	0		0
					•							0	0		X
						•						0	X		0
							•					0	X		X
								•				X	0		0
										•		X	0		X
										•	X	X	0		
										•	X	X	X		

① The parameter [Freq Source] indicates the active frequency source. See p. 5-40.

• Indicates active function/parameter.

X Indicates closed switch.

② Factory default settings.

0 Indicates open switch.

(26) Indicates parameter number.

Table 5.B Accel/Decel Selection

Parameter Settings		Frequency Source ①									Accel/Decel				Control Terminal Block			
Preset/ 2nd Accel(26)	Upper Presets (72)	Freq Select 1 (5)	Freq Select 2 (6)	Preset Freq 1 (27)	Preset Freq 2 (28)	Preset Freq 3 (29)	Preset Freq 4 (73)	Preset Freq 5 (74)	Preset Freq 6 (75)	Preset Freq 7 (76)	Accel Time 1 (7)	Decel Time 1 (8)	Accel Time 2 (30)	Decel Time 2 (31)	SW3 TB2-18	SW2 TB2-17	SW1 TB2-16	
2nd Accel	Disabled ②	•									•	•			0	0	0	
		•										•	•		0	0	X	
		•										•		•	0	X	0	
		•											•	•	0	X	X	
			•									•	•			X	0	0
				•									•	•		X	0	X
					•								•		•	X	X	0
	Enabled		•									•	•			0	0	0
			•										•	•		0	0	X
			•									•			•	0	X	0
			•											•	•	0	X	X
								•				•	•			X	0	0
								•					•	•		X	0	X
								•				•			•	X	X	0
						•						•	•	X	X	X		

① The parameter [Freq Source] indicates the active frequency source. See p. 5-40.

• Indicates active function/parameter.

X Indicates closed switch.

② Factory default settings.

0 Indicates open switch.

(26) Indicates parameter number.

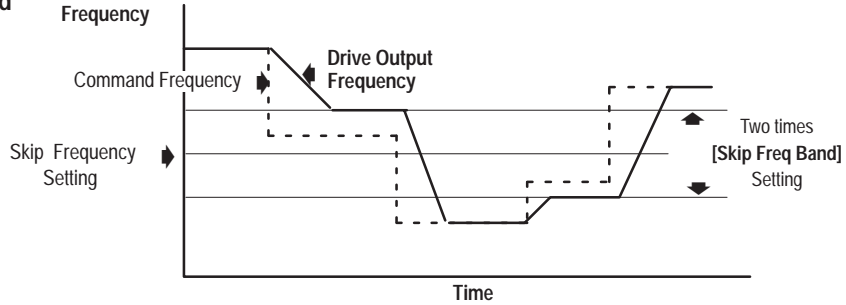
Frequency Set Group (cont.)

[Skip Freq Band]

This parameter determines the band width around a [Skip Frequency]. The actual band width is $2 \times$ [Skip Freq Band] – 1/2 the band above and 1/2 the band below the [Skip Frequency] setting. “0” Disables All Skip Frequencies.

Parameter #	35	Factory Default	0 Hz
Parameter Type	Read & Write	Minimum	0 Hz
Units	1 Hz	Maximum	15 Hz

Figure 5.15 Skip Frequency Band



[MOP Increment]

This parameter sets the rate of increase or decrease to the [MOP Hertz] command frequency. **IMPORTANT:** The MOP function can only be invoked through a serial communications module.

Parameter #	22	Factory Default	0.00 Hz/Sec
Parameter Type	Read & Write	Minimum	0.00
Units	1 Hz/Sec	Maximum	255 Hz/Sec

Feature
Select

This group contains the necessary parameters to activate and program advanced features of the drive.

[Run On Power Up]

This parameter enables the function that allows the drive to **automatically restart** on power up regardless of what the drive status was before power is lost. This applies only when there is a maintained input to the start and stop inputs. Refer to Chapter 2, Figure 2.5.

Parameter #	14	Factory Default	"Disabled"
Parameter Type	Read & Write		
Units	None	Settings	"Enabled" "Disabled"



ATTENTION: This parameter may only be used as outlined in NFPA 79, paragraph 6-14 (exceptions 1-3) for specialized applications. Equipment damage and/or personal injury may result if this parameter is used in an inappropriate application.

[Reset/Run Tries]

This value sets the maximum number of times the drive attempts to reset a fault and restart before the drive issues a "Max Retries Fault." Not operative for faults 9, 10, 11, 24, 25, 26, 29, 30, 32, 33, 34, 35, 38, 39, 40, 41, 42, 43 and 48.

Parameter #	85	Factory Default	0
Parameter Type	Read & Write	Minimum	0
Units	None	Maximum	9

[Reset/Run Time]

This value sets the time between restart attempts when **[Reset/Run Tries]** is a value other than 0.

Parameter #	15	Factory Default	1.0 Sec
Parameter Type	Read & Write	Minimum	0.5 Sec
Units	0.1 Second	Maximum	30.0 Sec

Feature Select Group (cont.)

[S Curve Enable]

This parameter enables a fixed shape S-Curve.

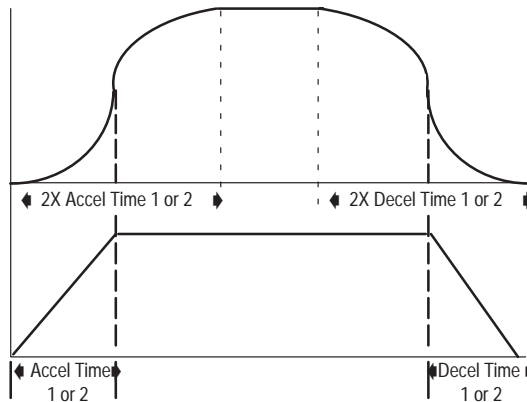
Parameter #	57	Factory Default	"Disabled"
Parameter Type	Read & Write		
Units	None	Settings	"Enabled" "Disabled"

Figure 5.16 S-Curve

Accel/Decel times are double the active accel/decel time settings.

IMPORTANT: The setting for [S-Curve Time] must be 0.

IMPORTANT: If [Stop Select] is set to "S Curve" then the decel time will be double the active decel setting when a stop command is provided.



Enabled

Disabled

Feature Select Group (cont.)

[S Curve Time]

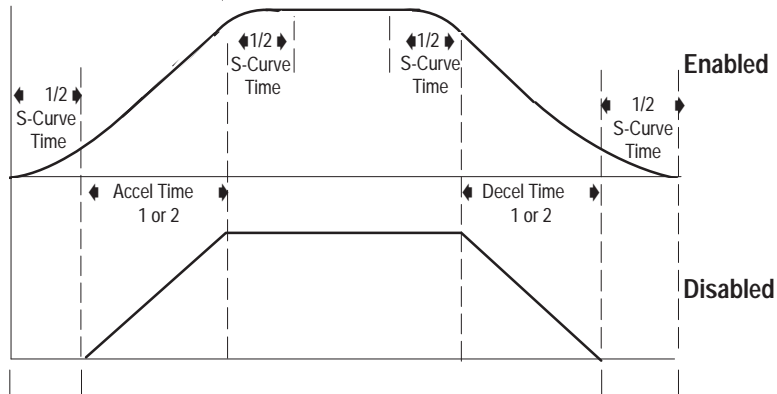
Parameter #	56	Factory Default	0.0 Sec
Parameter Type	Read & Write	Minimum	0.0 Sec
Units	0.1 Second	Maximum	300.0 Sec

This parameter enables an adjustable shape S-Curve accel/decel time. **IMPORTANT: [S-Curve Time]** must be set to a value less than or equal to the Accel & Decel times.

Figure 5.17 S-Curve Time

[S-Curve Enable] must be “enabled” for this parameter to be active. The [S-Curve Time] setting is added to the active accel/decel times to form an adjustable S-Curve.

IMPORTANT: If [Stop Select] is set to “S Curve” then the decel time will be double the active decel setting when a stop command is provided.



[Language]

Parameter #	47	Factory Default	“English”
Parameter Type	Read & Write	Settings	“English” or “French” “Italian” “Japanese” “Spanish” “German”
Units	None		

This parameter selects between English and the alternate second language that can be displayed on the HIM.

Feature Select Group (cont.)

[Balance Freq]

This parameter selects the frequency at which balance detection is performed.

Parameter #	80	Factory Default	0 Hz
Parameter Type	Read & Write	Minimum	0 Hz
Units	1 Hertz	Maximum	255 Hz

[Balance Time]

This parameter determines the amount of delay time before a valid output occurs. The delay time begins when the drive reaches [Balance Freq]. The output contact will be closed when balanced and open when unbalanced.

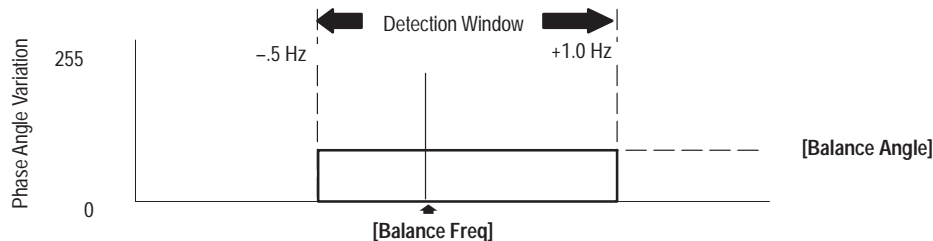
Parameter #	79	Factory Default	0 Sec
Parameter Type	Read & Write	Minimum	0 Sec
Units	0.1 second	Maximum	255 Sec

[Balance Angle]

This parameter determines the acceptable variation in phase angle which is set between a balanced condition and an unbalanced condition. A balance condition is defined as a variation which is less than the 'Balance Angle' setting. [Output 1 Config] or [Output 2 Config] can be set to "Balance" to indicate when a balanced condition exists.

Parameter #	78	Factory Default	0
Parameter Type	Read & Write	Minimum	0
		Maximum	255

Figure 5.18 Motor Unbalance



Output Configuration

This group of parameters contains the programming options for digital and analog drive outputs.

[Output 1 Config]

This parameter sets the condition that actuates the relay output at TB2, terminals 9 and 10.

Parameter #	90	Factory Default	"Faulted"
Parameter Type	Read & Write		
Units	None	Settings	"At Speed" <i>Output closes when drive reaches [Freq Command]</i> "Above Freq" <i>Output closes when drive exceeds value set in [Above Freq Val].</i> "Running" <i>Output closes when drive is running</i> "Faulted" <i>Output closes when drive is faulted</i> "Alarm" <i>Output closes when the drive reaches hardware current limit, software current limit, overvoltage, line loss or 4-20 mA loss.</i> "Balanced" <i>Output closes when a balance condition is detected.</i> "Above Curr" <i>Output closes when current exceeds value set in [Above Curr Val].</i>

[Output 2 Config]

This parameter sets the condition that actuates the open collector output at TB2, terminals 19 and 20.

Parameter #	91	Factory Default	"Running"
Parameter Type	Read & Write		
Units	None	Settings	"At Speed" <i>Output closes when drive reaches [Freq Command]</i> "Above Freq" <i>Output closes when drive exceeds value set in [Above Freq Val].</i> "Running" <i>Output closes when drive is running</i> "Faulted" <i>Output closes when drive is faulted</i> "Alarm" <i>Output closes when the drive reaches hardware current limit, software current limit, overvoltage, line loss or 4-20 mA loss.</i> "Balanced" <i>Output closes when a balance condition is detected.</i> "Above Curr" <i>Output closes when current exceeds value set in [Above Curr Val].</i>

Application Note: During power up of the drive, the customer programmable Outputs 1 & 2 (TB2–9 & 10, TB2– 19 & 20) are in an indeterminate state for a period of time until the internal control of the drive has initialized (3 sec. max.). Any control system connected to the programmable outputs should take this into consideration. On power down, the programmable outputs may transition in a similar way.

Output Configuration Group (cont.)

<p>[Analog Out Sel]</p> <p>This parameter selects the value to which the 0-10V DC analog output at TB2-5 terminal is proportional.</p>	<table border="1"> <tbody> <tr> <td>Parameter #</td> <td>25</td> <td>Factory Default</td> <td>"Frequency"</td> </tr> <tr> <td>Parameter Type</td> <td>Read & Write</td> <td>Setting</td> <td>"Frequency" 0 to [Maximum Freq]</td> </tr> <tr> <td>Units</td> <td>None</td> <td></td> <td>"Current" 0 to 200% of Rated Drive Output Current)</td> </tr> <tr> <td></td> <td></td> <td></td> <td>"Bus Volts" 0 to Maximum Bus Voltage– 410V/230V Drives 815V/460V Drives</td> </tr> <tr> <td></td> <td></td> <td></td> <td>"Power" 0 to 200% of Drive Rated OutputPower</td> </tr> </tbody> </table>	Parameter #	25	Factory Default	"Frequency"	Parameter Type	Read & Write	Setting	"Frequency" 0 to [Maximum Freq]	Units	None		"Current" 0 to 200% of Rated Drive Output Current)				"Bus Volts" 0 to Maximum Bus Voltage– 410V/230V Drives 815V/460V Drives				"Power" 0 to 200% of Drive Rated OutputPower	
Parameter #	25	Factory Default	"Frequency"																			
Parameter Type	Read & Write	Setting	"Frequency" 0 to [Maximum Freq]																			
Units	None		"Current" 0 to 200% of Rated Drive Output Current)																			
			"Bus Volts" 0 to Maximum Bus Voltage– 410V/230V Drives 815V/460V Drives																			
			"Power" 0 to 200% of Drive Rated OutputPower																			
<p>[Above Freq Val]</p> <p>This parameter is used when [Output 1 Config] or [Output 2 Config] is set to "Above Freq" to indicate when the drive is operating above the specified frequency setting.</p>	<table border="1"> <tbody> <tr> <td>Parameter #</td> <td>77</td> <td>Factory Default</td> <td>0 Hz</td> </tr> <tr> <td>Parameter Type</td> <td>Read & Write</td> <td>Minimum</td> <td>0 Hz</td> </tr> <tr> <td>Units</td> <td>Hertz</td> <td>Maximum</td> <td>400 Hz</td> </tr> </tbody> </table>	Parameter #	77	Factory Default	0 Hz	Parameter Type	Read & Write	Minimum	0 Hz	Units	Hertz	Maximum	400 Hz	<p>IMPORTANT: This parameter can not be programmed while the drive is running.</p>								
Parameter #	77	Factory Default	0 Hz																			
Parameter Type	Read & Write	Minimum	0 Hz																			
Units	Hertz	Maximum	400 Hz																			
<p>[Above Curr Val]</p> <p>This parameter is used when [Output 1 Config] or [Output 2 Config] is set to "Above Curr" to indicate when the drive output current exceeds this value.</p>	<table border="1"> <tbody> <tr> <td>Parameter #</td> <td>142</td> <td>Factory Default</td> <td>0 % of Drive Rated Current ①</td> </tr> <tr> <td>Parameter Type</td> <td>Read & Write</td> <td>Minimum</td> <td>0 % of Drive Rated Current ①</td> </tr> <tr> <td>Units</td> <td>1%</td> <td>Maximum</td> <td>150% of Drive Rated Current ①</td> </tr> </tbody> </table>	Parameter #	142	Factory Default	0 % of Drive Rated Current ①	Parameter Type	Read & Write	Minimum	0 % of Drive Rated Current ①	Units	1%	Maximum	150% of Drive Rated Current ①									
Parameter #	142	Factory Default	0 % of Drive Rated Current ①																			
Parameter Type	Read & Write	Minimum	0 % of Drive Rated Current ①																			
Units	1%	Maximum	150% of Drive Rated Current ①																			

① The drive rated output current is based on three phase input ratings. See page 5-13 for Single Phase Input Rating instructions.

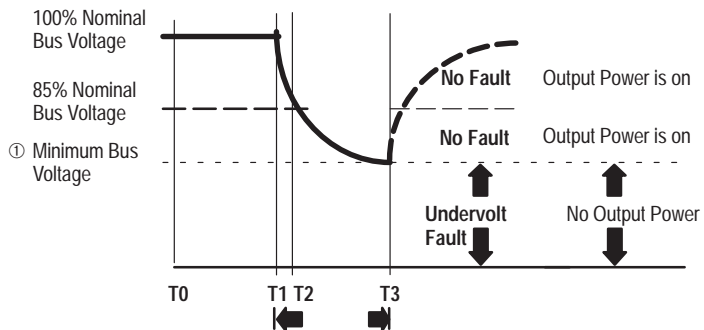
Faults

This group of parameters provides information and programmed settings on commonly viewed drive faults.

<p>[Fault Buffer 0-3]</p> <p>These parameters store the last (4) faults that occur. If the same fault occurs multiple times in a row, it will only be stored once. [Fault Buffer 0] through [Fault Buffer 3] can only be cleared by “Reset Defaults” from EEPROM mode or [Set Defaults] parameter. This will leave a “F48” in [Fault Buffer 0].</p>	<p>Parameter # 86-89</p> <p>Parameter Type Read Only</p> <p>Units None</p>	<p>Factory Default None</p> <p>Buffer</p> <ul style="list-style-type: none"> 0 1 2 3 	<p><i>Last Fault, stored in EEPROM</i></p> <p><i>Fault from Buffer 0, Stored in EEPROM</i></p> <p><i>Fault from Buffer 1, Stored in EEPROM</i></p> <p><i>Fault from Buffer 2, Stored in EEPROM</i></p>
<p>[Clear Fault]</p> <p>This parameter is used to clear a fault and return the drive to ready status if the fault condition no longer exists.</p> <p>IMPORTANT: [Clear Fault] will stop a running drive. Also [Clear Fault] does not clear [Fault Buffer 0] through [Fault Buffer 3].</p>	<p>Parameter # 51</p> <p>Parameter Type Read & Write</p> <p>Units None</p>	<p>Factory Default “Ready”</p> <p>Displays “Ready”</p> <p>“Clear Fault”</p>	<p><i>Display after function complete</i></p> <p><i>Attempts to clear fault</i></p>
<p>[Cur Lim Trip En]</p> <p>This setting determines whether or not exceeding the setting in [Current Limit] will cause a Diagnostic Current Limit Fault (Fault F36).</p>	<p>Parameter # 82</p> <p>Parameter Type Read & Write</p> <p>Units None</p>	<p>Factory Default “Default Run”</p> <p>Setting “Trip @ I Lim”</p> <p>“Default Run”</p>	<p><i>A Diagnostic Current Limit Fault is generated</i></p> <p><i>No fault generated</i></p>
<p>[Line Loss Fault]</p> <p>This setting determines whether a 15% drop in DC Bus voltage will have no effect on operation or cause a “Power Loss Fault” (fault F03).</p>	<p>Parameter # 40</p> <p>Parameter Type Read & Write</p> <p>Units None</p>	<p>Factory Default “F03 Enable”</p> <p>Setting “UVolt Run”</p> <p>“FO3 Enable”</p>	<p><i>“Power Loss Fault” Disabled</i></p> <p><i>Drive Trips at 85% of nominal bus voltage.</i></p>

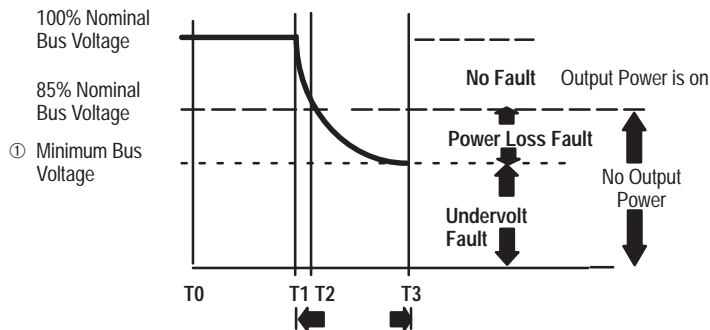
Faults Group (cont.)

Line Loss Fault “U Volt Run” (Disabled)



① Minimum bus voltage is approximately 70% of Line Voltage

Line Loss Fault “F03 Enable” (Enabled)



IMPORTANT: If line loss is set to “U Volt Run” and “Run On Power Up” is enabled, the drive will run as long as the bus voltage is high enough to maintain logic.

[Fit Clear Mode]

This parameter controls the method for clearing faults.

Parameter #	39	Factory Default	“Enabled”
Parameter Type	Read & Write		
Units	None	Setting	“Enabled”
			<i>Faults Cleared By Issuing a Valid Stop Command or Cycling Input Power</i>
			“Disabled”
			<i>Faults Cleared Only By Cycling Input Power</i>

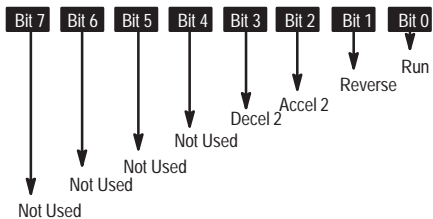
Diagnostics

This group of parameters contains values that can be helpful in explaining the operation of the drive. Drive status, direction, control and alarm conditions are included.

[Drive Command]

This parameter displays the status of the drive commands in an 8-bit binary format.

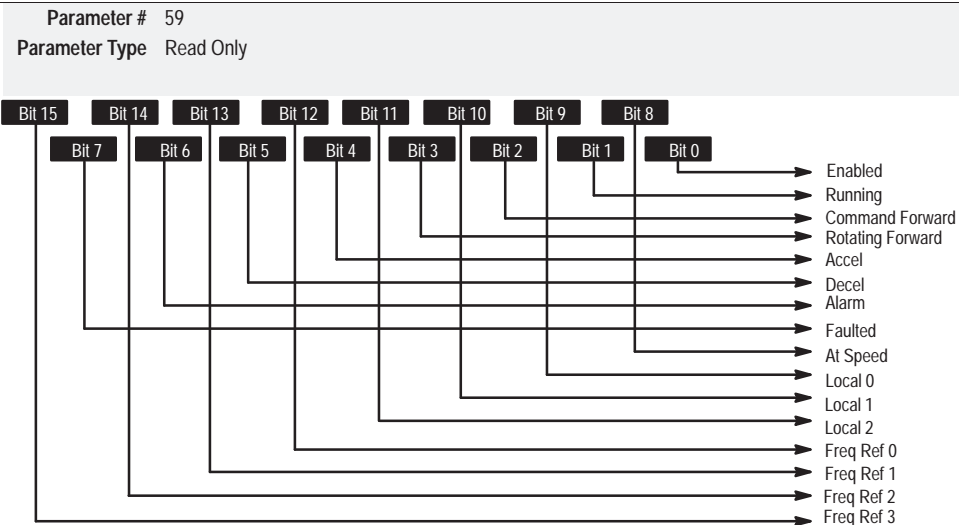
Parameter # 58
Parameter Type Read Only



Diagnostics Group (cont.)

[Drive Status]

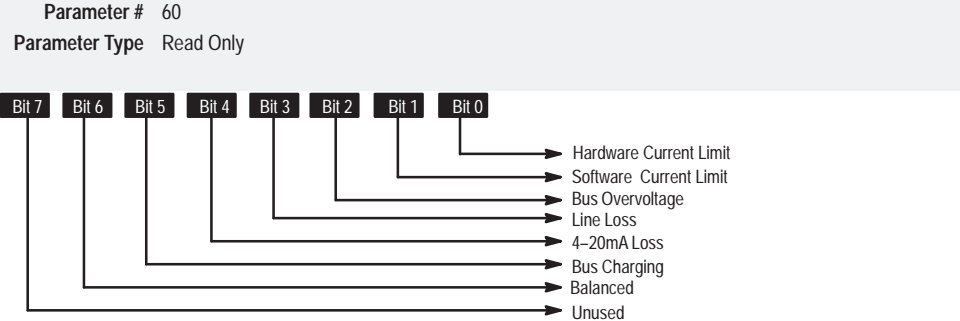
This parameter displays the actual operating condition in 16 bit binary format.



Diagnostics Group (cont.)

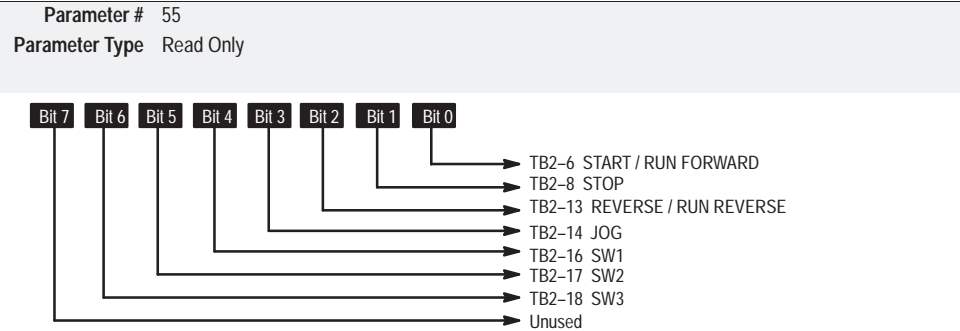
[Drive Alarm]

This parameter displays which alarm condition is present when bit 6 of [Drive Status] is high (set to 1)



[Input Status]

This parameter displays the open (0) and closed (1) status of inputs at TB2. Refer to Figure 2.7 and Figure 2.8 for description of terminal connections.



Diagnostics Group (cont.)**[Freq Source]**

This parameter displays the frequency source currently commanding the drive.

Parameter #	62		
Parameter Type	Read		
Units	None	Displays	"Remote Pot" "0-10 Volt" "4-20 mA" "MOP" "Adapter 1" "Adapter 2" "Adapter 3" "Adapter 4" "Adapter 5" "Adapter 6"
			"Preset 1" "Preset 2" "Preset 3" "Preset 4" "Preset 5" "Preset 6" "Preset 7"

[Freq Command]

This parameter displays the frequency that the drive is commanded to output. This command may come from any one of the frequency sources selected by **[Freq Select 1]**, **[Freq Select 2]** or **[Preset Freq 1-7]** as determined by inputs to SW1, SW2 and SW3 at TB2.

Parameter #	65	Factory Default	0.00 Hz
Parameter Type	Read Only	Minimum	0 Hz
Units	0.01 Hz	Maximum	400.00 Hz

[Drive Direction]

This parameter displays the running direction of the drive.

Parameter #	69	Factory Default	"Forward"
Parameter Type	Read Only	Minimum	
Units	None	Displays	"Forward" "Reverse"

[Motor Mode]

This parameter is used for internal diagnostic purposes.

Parameter #	43
Parameter Type	Read Only

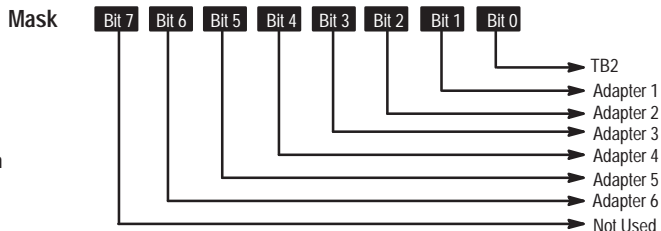
Diagnostics Group (cont.)

<p>[Power Mode]</p> <p>This parameter is used for internal diagnostic purposes.</p>	<p>Parameter # 44</p> <p>Parameter Type Read Only</p>	
<p>[Drive Type]</p> <p>This parameter displays a decimal number that identifies the drive.</p>	<p>Parameter # 61</p> <p>Parameter Type Read Only</p> <p>Units None</p>	
<p>[Drive Firmware]</p> <p>This parameter displays the version number of the drive firmware.</p>	<p>Parameter # 71</p> <p>Parameter Type Read Only</p>	<p>Factory Default None</p> <p>Display 0.00</p>
<p>[Output Pulses]</p> <p>This parameter displays the number of output cycles for the PWM waveform. The count rolls over at 65535.</p>	<p>Parameter # 67</p> <p>Parameter Type Read Only</p> <p>Units Cycles</p>	<p>Factory Default None</p> <p>Minimum 0</p> <p>Maximum 65535</p>
<p>[Drive Temp]</p> <p>This parameter displays the internal drive temperature.</p>	<p>Parameter # 70</p> <p>Parameter Type Read Only</p> <p>Units 1°C</p>	<p>Factory Default None</p> <p>Minimum 0°C</p> <p>Maximum Not Applicable</p>
<p>[Set Defaults]</p> <p>Setting parameter to "Default Init" resets all parameters to their factory values. See also page 3-10 EEPROM Mode.</p>	<p>Parameter # 64</p> <p>Parameter Type Read & Write</p> <p>Units None</p> <p>IMPORTANT: This parameter can not be programmed while the drive is running.</p>	<p>Factory Default "Ready"</p> <p>Settings "Ready" <i>Display After Function Complete</i></p> <p>"Store to EE" <i>Saves parameter Ram to EEPROM</i></p> <p>"Recl frm EE" <i>Restores parameter Ram from EEPROM</i></p> <p>"Default Init" <i>Resets All Parameters to Their Factory Settings</i></p>

Masks

Each mask contains a bit for each adapter. Individual bits can be set to “0” to lockout control by an adapter or set to “1” to permit an adapter to have control.

This group of parameters contains binary masks for all control functions except the stop command. The masks control which adapters can issue control commands.



[Logic Mask]

This parameter determines which adapters are allowed to control the drive logic commands. Setting a bit to “0” (deny control) disables all command functions except stop and frequency reference. **IMPORTANT:** In order to remove an adapter from the drive without causing a drive communications fault, the corresponding bit for that adapter must be set to 0. **IMPORTANT:** This parameter has no effect on the frequency value being sent from TB2 or any of the adapters.

Parameter #	92	Factory Default	01111111
Parameter Type	Read & Write		
Units	Byte	Settings	1 <i>Permit Control</i> 0 <i>Deny Control</i>

[Direction Mask]

This parameter determines which adapters can issue forward/reverse commands. **IMPORTANT:** The direction mask is unique in that no adapters can control direction unless TB2 (Bit 0) is set to “0”.

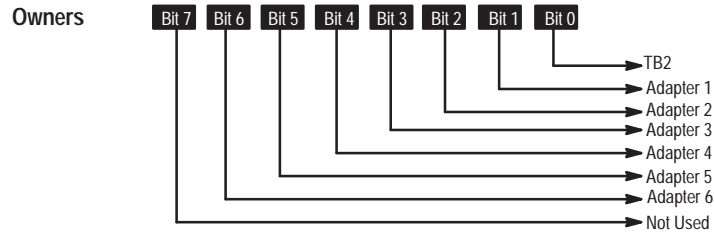
Parameter #	94	Factory Default	01111111
Parameter Type	Read & Write		
Units	Byte	Settings	1 <i>Permit Control</i> 0 <i>Deny Control</i>

Masks Group (cont.)

<p>[Start Mask]</p> <p>This parameter determines which adapters can issue start commands.</p>	<p>Parameter # 95</p> <p>Parameter Type Read & Write</p> <p>Units Byte</p>	<p>Factory Default 01111111</p> <p>Settings 1 0</p>	<p>01111111</p> <p><i>Permit Control</i></p> <p><i>Deny Control</i></p>
<p>[Jog Mask]</p> <p>This parameter determines which adapters can issue jog commands.</p>	<p>Parameter # 96</p> <p>Parameter Type Read & Write</p> <p>Units Byte</p>	<p>Factory Default 01111111</p> <p>Settings 1 0</p>	<p>01111111</p> <p><i>Permit Control</i></p> <p><i>Deny Control</i></p>
<p>[Reference Mask]</p> <p>This parameter determines which adapters can control the switching between the available freq. reference sources. IMPORTANT: Terminal Block (TB2) will have control unless masked out.</p>	<p>Parameter # 97</p> <p>Parameter Type Read & Write</p> <p>Units Byte</p>	<p>Factory Default 01111111</p> <p>Settings 1 0</p>	<p>01111111</p> <p><i>Permit Control</i></p> <p><i>Deny Control</i></p>
<p>[Accel Mask]</p> <p>This parameter determines which adapters can switch between [Accel Time 1] and [Accel Time 2]. IMPORTANT: Terminal Block (TB2) will have control unless masked out.</p>	<p>Parameter # 98</p> <p>Parameter Type Read & Write</p> <p>Units Byte</p>	<p>Factory Default 01111111</p> <p>Settings 1 0</p>	<p>01111111</p> <p><i>Permit Control</i></p> <p><i>Deny Control</i></p>
<p>[Decel Mask]</p> <p>This parameter determines which adapters can switch between [Decel Time 1] and [Decel Time 2]. IMPORTANT: Terminal Block (TB2) will have control unless masked out.</p>	<p>Parameter # 99</p> <p>Parameter Type Read & Write</p> <p>Units Byte</p>	<p>Factory Default 01111111</p> <p>Settings 1 0</p>	<p>01111111</p> <p><i>Permit Control</i></p> <p><i>Deny Control</i></p>

Owners

This group of parameters contains binary status information to display which adapters are issuing control commands.



<p>[Stop Owner]</p> <p>This parameter displays which adapters are currently issuing a valid stop command.</p>	<p>Parameter # 102</p> <p>Parameter Type Read Only</p> <p>Units Byte</p>	<p>Settings 1 0</p> <p>Controlling Not Controlling</p>
<p>[Direction Owner]</p> <p>This parameter displays which adapter currently has exclusive control of direction changes. When commanding the direction from an adapter, the corresponding bit is set to "1".</p> <p>IMPORTANT: Only one adapter is allowed to control direction at any instance.</p>	<p>Parameter # 103</p> <p>Parameter Type Read Only</p> <p>Units Byte</p>	<p>Settings 1 0</p> <p>Controlling Not Controlling</p>

Owners Group (cont.)**[Start Owner]**

This parameter displays which adapters are currently issuing Start commands. Since Start commands are edge triggered, multiple adapters can issue the Start command simultaneously and as such are displayed. However, it is the first low to high transition of the Start (once all Stops and/or Faults are removed) that initiates the actual Start command.

Parameter #	104			
Parameter Type	Read Only			
Units	Byte	Settings	1	<i>Controlling</i>
			0	<i>Not Controlling</i>

[Jog Owner]

This parameter displays which adapters are currently issuing JOG commands. Since the JOG function is momentary, multiple adapters can issue Jog commands simultaneously. This means that all adapters issuing the JOG must stop commanding the JOG before the function ceases. **IMPORTANT:** Stop commands will terminate JOG control and Start commands will override any JOG command.

Parameter #	105			
Parameter Type	Read Only			
Units	Byte	Settings	1	<i>Controlling</i>
			0	<i>Not Controlling</i>

Owners Group (cont.)

<p>[Reference Owner]</p> <p>This parameter displays which adapter has exclusive control of selecting the [Freq Source].</p>	<p>Parameter # 106 Parameter Type Read Only Units Byte</p>	<p>Settings 1 0</p>	<p><i>Controlling</i> <i>Not Controlling</i></p>
<p>[Accel Owner]</p> <p>This parameter displays which adapter currently is exclusively controlling the selection between [Accel Time 1] and [Accel Time 2].</p>	<p>Parameter # 107 Parameter Type Read Only Units Byte</p>	<p>Settings 1 0</p>	<p><i>Controlling</i> <i>Not Controlling</i></p>
<p>[Decel Owner]</p> <p>This parameter displays which adapter currently is exclusively controlling the selection between [Decel Time 1] and [Decel Time 2].</p>	<p>Parameter # 108 Parameter Type Read Only Units Byte</p>	<p>Settings 1 0</p>	<p><i>Controlling</i> <i>Not Controlling</i></p>
<p>[Fault Owner]</p> <p>This parameter displays which adapters are currently issuing a [Clear Faults] Command. Multiple adapters can issue simultaneous [Clear Faults] Commands.</p>	<p>Parameter # 109 Parameter Type Read Only Units Byte</p>	<p>Settings 1 0</p>	<p><i>Controlling</i> <i>Not Controlling</i></p>

Owners Group (cont.)

<p>[MOP Owner]</p> <p>This parameter displays which adapters are currently issuing increases or decreases in MOP Command Frequency. Multiple adapters can issue changes simultaneously to the MOP value.</p>	<p>Parameter # 110</p> <p>Parameter Type Read Only</p> <p>Units Byte</p>	<p>Settings 1 0</p>	<p><i>Controlling</i> <i>Not Controlling</i></p>
<p>[Local Owner]</p> <p>This parameter displays which adapter currently has exclusive control of all drive logic functions by requesting a Local command. If an adapter is the [Local Owner], all other functions (except stop) on all other adapters are locked out and non-functional. IMPORTANT: Local control can only be granted when the drive is in a safe state or stopped.</p>	<p>Parameter # 137</p> <p>Parameter Type Read Only</p> <p>Units Byte</p>	<p>Settings 1 0</p>	<p><i>Controlling</i> <i>Not Controlling</i></p>

Adapter I/O

This group contains the parameters needed for an optional communications adapter to communicate with the drive.

[Data In A1 through D2]

These parameters are used to write real time data values from a source controller (PLC, SLC, etc.) to the drive. This is accomplished by programming a Parameter Number into the [Data In] parameters. The value programmed into the source controller's output image table will be written to the drive parameter identified in the corresponding [Data In] parameter.

IMPORTANT: [Preset Freq 1] through [Preset Freq 7] are not accessible with these parameters.

IMPORTANT: The drive parameter that is accessed indirectly using Data In will not be stored permanently and automatically to EEPROM (due to the high potential update rate from a PLC). A manual operation is necessary for permanent storage. The HIM EEPROM command, Save Values, will perform this task. Similarly, to restore the values to the ones the drive had before Data In was configured, the HIM Recall Values Function can be used.

Parameter # 111 - 118
Parameter Type Read & Write

Parameter	Bulletin 1305 drive
111	Data In A1
112	Data In A2
113	Data In B1
114	Data In B2
115	Data In C1
116	Data In C2
117	Data In D1
118	Data In D2

Controller Output Image Table (i.e. PLC, SLC, etc.)

IMPORTANT: addressing information that defines which controller I/O address corresponds to a [Data In] parameter is determined by the dip switch settings on the external communication module. Refer to the appropriate Bulletin 1203 Communication Module User Manual for details.

Refer to Appendix B for additional information.

Adapter I/O Group (cont.)

[Data Out A1 through D2]

These parameters are used to write real time data values from the drive to a destination controller. This is accomplished by programming a Parameter Number into the [Data Out] parameters. The real time value of that parameter will be written to the input image table of the destination controller.

IMPORTANT: [Preset Freq 1] through [Preset Freq 7] are not accessible with these parameters.

Parameter # 119 - 126
Parameter Type Read & Write

Parameter

119	Data Out A1	➔
120	Data Out A2	➔
121	Data Out B1	➔
122	Data Out B2	➔
123	Data Out C1	➔
124	Data Out C2	➔
125	Data Out D1	➔
126	Data Out D2	➔

Bulletin 1305 drive

Controller Input Image Table (i.e. PLC, SLC, etc.)

IMPORTANT: addressing information that defines which controller I/O address corresponds to a [Data Out] parameter is determined by the dip switch settings on the external communication module. Refer to the appropriate Bulletin 1203 Communication Module User Manual for details.

Refer to Appendix B for additional information.

Process Display

This group contains parameters that can be used to display a drive parameter in “User Units.”

<p>[Process Par]</p> <p>This parameter should be set to the number of the parameter whose scaled value will be displayed on Line 1 of the HIM Display Panel when in process mode.</p>	<table border="1"> <tbody> <tr> <td>Parameter #</td> <td>127</td> <td>Factory Default</td> <td>1</td> </tr> <tr> <td>Parameter Type</td> <td>Read & Write</td> <td>Minimum</td> <td>1</td> </tr> <tr> <td>Units</td> <td>Numeric</td> <td>Maximum</td> <td>Max. Parameter Number</td> </tr> </tbody> </table>	Parameter #	127	Factory Default	1	Parameter Type	Read & Write	Minimum	1	Units	Numeric	Maximum	Max. Parameter Number
Parameter #	127	Factory Default	1										
Parameter Type	Read & Write	Minimum	1										
Units	Numeric	Maximum	Max. Parameter Number										
<p>[Process Scale]</p> <p>This value sets the scaling multiplier for [Process Par]. The displayed value will be:</p> $\times \frac{\text{[Process Par] actual value}}{\text{[Process Scale] value}}$ <p>Displayed Value ①</p>	<table border="1"> <tbody> <tr> <td>Parameter #</td> <td>128</td> <td>Factory Default</td> <td>+1.00</td> </tr> <tr> <td>Parameter Type</td> <td>Read & Write</td> <td>Minimum</td> <td>-327.68</td> </tr> <tr> <td>Units</td> <td>Numeric</td> <td>Maximum</td> <td>+327.67</td> </tr> </tbody> </table>	Parameter #	128	Factory Default	+1.00	Parameter Type	Read & Write	Minimum	-327.68	Units	Numeric	Maximum	+327.67
Parameter #	128	Factory Default	+1.00										
Parameter Type	Read & Write	Minimum	-327.68										
Units	Numeric	Maximum	+327.67										
<p>[Process Txt 1-8]</p> <p>These parameters set the “User Units” description for the value determined by [Process Par] and [Process Scale]. This text is displayed on Line 1 of the HIM.</p>	<table border="1"> <tbody> <tr> <td>Parameter #(s)</td> <td>129-136</td> <td>Factory Default</td> <td>“?”</td> </tr> <tr> <td>Parameter Type</td> <td>Read & Write</td> <td></td> <td></td> </tr> <tr> <td>Units</td> <td>ASCII Text Character</td> <td></td> <td></td> </tr> </tbody> </table>	Parameter #(s)	129-136	Factory Default	“?”	Parameter Type	Read & Write			Units	ASCII Text Character		
Parameter #(s)	129-136	Factory Default	“?”										
Parameter Type	Read & Write												
Units	ASCII Text Character												

- ① *The maximum value that can be displayed is 99,999.99. If this value is exceeded a character string of asterisks (.....) will appear on the display.*

Linear List

1	Output Voltage	24	Jog Frequency	47	Language	72	Upper Presets	95	Start Mask	118	Data In D2
2	% Output Curr	25	Analog Out Sel	48	Start Boost	73	Preset Freq 4	96	Jog Mask	119	Data Out A1
3	% Output Power	26	Prst/2nd Accel	49	Break Frequency	74	Preset Freq 5	97	Reference Mask	120	Data Out A2
4	Last Fault	27	Preset Freq 1	50	Break Voltage	75	Preset Freq 6	98	Accel Mask	121	Data Out B1
5	Freq Select 1	28	Preset Freq 2	51	Clear Fault	76	Preset Freq 7	99	Decel Mask	122	Data Out B2
6	Freq Select 2	29	Preset Freq 3	52	Compensation	77	Above Freq Val	100	Fault Mask	123	Data Out C1
7	Accel Time 1	30	Accel Time 2	53	DC Bus Voltage	78	Balance Angle	101	MOP Mask	124	Data Out C2
8	Decel Time 1	31	Decel Time 2	54	Output Current	79	Balance Time	102	Stop Owner	125	Data Out D1
9	DC Boost Select	32	Skip Freq 1	55	Input Status	80	Balance Freq	103	Direction Owner	126	Data Out D2
10	Stop Select	33	Skip Freq 2	56	S Curve Time	81	4–20mA Loss Sel	104	Start Owner	127	Process Par
11	DB Enable	34	Skip Freq 3	57	S Curve Enable	82	Cur Lim Trip En	105	Jog Owner	128	Process Scale
12	DC Hold Time	35	Skip Freq Band	58	Drive Command	83	Run Boost	106	Reference Owner	129	Process Text 1
13	DC Hold Level	36	Current Limit	59	Drive Status	84	Analog Invert	107	Accel Owner	130	Process Text 2
14	Run On Power Up	37	Overload Mode	60	Drive Alarm	85	Reset/Run Tries	108	Decel Owner	131	Process Text 3
15	Reset/Run Time	38	Overload Current	61	Drive Type	86	Fault Buffer 0	109	Fault Owner	132	Process Text 4
16	Minimum Freq	39	Fit Clear Mode	62	Freq Source	87	Fault Buffer 1	110	MOP Owner	133	Process Text 5
17	Base Frequency	40	Line Loss Fault	64	Set Defaults	88	Fault Buffer 2	111	Data in A1	134	Process Text 6
18	Base Voltage	41	Motor Type	65	Freq Command	89	Fault Buffer 3	112	Data In A2	135	Process Text 7
19	Maximum Freq	42	MOP Hertz	66	Output Freq	90	Output 1 Config	113	Data In B1	136	Process Text 8
20	Maximum Voltage	43	Motor Mode	67	Output Pulses	91	Output 2 Config	114	Data In B2	137	Local Owner
21	Input Mode	44	Power Mode	69	Drive Direction	92	Logic Mask	115	Data In C1	141	Sec Curr Limit
22	MOP Increment	45	PWM Frequency	70	Drive Temp	93	Local Mask	116	Data In C2	142	Above Curr Val
23	Output Power	46	Current Angle	71	Firmware Ver	94	Direction Mask	117	Data In D1		

This group lists all parameters in numerical order.

CHAPTER OBJECTIVES

Chapter 6 provides information to guide the user in understanding drive fault conditions and general troubleshooting procedures for Bulletin 1305 drives. Included is a listing and description of the various drive faults with possible solutions, when applicable. Also included is a section on general troubleshooting. (Refer to Table 6.C).

FAULT INFORMATION

Figure 6.1 Fault Display



Drives equipped with a Human Interface Module will display a brief fault message on Line 1 of the LCD display when a fault occurs. Line 2 of the display indicates the corresponding fault number.

IMPORTANT: For Series A HIM software version 3.00 and Above or Series B HIM software version 1.01 and Above, faults are displayed as soon as they occur. Earlier versions only display faults when the HIM is in the **Status Display Mode**. [**Fault Buffer 0**] through [**Fault Buffer 3**] display previous faults.

Table 6.A lists all faults numerically with a cross reference to the page number where information can be found relating to that fault. Table 6.B provides an alphabetized listing of the faults with a description and possible corrective action to take.

Fault LED

All drives come equipped with a fault LED. When the fault LED is illuminated it is an indication a fault condition exists. Refer to page 2-3 for the location of the fault LED. Once the fault is properly cleared the LED will return to an off state.

Diagnostics

As can be seen in Figure 2.3, there are two indicators provided to display the drive's status condition. The DC Bus Charge Indicator is a neon bulb that will be illuminated when power is applied to the drive. The Fault Indicator is an LED that will be illuminated if a drive fault condition exists. Refer to details on How To Clear a Fault, below.

How To Clear a Fault

IMPORTANT: Resetting a fault will not correct the cause of the fault condition. Corrective action must be taken prior to resetting the fault.

To clear a fault perform one of the following:

1. Cycle power to the drive.
2. Cycle the stop signal to the drive.
3. Cycle the [**Clear Fault**] parameter. See page 5-34.

IMPORTANT: The stop signal will not clear a fault if the [**Logic Mask**] or [**Fault Mask**] bit of that adapter has been disabled or the [**Fault Clear Mode**] parameter is disabled.

Table 6.A Fault Code Cross Reference

Fault Number	Fault Name	Page Number	Fault Number	Fault Name	Page Number
F3	Power Loss Fault	6-7	F34	Run Boost Fault	6-7
F4	Undervolt Fault	6-8	F35	Neg Slope Fault	6-5
F5	Overvolt Fault	6-6	F36	Diag C Lim Flt	6-3
F6	Motor Stall Fault	6-5	F38	Phase U Fault	6-7
F7	Overload Fault	6-6	F39	Phase V Fault	6-7
F8	Overtemp Fault	6-6	F40	Phase W Fault	6-7
F9	Open Pot Fault	6-6	F41	UV Short Fault	6-8
F10	Serial Fault	6-8	F42	UW Short Fault	6-8
F11	Op Error Fault	6-6	F43	VW Short Fault	6-8
F12	Overcurrent Flt	6-6	F44	IPM Current Fault	6-4
F22	Drive Reset Flt	6-3	F45	IPM Overtemp Fault	6-4
F24	Motor Mode Flt	6-5	F46	Power Test Fault	6-6
F25	Overspeed Flt	6-6	F48	Reprogram Fault	6-7
F26	Power Mode Fault	6-7	-	Drive → HIM ^①	6-3
F29	Hz Err Fault	6-3	-	HIM → Drive ^①	6-4
F30	Hz Sel Fault	6-3	-	Network Error * ^①	6-5
F32	EEprom Fault	6-3	-	Pin ID Error ^①	6-7
F33	Max Retries Fault	6-4			

^① These faults are generated in the HIM and not stored in the drive EEPROM.

Table 6.B Bulletin 1305 Fault Descriptions

Fault Name & Number	Fault Description	Action to Take
Diag C Lim Fault F36	The drive output current has exceeded the software [Current Limit] and the [Cur Lim Trip En] parameter was enabled.	Check programming of [Curr Lim Trip En] parameter. Check for excess load, improper DC boost setting, DC brake volts set too high or other causes of excess current.
Drive → HIM	The checksum read from the HIM's EEPROM does not match the checksum calculated from the EEPROM data.	Repeat operation. Replace HIM.
Drive Reset Fault F22	Occurs on power-up. Caused by having the Start Input (or Run Input) closed, with the Stop Input open and [Run On Power Up] = Disabled.	Check stop connection at TB2, terminal 8.
EEPROM Fault F32	EEPROM has invalid data or can not be programmed to valid data.	Check cable connection from main control board to power board. Reset to Default Parameters and Cycle power.
H_z Err Fault F29	This fault indicates that there is not a valid operating frequency. It can be caused by any of the following: <ol style="list-style-type: none"> 1. [Maximum Frequency] is less than [Minimum Freq]. 2. Skip frequencies and skip bandwidth eliminate all operating frequencies. 3. 4-20mA input signal speed reference has been lost or is out of range and [4-20mA Loss Sel] is set for "Stop-Fault." 4. The adapter that was the active frequency source was disconnected. 	<ol style="list-style-type: none"> 1. Check [Minimum Freq] and [Maximum Freq] parameters. 2. Check [Skip Freq 1], [Skip Freq 2], [Skip Freq 3] and [Skip Freq Band] parameters. 3. Check for broken wires, loose connections or transducer loss at 4-20mA input, TB2. 4. Active frequency source cannot be removed.
H_z Sel Fault F30	Internal error.	Reset drive to factory defaults.

Table 6.B Bulletin 1305 Fault Descriptions (cont.)

Fault Name & Number	Fault Description	Action to Take
HIM → Drive	<p>Error 1 – The checksum read from the HIM's EEPROM does not match the checksum calculated from the EEPROM data.</p> <p>Error 2 – The number of parameters in saved profile does not equal master.</p> <p>Error 3 – Download was attempted to a different type drive (i.e. 1336->1305).</p> <p>Error 4 – Saved data for parameter not correct for new drive.</p> <p>Error 5 – Drive is running while attempting download.</p>	<p>Repeat operation. Old profile corrupt. Save new profile. Repeat operation.</p> <p>The last parameter programmed will be displayed on the top line. Verify that all parameters have been programmed. If not, manually program any remaining parameters.</p> <p>Download can only take place with the same type of drive.</p> <p>Capabilities of drive are different than the master drive. Press Enter to continue download. When download is complete, manually program the parameter where the error occurred.</p> <p>Stop drive, then perform download.</p>
IPM Current Fault F44	The internal power module overcurrent limit had been exceeded.	Check for short circuit at the drive output or excessive load conditions at the motor, specifically cable capacitance to ground.
IPM Overtemp Fault F45	The internal power module thermal limit has been exceeded.	Check for blocked or dirty heat sink fins. Check for proper mounting and spacing (See page 2-1). Check if the ambient temperature limit has been exceeded.
Max Retries Fault F33	Drive unsuccessfully attempted to reset a fault and resume running for the programmed number of [Reset/Run Tries] .	Check fault buffer for fault code requiring reset. Correct the cause of the fault and manually clear by cycling the stop command or cycling power.

Table 6.B Bulletin 1305 Fault Descriptions (cont.)

Fault Name & Number	Fault Description	Action to Take
Motor Mode Fit F24	Internal error.	Reset drive to factory defaults.
Motor Stall Fault F6	The motor is stalled.	If the motor is drawing excessive current, the motor load is excessive and will not allow the drive to accelerate to set speed. A longer accel time or a reduced load may be required.
Neg Slope Fault F35	Drive software detected a portion of the volts/Hz curve with a negative slope.	<p>Check drive programming.</p> <ol style="list-style-type: none"> 1. [Maximum Voltage] parameter must be greater than or equal to [Base Voltage]. 2. [Base Voltage] parameter must be greater than 1.5 X [Start Boost]. 3. If the [DC Boost Select] parameter is set to "Break Point," [Base Voltage] must be greater than [Break Voltage] and [Break Voltage] must be greater than [Start Boost]. 4. [Maximum Freq] must be greater than or equal to [Base Frequency]
Network Error *	<p>Network Error 0 – Error 6 ScanPort Error</p> <p>Network Error 7 – Error 9 Communications Error</p>	<ol style="list-style-type: none"> 1. Press the "Up" or "Down" arrow to clear the message from the HIM display. 2. Unplug the HIM from the cable or drive and re-connect. 3. Check for external noise sources.

Table 6.B Bulletin 1305 Fault Descriptions (cont.)

Fault Name & Number	Fault Description	Action to Take
Op Error Fault F11	Internal error.	Reset drive to factory defaults.
Open Pot Fault F9	An external pot is connected and the ground lead of the pot is disconnected creating a potential drive overspeed hazard.	Check the external potentiometer circuit at TB2, terminals 1, 2 and 3 for an open circuit.
Overcurrent Fault F12	Overcurrent is detected in overcurrent hardware trip circuit.	Check for a short circuit at the drive output or excessive load conditions at the motor.
Overload Fault F7	Internal electronic overload trip.	An excessive motor load exists. It must be reduced such that drive output current does not exceed the % of current set by the [Overload Current] parameter. Reduce [Start Boost]
Overspeed Fault F25	Internal error.	Reset drive to factory defaults.
Overtemp Fault F8	Temperature sensor detects excessive heat.	Check for blocked or dirty heat sink fins. Check for proper mounting and spacing (See page 2-1). Check if the ambient temperature limit has been exceeded.
Overvolt Fault F5	DC bus voltage exceeded maximum value.	Monitor the AC line for high line voltage or transient conditions. Bus overvoltage can also be caused by motor regeneration. Extend the decel time or install dynamic brake option.

Table 6.B Bulletin 1305 Fault Descriptions (cont.)

Fault Name & Number	Fault Description	Action to Take
Pin ID Error	Communication Hardware problem.	1. Unplug the HIM from the cable or drive and re-connect. 2. Replace Communication Cable.
Phase U Fault F38	A phase to ground fault has been detected between the drive and motor in this phase.	Check the wiring between the drive and motor. Check motor for grounded phase.
Phase V Fault F39	A phase to ground fault has been detected between the drive and motor in this phase.	Check the wiring between the drive and motor. Check motor for grounded phase.
Phase W Fault F40	A phase to ground fault has been detected between the drive and motor in this phase.	Check the wiring between the drive and motor. Check motor for grounded phase.
Power Loss Fault F3	DC bus voltage remained below 85% of nominal for longer than 0.500 sec. [Line Loss Fault] parameter is programmed to "F03 Enable".	Monitor the incoming AC line for low voltage or line power interruption.
Power Mode Fault F26	Internal error.	Reset drive to factory defaults.
Power Test Fault F46	Fault detected during initial start-up sequence.	Check drive wiring. Check motor wiring. Reset drive to factory defaults.
Reprogram Fault F48	Occurs when drive parameters are reset to defaults.	Clear fault.
Run Boost Fault F34	An attempt has been made to set the [Run Boost] parameter to a value greater than the [Start Boost] parameter.	Verify that parameter has been programmed correctly.

Table 6.B Bulletin 1305 Fault Descriptions (cont.)

Fault Name & Number	Fault Description	Action to Take
Serial Fault F10	An active local bus adapter is disconnected while it possesses control of a local bus function.	Check for break in communications line.
Undervolt Fault F4	DC Bus voltage fell below the minimum value. [Line Loss Fault] parameter is programmed to "U Volt Run".	Monitor the incoming AC line for low voltage or line power interruption.
UV Short Fault F41	Excessive current has been detected between these two drive output terminals.	Check the motor and external wiring to the drive output terminals for a shorted condition.
UW Short Fault F42	Excessive current has been detected between these two drive output terminals.	Check the motor and external wiring to the drive output terminals for a shorted condition.
VW Short Fault F43	Excessive current has been detected between these two drive output terminals.	Check the motor and external wiring to the drive output terminals for a shorted condition.

Note: HIM errors are located on page 6-11.

Table 6.C Troubleshooting

General Problem	Action to Take
Motor does not start (No output voltage to motor) ("Stopped" is displayed on the HIM).	<ol style="list-style-type: none"> (1) Check power circuit <ul style="list-style-type: none"> - Check supply voltage. - Check all fuses and disconnects. (2) Check motor <ul style="list-style-type: none"> - Verify that motor is connected properly. (3) Check control input signals. <ul style="list-style-type: none"> - Verify that Enable signal is present. ("Not Enabled" is displayed on the HIM) - Verify that Start signal is present. - Verify that Stop signal is present. - Verify that Run Forward and Run Reverse signals are NOT both active. (4) Check parameter mask settings <ul style="list-style-type: none"> - Verify that [Start Mask] is set properly. - Verify that [Logic Mask] is set properly. - Verify that [Local Mask] is set properly.
Drive Started but motor NOT rotating. ("At Speed 0.00 Hz" is displayed on HIM).	<ol style="list-style-type: none"> (1) Check motor <ul style="list-style-type: none"> - Verify that motor is connected properly. (2) Check Frequency Source <ul style="list-style-type: none"> - Verify that frequency signal is present at terminal block TB2. <ul style="list-style-type: none"> - 4-20mA signal - 0-10V signal - Remote Potentiometer - Verify that Adapter or Preset Frequencies are set properly. (3) Check control input signals. <ul style="list-style-type: none"> - Verify that SW1, SW2 and SW3 are in the proper state. (Refer to Table 5.A on page 5-23) (4) Check parameter settings and charts on Pages 5-26 and 5-27. <ul style="list-style-type: none"> - Verify that [Freq Source] is showing the desired frequency source. - Verify that [Freq Command] is the desired value. - Verify that [Reference Mask] is set properly.

Table 6.C Troubleshooting (cont.)

General Problem	Action to Take
Motor not accelerating properly.	(1) Check motor <ul style="list-style-type: none"> - Verify that motor is connected properly. - Verify that no mechanical problems exist. 2) Check control input signals <ul style="list-style-type: none"> - Verify that SW1, SW2, and SW3 are in the proper state to select desired Accel/Decel rates. (Refer to Table 5.A on page 5-23) (4) Check parameter settings and charts on Pages 5-26 and 5-27. <ul style="list-style-type: none"> - Verify that [Accel Time 1] and [Accel Time 2] are set properly. - Verify that [Current Limit] is set properly. - Verify that [DC Boost Select] is set correctly. - Verify that [Start Boost] and [Run Boost] are set properly.
Specific Problem	Action to Take
Can not JOG from Adapter.	(1) Verify that [JOG Mask] is set properly to allow jogging from that adapter. (2) Verify that [Logic Mask] is set properly to allow jogging from that adapter. (3) Is drive already running? (4) Examine [Stop Owner] to verify that a maintained Stop does not exist.
Can not change direction from Adapter.	(1) Verify that [Direction Mask] is set to allow direction changes from that adapter. (2) Verify that [Logic Mask] is set to allow direction changes from that adapter.
Can not Start from Adapter.	(1) Verify that [Start Mask] is set properly to allow starting from that adapter. (2) Verify that [Logic Mask] is set properly to allow starting from that adapter. (3) Is drive already running? (4) Examine [Stop Owner] to verify that a maintained Stop does not exist.
Display indicates "Not Enabled".	(1) Check enable signal at TB2, terminals 11 & 12.

Table 6.C Troubleshooting (cont.)

Specific Problem	Action to Take
Can not operate in "Run Fwd/Run Rev" mode.	(1) Verify that [Input Mode] is set correctly. (2) Has power been cycled for above change to take effect? (3) Are both Run Forward and Run reverse switches active?
Can not change speed from Adapter.	(1) Verify that the speed source is the adapter in question. (examine [Freq Source] parameter).
Can not operate drive without HIM.	(1) Verify that SW1, SW2, and SW3 are in the proper state to select the desired speed source. (Refer to charts on Pages 5-26 and 5-27) (2) Verify that [Freq Source] and [Freq Command] are desired values.
Drive faults when Adapter is unplugged.	(1) Verify that [Logic Mask] is set properly to allow removal of a particular Adapter while drive is powered up. (2) Verify that the adapter being unplugged is not the active frequency source.
Pin ID Error is displayed on HIM.	(1) Unplug the HIM from the cable or drive and re-connect.
"Network Error *" is displayed on the HIM.	(1) Press the "Up" or "Down" arrow to clear the message from the HIM display. (2) Unplug the HIM from the cable or drive and re-connect.
Can not clear fault from Adapter or Terminal Block with stop command.	(1) Verify that [Fault Clear Mode] is set to "Enabled" (2) Verify that [Fault Mask] is set to allow clearing of faults from chosen device. (3) Verify that [Logic Mask] is set properly.

This Page Intentionally Left Blank.

BLOCK DIAGRAM

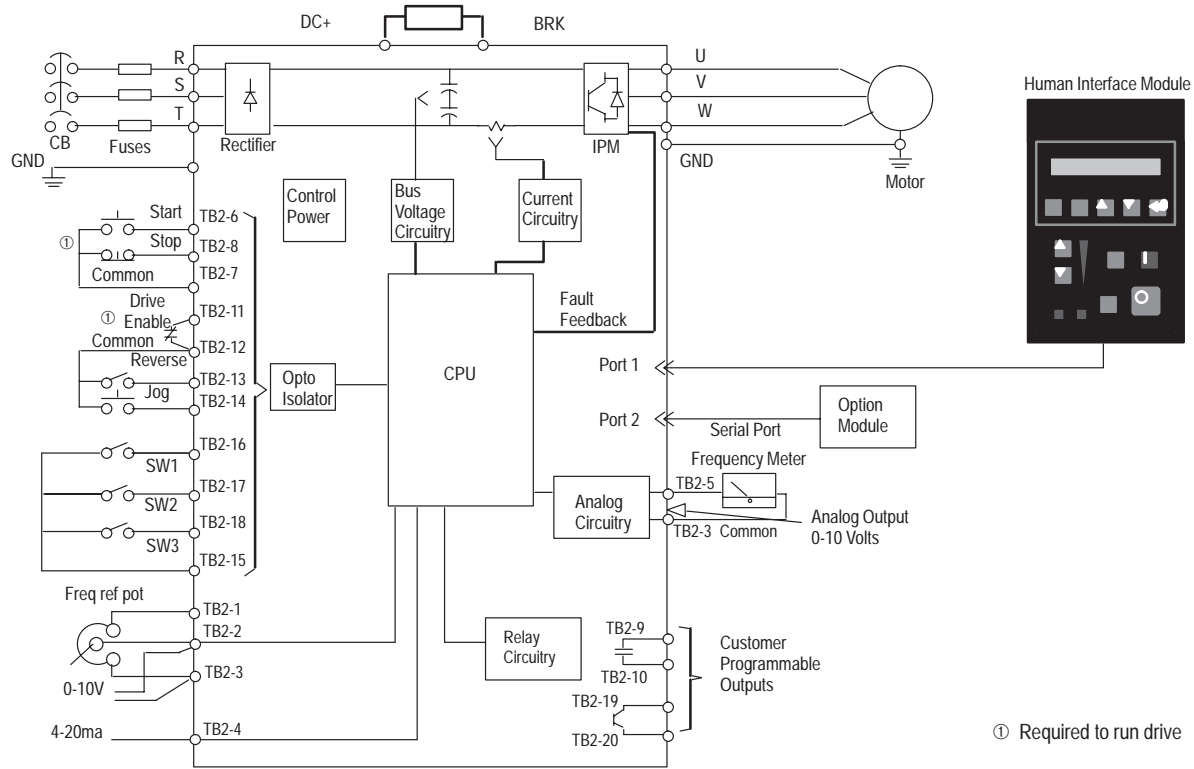


Table A.1 Specifications

Drive	Bulletin 1305 Drive Rated 200-230 V AC					Bulletin 1305 Drives Rated 380-460 V AC					
	-AA02A	-AA03A	-AA04A	-AA08A	-AA12A	-BA01A	-BA02A	-BA03A	-BA04A	-BA06A	-BA09A
OUTPUT RATINGS											
3 Phase Motor Rating kW (HP)	0.37 (1/2)	0.55 (3/4)	0.75 (1)	1.5 (2)	2.2 (3)	0.37 (1/2)	0.55 (3/4)	0.75 (1)	1.5 (2)	2.2 (3)	4.0 (5)
Output Current (A) ①	2.3	3.0	4.5	8.0	12.0 ②	1.3	1.6	2.3	4.0	6.0 ③	9.0 ④
Output Voltage	Adjustable from 0 V to Input Voltage										
Output Frequency (Hz)	0 to 400Hz Programmable										
INPUT RATINGS											
Input Voltage & Frequency	200/230V Three Phase, 50/60 Hz					380/460V Three Phase, 50/60 Hz					
Operational Range (V)	180-265V, 47-63 Hz					340V-500V, 47-63 Hz					
Input kVA	0.9	1.3	1.7	3.1	4.6	0.9	1.3	1.7	3.1	4.6	7.0
Power Factor (Displacement)	0.8 (Lagging)										
Efficiency (%)	97.5 % (Typical)										
Power Dissipation (W)	27	34	46	76	108	21	27	34	52	73	107

① If the **[PWM Frequency]** is set above 4kHz, the output current rating must be derated per the chart on page 5-18.

② Output current value listed for 200V input voltage. At 230V input voltage, output current is 9.6A for 3 phase.

③ Output current value listed for 380V input voltage. At 415V input voltage, output current is 5.3A. At 460V input voltage, output current is 4.8A.

④ Output current value listed for 380V input voltage. At 415V input voltage, output current is 8.4A. At 460V input voltage, output current is 7.6A.

Table A.1 Specifications (cont.)

ENVIRONMENTAL SPECIFICATIONS	
Enclosure	NEMA 1 (IP30) standard
Ambient Temperature	0 to 50°C; Optional Enclosures: 0 to 40°C
Storage Temperature	-40°C to 70°C
Relative Humidity	0 to 95% (non condensing)
Vibration	1.0 G Operational
Cooling Method	Natural Convection (no fans)
Altitude	Above 1,000 m (3,300 ft), derating at 6% of drive rated amps per 1000 m
CONTROL INPUTS	
Control Input Type	Contact closure (Internal 5V supply) DO NOT apply external voltage
Start Stop Forward/Reverse	Configurable Inputs for 2 or 3 wire control
Jog	Momentary (non-maintained) Input
SW1 SW2 SW3	Configurable Inputs for control of 7 Preset speeds and 2 Accel/Decel times
Enable	Interlock Input to enable drive operation
External Speed Potentiometer	10 K Ohms, 1 Watt
Analog Input (4 to 20mA)	Input Impedance 250 Ohms (Non-Isolated), 10 bit resolution
Analog Input (0 to 10 V DC)	Input Impedance 100 K Ohms (Non-Isolated), 10 bit resolution

Table A.1 Specifications (cont.)

CONTROL OUTPUTS											
Programmable Output 1	Form A Relay Contact: Resistive Rating 115V AC/ 30V DC, 5A; Inductive Rating 115V AC/ 30V DC, 2A										
Programmable Output 2	Open Collector (Sink): 24V DC, $\pm 20\%$, 50 mA maximum (User supplied source voltage)										
Analog Output (0 to 10V DC)	Load Impedance $\geq 4,000$ Ohms, 8 bit resolution										
PWM Algorithm	Sine Weighted PWM Output										
Switching Device 3-Phase Output	IGBT Intelligent Power Module										
V/Hz Ratio	Programmable										
Carrier Frequency	Adjustable in 100Hz Increments from 2 kHz to 8 kHz. Output Current Derating applies above 4 kHz.										
DC Boost	Adjustable single point or full custom – Start and Run boost available										
CONTROL FEATURES											
Drive	Bulletin 1305 Drive Rated 200-240 V AC					Bulletin 1305 Drives Rated 380-460 V AC					
	-AA02A	-AA03A	-AA04A	-AA08A	-AA12A	-BA01A	-BA02A	-BA03A	-BA04A	-BA06A	-BA09A
AC Dynamic Braking Torque - Estimated - Actual value will depend on motor characteristics											
W/O External Resistor	100%	100%	100%	50%	50%	100%	100%	100%	50%	50%	20%
With External Resistor	N/A	N/A	N/A	150%	100%	150%	150%	150%	150%	100%	100%
Current Limiting	Trip Free Operation, Co-ordinated for Drive and Motor Protection										
150% for 60 Seconds	Programmable from 20% to 150% of Drive Output Current										
200% for 2 seconds	Fixed by hardware, based on Drive Rating										

Table A.1 Specifications (cont.)

Motor Protection ^①	Electronic Overload Protection. Adjustable from 20% to 115% (Motor FLA)
Overload Pattern #0	Flat response over speed range (no current derating)
Overload Pattern #1	Current derating below 25% of Base Speed
Overload Pattern #2	Current derating below 50% of Base Speed
Accel/Decel Time(s)	0.1 to 3600 Seconds, independently set (2 Accel, 2 Decel)
Preset Speeds	0 to 400 Hz, 7 selections, independently set
Jog Input	0 to 400 Hz
Stopping Modes	4 modes programmable
Ramp to stop	0.1 to 3600 seconds
Coast	Stops all PWM Output
DC Brake to stop	Applies DC Voltage to the Motor for 0 to 15 seconds
S-Curve	Ramps to stop with S-Curve profile
PROTECTIVE FEATURES	
Excessive Temperature	Embedded temperature sensor trips if factory preset level is exceeded ^②
Over/Under Voltage	DC Bus voltage is monitored for safe operation
Power Ride Through	Minimum ride through 15mS under nominal conditions
Control Ride Through	Minimum ride through is 0.5 Seconds – typical value 2 seconds
Ground Short	Any output short to ground, detected prior to start
Line Voltage Transients	Inherent MOV (varistor) protection
Output Short Circuit	Inherent short circuit protection provided within IPM

^① See Page 5-12 for NEC and UL information.

^② Conditions such as ambient temperature, overload, duty cycle, etc. can affect tripping time.

Table A.1 Specifications (cont.)

PROGRAMMING/COMMUNICATIONS	
Adapters	The maximum current draw of all adapters connected to the drive should not exceed 250 mA
Hand Held Programming	Optional Human Interface Module (HIM can be removed from the Drive)
Type of Annunciation	Parameters displayed in textual form, organized in logical groupings
Type of Display	16 character, 2 line LCD supertwist with backlight
Language Capability	Multiple Languages available
Local Controls	3 versions available (Digital Pot., Analog Pot. and Blank)
Communication Adapters	Optional adapters provide Remote I/O, or RS232/422/485/DH485 or RS232/422/485/DF1 capability
MONITORING	
Output Frequency (Hz)	Displayed over the entire range of operation with direction indication
Output Voltage (V)	Selectable as a displayed parameter
Output Current (A)	Selectable as a displayed parameter in % or actual value
Output Power (kW)	Selectable as a displayed parameter in % or actual value
DC Bus Voltage (V)	Selectable as a displayed parameter
Frequency Command (Hz)	Selectable as a displayed parameter
Process Parameter	Any drive variable can be scaled and definable text can be added up to 8 characters
Drive Temperature °C	Selectable as a displayed parameter
Last Fault	The previous 4 faults can be displayed for troubleshooting

COMMUNICATIONS USING BULLETIN 1203 COMMUNICATION MODULES

Bulletin 1305 drive parameter data can be programmed and displayed using PLC's, SLC's or other logic controllers using an optional Bulletin 1203 Communication Module. The amount of information that can be transferred between the drive and controller is determined by the DIP switch settings on the Communication Module.

Table B.1 illustrates the dip switch settings for Bulletin 1203-GD1 (Remote I/O) communication modules. Dip switch settings for other communication modules will be similar. Refer to the appropriate communication module user manual for details.

IMPORTANT: Bulletin 1305 drives with firmware revisions FRN1.01 and FRN1.02 are not compatible with Bulletin 1203 Communication Modules. If connected, an error message will be indicated. The red fault status and amber SCANport™ status LED's on the front of the module will flash simultaneously.

SCANport is a trademark of Allen-Bradley Company.

Table B.1 Remote I/O Data Transfer

SW3 Settings	Type of Data Transferred	Rack Space in Words	Reference Information
No. 1	Block transfer of data	1	①
No. 2	Logic commands and Drive Status information	1	See Table B.2 & Table B.3
No. 3	Analog frequency reference	1	②
No. 4	Parameter data via Datalink A	2	See Page 5-49
No. 5	Parameter data via Datalink B	2	See Page 5-49
No. 6	Parameter data via Datalink C	2	See Page 5-49
No. 7	To transfer data via Datalink D	2	See Page 5-49
No. 8	Unused	--	--

- ① Refer to the *Bulletin 1203 Communication Module Block Transfer User Manual*.
- ② To enable the PLC to provide the frequency reference, Logic Bits 12 through 15 must be set to select **[Freq Select 1]** or **[Freq Select 2]** as the frequency reference (refer to Table B.2). The **[Freq Select 1]** or **[Freq Select 2]** parameters must then be set to the adapter number that the communication module is connected to. See Pages 2-21 and 5-23 for additional information on determining the Adapter number and **[Freq Select 1]** and **[Freq Select 2]** selections.

LOGIC CONTROL DATA

The information in Table B.2 provides the Logic Control information that is sent to the drive through the logic controllers output image table. When using the Bulletin 1203-GD1 communication module, this information is sent to the drive when dip switch No. 2 of SW3 is enabled.

DRIVE STATUS DATA

The information in Table B.3 provides the Drive Status information that will be sent to the logic controllers input image table from the drive. When using the Bulletin 1203-GD1 communication module this information will be sent to the PLC from the drive when switch No. 2 of SW3 is enabled.

PARAMETER GROUPS/USER SETTINGS

The information in Table B.4 provides a listing of all drive parameters.

The column entitled “Display Units” are the units that will appear on the Human Interface Module.

Since certain parameters have different resolution than others, a scale factor is required to convert the “Display Units” value to a decimal value that will be displayed in the controller’s I/O image tables. The column marked “Drive Units Scale Factor” is provided to perform this conversion.

SCALE FACTOR CONVERSION

When **Reading** parameter data in the controller’s input image table, divide this value by the “Drive Units Scale Factor” to determine the “Display Units.”

When **Writing** parameter data from the controller’s output image table to the drive, the value entered into the output image table should be the required “Display Units” value multiplied by the “Drive Units Scale Factor”.

“Display Unit” equivalent to Parameter Text Descriptions. Some parameters use a text description in the place of numerical “Display Units”. The information in Table B.5 provides the decimal equivalent to the text descriptions.

Table B.2 Logic Control Data

This information will be displayed in the controller’s output image table and will be sent to the drive when the appropriate dip switch setting on the Communication Module is enabled.

Logic Bits																Status	Text
15	14	13	12	11	10	9	8	7	6	5	4	3	2	1	0		
															X	Stop	1 = Stop, 0 = Not Stop
														X		Start	1 = Start, 0 = Not Start
													X			Jog	1 = Jog, 0 = Not Jog
												X				Clear Faults	1 = Clear Faults 0 = Not Clear Faults
										X	X					Direction	00 = No Command 10 = Reverse Command 01 = Forward Command 11 = Hold Direction Control
									X							Local	1 = Local Lockout, 0 = Not Local
								X								MOP Increment	1 = Increment, 0 = Not
						X	X									Accel Time	00 = No Commd 10 = Accel Time 2 Commd 01 = Accel Time 1 Commd 11 = Hold Accel Time Ctrl
				X	X											Decel Time	00 = No Commd Time 10 = Decel Time 2 Commd 01 = Decel Time 1 Commd 11 = Hold Time Ctrl
	X	X	X													Reference Select	000 = No Command Select 001 = [Freq Select 1] (Selectable) 010 = [Freq Select 2] (Selectable) 011 = [Preset Freq 3] 100 = [Preset Freq 4] 101 = [Preset Freq 5] 110 = [Preset Freq 6] 111 = [Preset Freq 7]
X																MOP Dec	1 = Decrement, 0 = Not

Table B.3 Drive Status Data

This information will be displayed in the controller’s input image table when the appropriate dip switch setting on the Communication Module is enabled.

Logic Bits															Status	Text	
15	14	13	12	11	10	9	8	7	6	5	4	3	2	1			0
															X	Enabled	1 = Enabled, 0 = Not Enabled
															X	Running	1 = Running, 0 = Not Running
													X			Command Direction	1 = Forward, 0 = Reverse
											X					Rotating Direction	1 = Forward, 0 = Reverse
										X						Accel	1 = Accelerating, 0 = Not
										X						Decel	1 = Decelerating, 0 = Not
									X							Alarm	1 = Alarm, 0 = No Alarm
								X								Fault	1 = Faulted, 0 = Not Faulted
						X										At Speed	1 = At Speed, 0 = NOT at Speed
				X	X	X										Local	000 = TB2 Local 100 = Adapter 4 Local 001 = Adapter 1 Local 101 = Adapter 5 Local 010 = Adapter 2 Local 110 = Adapter 6 Local 011 = Adapter 3 Local 111 = No Local Control
X	X	X	X													Frequency Reference	0000 = Freq Select 1 1000 = Freq Select 2 0001 = Preset Freq 1 1001 = Port 1 Adapter 1 0010 = Preset Freq 2 1010 = Port 2 Adapter 2 0011 = Preset Freq 3 1011 = Port 3 Adapter 3 0100 = Preset Freq 4 1100 = Port 4 Adapter 4 0101 = Preset Freq 5 1101 = Port 5 Adapter 5 0110 = Preset Freq 6 1110 = Port 6 Adapter 6 0111 = Preset Freq 7 1111 = Jog Frequency

Table B.4 Parameter Grouping/User Settings

Group	Parameter Name	Parameter #	Display Units	Drive Units Scale Factor ②	Min	Max	Factory Setting	User's Setting
Metering	Output Current	54	Amps	100	0.00	Two times drive output current	--	
	Output Voltage	1	Volts	100	0	Maximum Voltage	--	
	Output Power	23	kW	100	0.00	Two times rated drive output power	--	
	DC Bus Voltage	53	Volts	1	0	410 - 230V Drive 815 - 460V Drive	--	
	Output Freq	66	Hz	32767 = Max. Freq	0.00	Maximum Frequency	--	
	Freq Command	65	Hz	100	0.00	400.00	0.00	
	MOP Hz	42	Hz	100	0.00	400.00	0.00	
	Drive Temp	70	° C	1	0	Drive temperature	--	
	Last Fault	4	0	1	0	Max. Fault Number	--	
	% Output Power	3	%	1	0	200% Drive Rated Power	--	
% Output Curr	2	%	1	0	200% of Rated Drive Output Current	--		

① Refer to Table B.5 on pages B-13, B-14 and B-15 for the numerical equivalent of the text descriptions. ② Refer to page B-2.

Table B.4 Parameter Grouping/User Settings (cont.)

Group	Parameter Name	Parameter #	Display Units	Drive Units Scale Factor ②	Min	Max	Factory Setting	User's Setting
Set Up	Input Mode	21	Text ①	1	---	---	Three Wire	
	Freq Select 1	5	Text ①	1	---	---	Adapter 1	
	Accel Time 1	7	Seconds	10	0.0	3600.0	10.0	
	Decel Time 1	8	Seconds	10	0.0	3600.0	10.0	
	Base Frequency	17	Hz	1	40	400	60	
	Base Voltage	18	Volts	1	25% of DRV	Drive Rated Volts	Drive Rated Volts	
	Maximum Voltage	20	Volts	1	25% of DRV	Drive Rated Volts	Drive Rated Volts	
	Minimum Freq	16	Hz	1	0	120	0	
	Maximum Freq	19	Hz	1	40	400	60	
	Stop Select	10	Text ①	1	---	---	Ramp	
	Current Limit	36	%	1	20% of DRC	150% of Drive Rated Current (DRC)	150% of DRC	
	Overload Mode	37	Text ①	1	---	---	No Derating	
Overload Current	38	Amps	100 = DRC	20% of DRC	115% of Drive Rated Current (DRC)	115% of DRC		
Sec Curr Limit	141	%	1	0	150% of Drive Rated Current (DRC)	0		

① Refer to Table B.5 on pages B-13, B-14 and B-15 for the numerical equivalent of the text descriptions. ② Refer to page B-2.

Table B.4 Parameter Grouping/User Settings (cont.)

Group	Parameter Name	Parameter #	Display Units	Drive Units Scale Factor ②	Min	Max	Factory Setting	User's Setting
Advanced Set Up	Minimum Freq	16	Hz	1	0	120	0	
	Maximum Freq	19	Hz	1	40	400	60	
	Base Frequency	17	Hz	1	40	400	60	
	Base Voltage	18	Volts	1	25% of DRV	Maximum Drive Rated Volts	Maximum DRV	
	Break Frequency	49	Hz	1	0	120	0	
	Break Voltage	50	Volts	1	0	50% of Max Drive Rated Volts	0	
	Maximum Voltage	20	Volts	1	25% of DRV	Maximum Drive Rated Volts	Maximum DRV	
	DC Boost Select	9	Text ①	1	--	--	No Boost	
	Start Boost	48	Volts	1	0	25% of Max. Drive Rated Volts	0	
	Run Boost	83	Volts	1	0	25% of Max. Drive Rated Volt	0	
	PWM Frequency	45	kHz	10	2.0	8.0	4.0	
	Analog Invert	84	Text ①	1	--	--	Disabled	
	4–20 mA Loss Sel	81	Text ①	1	--	--	Stop/Fault	
	Stop Select	10	Text ①	1	--	--	Ramp	
	DC Hold Time	12	Seconds	1	0	15	0	
	DC Hold Level	13	Volts	1	0	25% of Max. Drive Rated Volt	0	
	DB Enable	11	Text ①	1	--	--	Disabled	
Motor Type	41	Text ①	1	--	--	Induc/Reluc		
Compensation	52	Text ①	1	--	--	No Comp		

① Refer to Table B.5 on pages B-13, B-14 and B-15 for the numerical equivalent of the text descriptions. ② Refer to page B-2.

Table B.4 Parameter Grouping/User Settings (cont.)

Group	Parameter Name	Parameter #	Display Units	Drive Units Scale Factor ②	Min	Max	Factory Setting	User's Setting
Frequency Set	Freq Select 1	5	Text ①	1	--	--	Adapter 1	
	Freq Select 2	6	Text ①	1	--	---	Remote Pot	
	Jog Frequency	24	Hz	100	0	400.0	10.0	
	Prst/2nd Accel	26	Text ①	1	--	--	Preset	
	Upper Presets	72	Text ①	1	--	--	Disabled	
	Accel Time 2	30	Seconds	10	0.0	3600.0	10.0	
	Decel Time 2	31	Seconds	10	0.0	3600.0	10.0	
	Preset Freq 1 ③	27	Hz	100	0.0	400.0	0.0	
	Preset Freq 2 ③	28	Hz	100	0.0	400.0	0.0	
	Preset Freq 3 ③	29	Hz	100	0.0	400.0	0.0	
	Preset Freq 4 ③	73	Hz	100	0.0	400.0	0.0	
	Preset Freq 5 ③	74	Hz	100	0.0	400.0	0.0	
	Preset Freq 6 ③	75	Hz	100	0.0	400.0	0.0	
	Preset Freq 7 ③	76	Hz	100	0.0	400.0	0.0	
	Skip Freq 1	32	Hz	1	0	400	400	
	Skip Freq 2	33	Hz	1	0	400	400	
	Skip Freq 3	34	Hz	1	0	400	400	
	Skip Freq Band	35	Hz	1	0	15	0	
	MOP Increment	22	Hz/Second	1	0.00	255.00	0.00	

① Refer to Table B.5 on pages B-13, B-14 and B-15 for the numerical equivalent of the text descriptions.

② Refer to page B-2.

③ Not accessible with data links [Data In A1] through [Data Out D2].

Table B.4 Parameter Grouping/User Settings (cont.)

Group	Parameter Name	Parameter #	Display Units	Drive Units Scale Factor ②	Min	Max	Factory Setting	User's Setting
Feature Select	Run On Power Up	14	Text ①	1	--	--	Disabled	
	Reset/Run Tries	85	Numeric	1	0	9	0	
	Reset/Run Time	15	Seconds	100	0.5	30.0	1.0	
	S Curve Enable	57	Text ①	1	--	---	Disabled	
	S Curve Time	56	Seconds	10	0.0	300.0	0.0	
	Language	47	Text ①	1	--	---	English	
	Balance Freq	80	Hz	1	0	255	0	
	Balance Time	79	Seconds	1	0	255	0	
Balance Angle	78	Numeric	1	0	255	0		
Output Set Up	Output Config 1	90	Text ①	1	--	--	Faulted	
	Output Config 2	91	Text ①	1	--	--	Running	
	Analog Out Sel	25	Text ①	1	--	--	Frequency	
	Above Freq Val	77	Hz	1	0	400	0	
Faults	Fault Buffer 0	86	Numeric	1	--	--	--	
	Fault Buffer 1	87	Numeric	1	--	--	--	
	Fault Buffer 2	88	Numeric	1	--	--	--	
	Fault Buffer 3	89	Numeric	1	--	--	--	
	Clear Fault	51	Text ①	1	--	--	Ready	
	Cur Lim Trip En	82	Text ①	1	--	--	Default Run	
	Line Loss Fault	40	Text ①	1	--	--	F03 Enable	
Fault Clear Mode	39	Text ①	1	--	--	Enabled		

① Refer to Table B.5 on pages B-13, B-14 and B-15 for the numerical equivalent of the text descriptions.

② Refer to page B-2.

Table B.4 Parameter Grouping/User Settings (cont.)

Group	Parameter Name	Parameter #	Display Units	Drive Units Scale Factor ②	Min	Max	Factory Setting	User's Setting
Diagnostics	Drive Command	58	Byte	--	--	--	--	
	Drive Status	59	Word	--	--	--	--	
	Drive Alarm	60	Byte	--	--	--	--	
	Input Status	55	Byte	--	--	--	--	
	Freq Source	62	Text ①	1	--	--	--	
	Freq Command	65	Hz	100	- 0.00	400.00	0.00	
	Drive Direction	69	Text	1	--	--	Forward	
	Motor Mode	43	Text	1	--	--	--	
	Power Mode	44	Text	1	--	--	--	
	Drive Type	61	Text	1	--	--	--	
	Firmware Version	71	Numeric	1	--	--	--	
	Output Pulses	67	Cycles	256=1 rev	0	65535	--	
	Drive Temp	70	°C	1	0	Drive Temperature		
	Set Defaults	64	Numeric	1	--	--	Ready	
Masks	Logic Mask	92	Byte	--	--	--	01111111	
	Direction Mask	94	Byte	--	--	--	01111111	
	Start Mask	95	Byte	--	--	--	01111111	
	Jog Mask	96	Byte	--	--	--	01111111	
	Reference Mask	97	Byte	--	--	--	01111111	
	Accel Mask	98	Byte	--	--	--	01111111	
	Decel Mask	99	Byte	--	--	--	01111111	
	Fault Mask	100	Byte	--	--	--	01111111	
	MOP Mask	101	Byte	--	--	--	01111111	
Local Mask	93	Byte	--	--	--	01111111		

① Refer to Table B.5 on pages B-13, B-14 and B-15 for the numerical equivalent of the text descriptions. ② Refer to page B-2.

Table B.4 Parameter Grouping/User Settings (cont.)

Group	Parameter Name	Parameter #	Display Units	Drive Units Scale Factor ①	Min	Max	Factory Setting	User's Setting
Owners	Stop Owner	102	Byte	--	--	--	--	
	Direction Owner	103	Byte	--	--	--	--	
	Start Owner	104	Byte	--	--	--	--	
	Jog Owner	105	Byte	--	--	--	--	
	Reference Owner	106	Byte	--	--	--	--	
	Accel Owner	107	Byte	--	--	--	--	
	Decel Owner	108	Byte	--	--	--	--	
	Fault Owner	109	Byte	--	--	--	--	
	MOP Owner	110	Byte	--	--	--	--	
Local Owner	137	Byte	--	--	--	--		
Adapter I/O	Data In A1	111	Parameter # ②	1	0	142	0	
	Data In A2	112	Parameter # ②	1	0	142	0	
	Data In B1	113	Parameter # ②	1	0	142	0	
	Data In B2	114	Parameter # ②	1	0	142	0	
	Data In C1	115	Parameter # ②	1	0	142	0	
	Data In C2	116	Parameter # ②	1	0	142	0	
	Data In D1	117	Parameter # ②	1	0	142	0	
	Data In D2	118	Parameter # ②	1	0	142	0	
	Data Out A1	119	Parameter # ②	1	0	142	1	
	Data Out A2	120	Parameter # ②	1	0	142	1	
	Data Out B1	121	Parameter # ②	1	0	142	1	
	Data Out B2	122	Parameter # ②	1	0	142	1	
	Data Out C1	123	Parameter # ②	1	0	142	1	
	Data Out C2	124	Parameter # ②	1	0	142	1	
Data Out D1	125	Parameter # ②	1	0	142	1		
Data Out D2	126	Parameter # ②	1	0	142	1		

① Refer to page B-2.

② [Preset Freq 1] through [Preset Freq 7] cannot be read or changed with these parameters.

Table B.4 Parameter Grouping/User Settings (cont.)

Group	Parameter Name	Parameter #	Display Units	Drive Units Scale Factor ②	Min	Max	Factory Setting	User's Setting
Process Display	Process Par	127	Parameter #	1	1	255	1	
	Process Scale	128	Numeric	100	-327.68	+327.67	1.00	
	Process Text 1	129	ASCII Text	--	--	--	?	
	Process Text 2	130	ASCII Text	--	--	--	--	
	Process Text 3	131	ASCII Text	--	--	--	--	
	Process Text 4	132	ASCII Text	--	--	--	--	
	Process Text 5	133	ASCII Text	--	--	--	--	
	Process Text 6	134	ASCII Text	--	--	--	--	
	Process Text 7	135	ASCII Text	--	--	--	--	
Process Text 8	136	ASCII Text	--	--	--	--		

① Refer to Table B.5 on pages B-13, B-14 and B-15 for the numerical equivalent of the text descriptions.

② Refer to page B-2.

Table B.5 “Display Unit” Equivalent to Parameter Text Descriptions

Parameter No.	Parameter Name	Text	Display Unit
5	Freq Select 1	“Remote Pot”	1
6	Freq Select 2	“0-10 Volt”	2
62	Freq Source	“4-20 mA”	3
		“MOP”	4
		“Adapter 1”	5
		“Adapter 2 ”	6
		“Adapter 3”	7
		“Adapter 4”	8
		“Adapter 5”	9
		“Adapter 6”	10
		“Preset 1”	11
		“Preset 2”	12
		“Preset 3”	13
		“Preset 4”	14
		“Preset 5”	15
		“Preset 6”	16
		“Preset 7”	17
		“Jog Sel ”	18

Parameter No.	Parameter Name	Text	Display Unit
9	DC Boost Select	“Fan Sel #1”	0
		“Fan Sel #2”	1
		“No Boost”	2
		“6 volts”	3
		“12 volts”	4
		“18 volts”	5
		“24 volts”	6
		“30 volts”	7
		“36 volts”	8
		“42 volts”	9
		“48 volts”	10
		“Break Point”	11
“Run Boost”	12		
10	Stop Select	“Coast”	0
		“DC Brake”	1
		“S-Curve”	3
		“Ramp”	2

Table B.5 “Display Unit” Equivalent to Parameter Text Descriptions (continued)

Parameter No.	Parameter Name	Text	Display Unit
11	DB Enabled	“Disabled”	0
		“Enabled”	1
14	Run On Power Up	Disabled	0
		Enabled	1
21	Input Mode	“Three Wire”	0
		“Run Fwd/Rev”	1
25	Analog Out Sel	“Frequency”	0
		“Current”	1
		“BusVolts”	2
		“Power”	3
26	Preset/2nd Accel	“Preset”	0
		“2nd Accel”	1
37	Overload Mode	“No Derating”	0
		“Min Derate”	1
		“Max Derate”	2
39	Fault Clear Mode	Disabled	0
		Enabled	1

Parameter No.	Parameter Name	Text	Display Unit
40	Line Loss Fault	“F03 Enable”	0
		“Uvolt Run”	1
41	Motor Type	“Induc/Reluc”	0
		“Sync PM”	1
43	Motor Mode	“Invalid”	0
		“Zero Mode”	1
		“Accel Mode”	2
		“At Hz Mode”	3
		“Decel Mode”	4
		“Coast Mode”	5
		“Braking Mode”	6
“Faulted Mode”	7		
44	Power Mode	“Invalid”	0
		“First Mode”	1
		“Charge Mode”	2
		“Wait Mode”	3
		“Test Mode”	4
		“LineLoss Mode”	5
		“Idle Mode”	6

Table B.5 “Display Unit” Equivalent to Parameter Text Descriptions (continued)

Parameter No.	Parameter Name	Text	Display Unit
44	Power Mode (continued)	“Active Mode”	7
		“Braking Mode”	8
		“Faulted Mode”	9
47	Language	“English”	0
		“Alternate Language”	1
51	Clear Fault	“Ready”	0
		“Clear Fault”	1
52	Compensation	“No Comp.”	0
		“Comp.”	1
57	S-Curve Enable	Disabled	0
		Enabled	1
64	Set Defaults	“Ready”	0
		“Store to EE”	1
		“Recll frm EE”	2
		“Default Init”	3
69	Drive Direction	“Forward”	0
		“Reverse”	1
72	Upper Presets	Disabled	0
		Enabled	1
81	4-20mA Loss Sel	“Min/Alarm”	0
		“Stop/Fault”	1
		“Hold/Alarm”	2
		“Max/Alarm”	3
		“Pre1/Alarm”	4
82	Curr Lim Trip En	“Default Run”	0
		“Trip @ I Lmt”	1
84	Analog Invert	Disabled	0
		Enabled	1
90	Output Config 1	“At Speed”	0
91	Output Config 2	“Above Freq”	1
		“Running”	2
		“Faulted”	3
		“Alarm”	4
		“Balanced”	5
		“Above Curr”	6

This Page Intentionally Left Blank.

ACCESSORIES

Table C.1

Bulletin 1201 Descriptions	Use With	NEMA Type 1 IP30 Cat. No.
Door Mount Bezel Kit	Bulletin 1305 Drives	1201-DMA
Blank Cover		1201-HAB
Human Interface Module – Programmer Only		1201-HAP
Human Interface Module – Analog Speed Potentiometer		1201-HA1
Human Interface Module – Digital Up–Down Speed Control		1201-HA2
Bulletin 1202 Descriptions	Use With	Cat. No.
1/3 Meter Communication Cable (Male-Male) for Port 2	Human Interface Module and Communications Modules	1202-C03
1 Meter Communication Cable (Male-Male) for Port 2		1202-C10
3 Meter Communication Cable (Male-Male) for Port 2		1202-C30
9 Meter Communication Cable (Male-Male) for Port 2		1202-C90
1/3 Meter Communication Cable (Male-Female) for Port 1	Human Interface Module Only	1202-H03
1 Meter Communication Cable (Male-Female) for Port 1		1202-H10
3 Meter Communication Cable (Male-Female) for Port 1		1202-H30
9 Meter Communication Cable (Male-Female) for Port 1		1202-H90
Bulletin 1203 Descriptions	Use With	Cat. No.
Single Point Remote I/O Communication Module ①	Bulletin 1305 Drives	1203-GD1/GK1
RS232/RS422/RS485/DF1/DH485 Serial Communication Module ①		1203-GD2/GK2
DeviceNet™ Communication Module ②		1203-GK5

① Separately powered AC/DC.

② Separately powered DC only.

Table C.2 Accessories

Accessory	Specifications
Line Reactor	Iron core, 3% Impedance, 600V, Class H insulation, 115°C rise, copper wound, 50/60 Hz, terminal blocks, UL, CSA
Isolation Transformer	230V/230V or 460V/460V, Delta primary/Wye secondary, Class H insulation, 150°C rise, aluminum wound, 60 Hz, ± 5% taps, (1) N.C. thermostat per coil, UL, CSA

Drive Output Ratings		Input Line Reactors		Isolation Transformer
HP	kW	Open Style	NEMA Type 1	NEMA Type 1
240V AC				
1/2	0.37	1321-3R4-A	1321-3RA4-A	1321-3T003-AA
3/4	0.55	1321-3R4-A	1321-3RA4-A	1321-3T003-AA
1	0.75	1321-3R8-A	1321-3RA8-A	1321-3T005-AA
2	1.5	1321-3R8-A	1321-3RA8-A	1321-3T005-AA
3	2.2	1321-3R18-A	1321-3RA18-A	1321-3T005-AA
460V AC				
1/2	0.37	1321-3R2-B	1321-3RA2-B	1321-3T003-BB
3/4	0.55	1321-3R2-B	1321-3RA2-B	1321-3T003-BB
1	0.75	1321-3R4-B	1321-3RA4-B	1321-3T005-BB
2	1.5	1321-3R4-B	1321-3RA4-B	1321-3T005-BB
3	2.2	1321-3R8-B	1321-3RA8-B	1321-3T005-BB
5	4.0	1321-3R18-B	1321-3RA18-B	1321-3T007-BB

Drive Output Ratings		Dynamic Brake Kits ①
HP	kW	
230V AC		
2	1.5	1305-KAA12
3	2.2	1305-KAA12
460V AC		
1/2	0.37	1305-KBA03
3/4	0.55	1305-KBA03
1	0.75	1305-KBA03
2	1.5	1305-KBA06
3	2.2	1305-KBA06
5	4	1305-KBA09

① *[DB Enable] should be set to "Enable" when applying external dynamic brake kits.*

A

AC Input Wiring, 2-11
Accel/Decel Control, 5-8, 5-9, 5-25,
5-27, 5-28
Accessories, C-1
Adapters, 2-20
Ambient Temperature, A-3
Analog Input
0-10V, 2-17, A-3
4-20mA, 2-17, 5-21, A-3
Analog Invert, 5-21
Analog Output, 2-17, 5-35, A-4
Auto Restart, 5-30

B

Block Diagram, A-1
Brake, 5-11, 5-23, B-6, B-12, B-13

C

Cable Termination, 2-19
Carrier Frequency, 5-20, A-4
Catalog Number Description, 1-5
Choose Mode, 3-5, 3-6
Clearing Faults, 5-36, 5-37, 6-1
Control Panel
Analog Speed Potentiometer, 3-3
Direction Indicators (LEDs), 3-3
Speed Indicator, 3-3
Control Panel Keys
Change Direction, 3-3
Increment/Decrement, 3-3

Jog, 3-2

Start, 3-2
Stop, 3-2

Control Status Mode, 3-5, 3-14
Conventions Used in Manual, 1-3
Current Limiting, 5-12, 5-13, 5-36
Current Rating, 1-5
Custom Volts/Hertz Patterns, 5-16, 5-17, 5-18

D

DC Brake to Stop, 5-11, 5-23
DC Hold Level, 5-23
Diagnostics Group, 5-38
Dimensions, 2-2
Display Mode, 3-5, 3-7
Display Panel Keys
Enter, 3-2
Escape, 3-2
Increment/Decrement, 3-2
Select, 3-2
Distances between Devices, 2-1, 2-21
Drive Temperature, 5-7, 5-42
Dynamic Brake, 2-11

E

EEProm Mode, 3-5, 3-10
Drive—>HIM, 3-11
HIM—>Drive, 3-12
Electrical Interference, 2-7
Enable Signal, 2-17
ESD, Electrostatic Discharge, 1-1

F

Fan/Pump Volts/Hz Patterns, 5-18
Fault Buffer History, 5-36
Faults
Diag C Lim Fault, 6-3, 6-4
Drive Reset Fault, 6-3
EEProm Fault, 6-3
Hertz Err Fault, 6-3
Hertz Set Fault, 6-3
IPM Current Fault, 6-4
IPM Overtemp Fault, 6-4
Max Retries Fault, 6-4
Motor Mode Fault, 6-5
Motor Stall Fault, 6-5
Neg Slope Fault, 6-5
Op Error Fault, 6-5, 6-6
Open Pot Fault, 6-6
Overcurrent Fault, 6-6
Overload Fault, 6-6
Overspeed Fault, 6-6
Overtemp Fault, 6-6
Overvolt Fault, 6-6
Phase U Fault, 6-7
Phase V Fault, 6-7
Phase W Fault, 6-7
Power Loss Fault, 6-7
Power Mode Fault, 6-7
Reprogram Fault, 6-7
Run Boost Fault, 6-7
Serial Fault, 6-8

Undervolt Fault, 6-8
UV Short Fault, 6-8
UW Short Fault, 6-8
VW Short Fault, 6-8
Firmware Compatibility, 1-4
Frequency Select, 5-24, 5-27, 5-28
Fusing, AC Input, 2-6

G

Grounding, 2-9, 2-11, 2-17
Group Level, 3-6

H

HIM

Control Panel, 3-1
Display Panel, 3-1
Installation, 3-4
Key Descriptions, 3-2
Removal, 3-4

HIM Modes

Control Status, 3-5, 3-14
Display, 3-5, 3-7
EEProm, 3-5, 3-10
Password, 3-5, 3-16
Process, 3-5, 3-9
Program, 3-5, 3-7
Search, 3-5, 3-13

Human Interface Module

See also HIM
Key Descriptions, 3-2
Removal, 3-4

Human Interface Module (HIM),
Description, 3-1

I

Input Devices, 2-5
Input Fusing, 2-6
Input Mode Selection, 2-15
Input Power Conditioning, 2-6
Isolation Transformer, 2-6

J

Jog, 5-25, 5-44

L

Language, 1-5, 5-32

LEDs

Direction Indicators, 3-3
Speed Indicator, 3-3

Levels

Group, 3-6
Mode, 3-6
Operator, 3-6
Parameter, 3-6

Line Reactor, 2-6

Low Line Operation, 5-36, 5-37

M

Min/Max Frequencies, 5-10

Mode Level, 3-6

Modes, Choose, 3-5, 3-6

See also HIM Modes

Motor Unbalance, 5-33

Mounting, 2-1

N

Nameplate Location, 1-4

O

Operator Level, 3-6
Output Contacts, 5-34, 5-35, A-5
Output Devices, 2-19
Output Disconnection, 2-6
Output Ratings, 1-5, A-2
Overload Protection, 5-12

P

Parameter Level, 3-6

Parameters

% Output Current, 5-7
% Output Power, 5-7
4-20mA Loss Sel, 5-21
Above Curr Val, 5-35
Above Freq Val, 5-35
Accel Mask, 5-44
Accel Owner, 5-49
Accel Time 1, 5-8
Accel Time 2, 5-25
Adapter I/O, 5-51
Advanced Setup Group, 5-15
Analog Invert, 5-21
Analog Out Sel, 5-35
Balance Angle, 5-33
Balance Freq, 5-33

- Balance Time, 5-33
- Base Frequency, 5-9, 5-15
- Base Voltage, 5-9, 5-16
- Break Frequency, 5-16
- Break Voltage, 5-17
- Clear Fault, 5-36
- Compensation, 5-23
- Current Lim Trip En, 5-36
- Current Limit, 5-11
- Data In A1, 5-51
- Data Out A1, 5-52
- DB Enable, 5-23
- DC Boost Select, 5-18
- DC Bus Voltage, 5-5
- DC Hold Level, 5-23
- DC Hold Time, 5-22
- Decel Mask, 5-44
- Decel Owner, 5-49
- Decel Time 1, 5-9
- Decel Time 2, 5-26
- Diagnostics Group, 5-38
- Direction Mask, 5-43
- Direction Owner, 5-47
- Drive Alarm, 5-40
- Drive Command, 5-38
- Drive Direction, 5-41
- Drive Status, 5-39
- Drive Temp, 5-7, 5-42
- Drive Type, 5-42
- Fault Buffer 0-3, 5-36
- Fault Clear Mode, 5-37
- Fault Mask, 5-45
- Fault Owner, 5-49
- Faults Group, 5-36
- Feature Select, 5-30
- Firmware Ver, 5-42
- Freq Command, 5-6, 5-41
- Freq Select 1, 5-8, 5-24
- Freq Select 2, 5-24
- Freq Source, 5-41
- Frequency Set Group, 5-24
- Input Mode, 5-8
- Input Status, 5-40
- Jog Frequency, 5-25
- Jog Mask, 5-44
- Jog Owner, 5-48
- Language, 5-32
- Last Fault, 5-7
- Line Loss Fault, 5-36
- Local Mask, 5-45
- Local Owner, 5-50
- Logic Masks, 5-43
- Masks Group, 5-43
- Maximum Frequency, 5-15
- Maximum Voltage, 5-10, 5-17
- Minimum Frequency, 5-10, 5-15
- MOP Hertz, 5-6
- MOP Increment, 5-29
- MOP Mask, 5-45
- MOP Owner, 5-50
- Motor Mode, 5-41
- Motor Type, 5-23
- Output 1 Config, 5-34
- Output 2 Config, 5-34
- Output Configuration Group, 5-34
- Output Current, 5-5
- Output Frequency, 5-6
- Output Power, 5-5
- Output Pulses, 5-42
- Output Voltage, 5-5
- Overload Current, 5-12
- Overload Mode, 5-12
- Owners, 5-47
- Power Mode, 5-42
- Preset Freq 1-7, 5-26
- Process 1 Par, 5-53
- Process 1 Scale, 5-53
- Process Display Group, 5-53, 5-54
- Process Txt 1-8, 5-53
- Prst/2nd Accel, 5-25
- PWM Frequency, 5-20
- Reference Mask, 5-44
- Reference Owner, 5-49
- Reset/Run Time, 5-30
- Reset/Run Tries, 5-30
- Run Boost, 5-19
- Run On Power Up, 5-30
- S Curve Enable, 5-31
- S Curve Time, 5-32
- Sec Current Limit, 5-13

- Set Defaults, 5-42
- Setup Group, 5-8
- Skip Frequency Band, 5-29
- Skip Frequency Group 1-3, 5-26
- Start Boost, 5-19
- Start Mask, 5-44
- Start Owner, 5-48
- Stop Owner, 5-47
- Stop Select, 5-11, 5-22
- Upper Presets, 5-25
- Password Mode, 3-5, 3-16
- Potentiometer Wiring, 2-17, 2-18
- Power, 2-11
- Power Dissipation, A-2
- Preset Frequencies, 5-25, 5-26, 5-27, 5-28
- Process Display, 5-53, 5-54
- Process Mode, 3-5, 3-9
- Program Mode, 3-5, 3-7
- Programming
 - Function Index, 5-1
 - Using a HIM, 5-1
 - Programming Steps, 5-2, 5-4
- R**
- Reverse, 2-16
- RFI Filtering, 2-8
- S**
- S-Curve, 5-31, 5-32
- Search Mode, 3-5, 3-13
- Set Defaults, 5-42
- Skip Frequencies, 5-26
- Specifications
 - Control, A-3
 - Environment, A-3
 - Input/Output Ratings, A-2
 - Protection, A-5
- Start-Up, 4-1
 - Procedure, 4-1
- Status Display, 3-5
- Stopping, 5-11, 5-21
- Storage Temperature, A-3
- Switch Settings
 - Accel/Decel, 5-28
 - Frequency Selections, 5-27
- T**
- TB1, 2-11
- TB2, 2-17
- Three Wire Control, 2-16
- Troubleshooting, 6-1
- Two Wire Control, 2-15
- V**
- Vibration, A-3
- Voltage Boost, 5-18, 5-19
- Voltage Rating, 1-5
- W**
- Wiring, Control and Signal, 2-15, 2-17



Allen-Bradley, a Rockwell Automation Business, has been helping its customers improve productivity and quality for more than 90 years. We design, manufacture and support a broad range of automation products worldwide. They include logic processors, power and motion control devices, operator interfaces, sensors and a variety of software. Rockwell is one of the world's leading technology companies.



Worldwide representation.

Argentina • Australia • Austria • Bahrain • Belgium • Brazil • Bulgaria • Canada • Chile • China, PRC • Colombia • Costa Rica • Croatia • Cyprus • Czech Republic • Denmark • Ecuador • Egypt • El Salvador • Finland • France • Germany • Greece • Guatemala • Honduras • Hong Kong • Hungary • Iceland • India • Indonesia • Ireland • Israel • Italy • Jamaica • Japan • Jordan • Korea • Kuwait • Lebanon • Malaysia • Mexico • Netherlands • New Zealand • Norway • Pakistan • Peru • Philippines • Poland • Portugal • Puerto Rico • Qatar • Romania • Russia-CIS • Saudi Arabia • Singapore • Slovakia • Slovenia • South Africa, Republic • Spain • Sweden • Switzerland • Taiwan • Thailand • Turkey • United Arab Emirates • United Kingdom • United States • Uruguay • Venezuela • Yugoslavia

Allen-Bradley Headquarters, 1201 South Second Street, Milwaukee, WI 53204 USA, Tel: (1) 414 382-2000 Fax: (1) 414 382-4444

Publication 1305-5.0 November, 1995
Supersedes Publication 1305-5.0 June, 1995

40052-379-01(F)

Copyright 1994 Allen-Bradley Company, Inc., a Rockwell International company Printed in USA