



[efesotomasyon.com](http://efesotomasyon.com)

***Allen-Bradley***

***1305 Adjustable  
Frequency AC Drive  
(Series C)***

***0.37 - 4 kW (0.5 - 5 HP)  
FRN 6.01 and Up***

# **User Manual**

## PLEASE READ!

This manual is intended to guide qualified personnel in the installation and operation of this product.

Because of the variety of uses for this equipment and because of the differences between this solid-state equipment and electromechanical equipment, the user of and those responsible for applying this equipment must satisfy themselves as to the acceptability of each application and use of the equipment. In no event will Allen-Bradley Company be responsible or liable for indirect or consequential damages resulting from the use or application of this equipment.

The illustrations shown in this manual are intended solely to illustrate the text of this manual. Because of the many variables and requirements associated with any particular installation, the Allen-Bradley Company cannot assume responsibility or liability for actual use based upon the illustrative uses and applications.

No patent liability is assumed by Allen-Bradley Company with respect to use of information, circuits or equipment described in this text.

Reproduction of the content of this manual, in whole or in part, without written permission of the Allen-Bradley Company is prohibited.

## IMPORTANT USER INFORMATION

The information in this manual is organized in numbered chapters. Read each chapter in sequence and perform procedures when you are instructed to do so. Do not proceed to the next chapter until you have completed all procedures.

Throughout this manual we use notes to make you aware of safety considerations:



**ATTENTION:** Identifies information about practices or circumstances that can lead to personal injury or death, property damage or economic loss.

---

Attentions help you:

- identify a hazard
- avoid the hazard
- recognize the consequences

**Important:** Identifies information that is especially important for successful application and understanding of the product.

# Summary of Changes

---

## BULLETIN 1305 PERFORMANCE ENHANCEMENTS

New features in Firmware Revision 6.01 include:

- **Increased Low Speed Torque.**

The parameter [**IR Comp %**] was added, allowing adjustment of the amount of IR compensation desired. This is used to compensate for stator resistance and allows much higher levels of starting torque. The default levels of [**Start Boost**] and operation of the [**Compensation**] parameter have changed. The default setting for [**Compensation**] is now “Comp” and functions from 1.1 to 120 Hertz.

- **Improved Acceleration.**

The acceleration current ramp regulator has been retuned and the current feedback filter time constant was reduced, allowing improved performance with short acceleration times under all load conditions. The drive power-up diagnostics were also shortened considerably, which improves response time to a START signal. The parameter [**Adaptive I Lim**] was also added for very quick accelerations with low system inertias.

- **Robust Current Limit.**

A fast frequency foldback was added to operate with the lower hardware current limit. This allows the drive to continue operating under adverse conditions.

- **Improved Speed Regulation.**

The parameter [**Rated Slip**] was added, which compensates for inherent slip in an induction motor. This assists in maintaining an induction motor shaft frequency under heavy loading conditions. The actual frequency value added may be viewed in [**Slip Comp Adder**].

- **Reduced Voltage Ring-up.**

Voltage Ring-up Reduction Software is enabled when [**Cable Length**] = “Long”. This software attempts to limit voltage ring-up.

- **Improved Drive Functionality.**

The [**Analog Filter**] parameter was added. This allows selection of the amount of software filtering applied to the 0-10 Volt and Potentiometer inputs in 25% increments. The lower the percentage, the less filtering applied.

The Stop Mode “DC Brake” has been greatly improved by incorporating a current limit function into this stopping mode.

The parameter [**DC Hold Time**] is now settable up to 150 seconds in 0.1 second increments and [**Maximum Voltage**] is now settable to 110% of the drive rating. Several additional parameters now have new factory default values.

### **SUMMARY OF DRIVE ENHANCEMENTS**

Refer to the following references in this manual:

Firmware Compatibility Chart	1-4
New Adaptive Current Limit Parameter	5-14
DC Hold Time Improvements	5-22
Compensation Improvements	5-24
New Preset Speed Defaults	5-27
New Analog Filter Parameter	5-31
Slip Compensation	5-35 & 5-36
IR Compensation	5-36
Updated Drive Specifications	A-2 through A-6
Updated Drive Accessories	C-1 & C-2





## Chapter 1 – Information and Precautions

Chapter Objectives . . . . .	1-1
Manual Objectives . . . . .	1-1
Receiving, Unpacking, Inspection, Storing . . . . .	1-2
General Precautions . . . . .	1-2
Conventions Used In This Manual . . . . .	1-3
Nameplate Location . . . . .	1-4
Firmware Compatibility . . . . .	1-4
Catalog Number Code Explanation . . . . .	1-5

## Chapter 2 – Installation/Wiring

Chapter Objectives . . . . .	2-1
Terminal Block Access . . . . .	2-3
Input Devices . . . . .	2-5
Input Power Conditioning . . . . .	2-6
Input Fusing . . . . .	2-6
Electrical Interference – EMI/RFI . . . . .	2-7
RFI Filtering . . . . .	2-8
CE Conformity . . . . .	2-8
Grounding . . . . .	2-9
Power Wiring . . . . .	2-11
Drive Operation without a Human Interface Module (HIM) . . . . .	2-17
Control Wiring . . . . .	2-17
Output Devices . . . . .	2-22
Cable Termination . . . . .	2-22
Adapters . . . . .	2-23

## Chapter 3 – Human Interface Module

Chapter Objectives . . . . .	3-1
HIM Description . . . . .	3-1
HIM Operation . . . . .	3-1
HIM Removal and Installation . . . . .	3-4
HIM Modes . . . . .	3-5
Program and Display Modes . . . . .	3-7
Process Mode . . . . .	3-10
EEPROM Mode . . . . .	3-11
Search Mode . . . . .	3-14
Control Status Mode . . . . .	3-15
Password Mode . . . . .	3-17

## Chapter 4 – Start-Up

Chapter Objectives . . . . .	4-1
Start-up Procedure . . . . .	4-1

## Chapter 5 – Programming

Chapter Objectives . . . . .	5-1
Chapter Conventions . . . . .	5-1
Function Index . . . . .	5-1
Parameter Flow Chart . . . . .	5-1
Programming Example . . . . .	5-4
Metering . . . . .	5-5
Set Up . . . . .	5-8
Advanced Setup . . . . .	5-15

Frequency Set . . . . .	5-25
Feature Select . . . . .	5-32
Output Configuration . . . . .	5-37
Faults . . . . .	5-39
Diagnostics . . . . .	5-42
Masks . . . . .	5-47
Owners . . . . .	5-50
Adapter I/O . . . . .	5-54
Process Display . . . . .	5-55
Linear List . . . . .	5-56

## **Chapter 6 – Troubleshooting and Fault Information**

Chapter Objectives . . . . .	6-1
Fault Information . . . . .	6-1

## **Appendix A – Block Diagram And Specifications**

## **Appendix B – Serial Communications**

## **Appendix C – Drive Accessories**

## **Appendix D – CE Conformity**

## CHAPTER OBJECTIVES

Chapter 1 provides information on the general intent of this manual, gives an overall description of the Bulletin 1305 Adjustable Frequency AC Drive (herein called “the drive”) and provides a listing of key drive options. Additionally, this chapter provides information on receiving and handling the drive.

## MANUAL OBJECTIVES

The purpose of this manual is to provide the user with the necessary information to install, program, start up and maintain the Bulletin 1305 drive. To assure successful installation and operation, the material presented must be thoroughly read and understood before proceeding. Particular attention must be directed to the **ATTENTION** and **Important** statements contained within.

**Chapter 2** provides instructions on how to mount and wire the drive. It also describes how to operate the drive without a Human Interface Module. Read the Motor Cable Length section on pages 2-13 – 2-16, and the contact closure inputs information in the Control Terminal Block descriptions on pages 2-19 – 2-21.

**Chapter 3** defines the display and control panel keys on the optional Human Interface Module. A flowchart is provided to guide the user through the key strokes of the various menu levels.

**Chapter 4** describes the steps to start up the drive. It includes a typical start up routine defining the adjustments and checks to assure proper operation.

**Chapter 5** outlines the parameter information of the drive such as description, number, type, units, factory default, minimum and maximum settings.

**Chapter 6** defines the various drive faults and the appropriate action to take as well as general troubleshooting information.

**Appendix A** contains a block diagram and general specifications of the drive.

**Appendix B** provides the necessary information for drive set up using a PLC<sup>®</sup>, SLC<sup>™</sup> or other logic controller. A table is provided that lists each parameter by parameter group with space for the user to record any custom parameter settings.

**Appendix C** lists the accessories and their catalog number.

**Appendix D** lists requirements for CE conformity.

**Index** – A comprehensive index is provided to assist the user in locating specific information. All parameters and fault information are listed alphabetically under parameters and faults respectively.

PLC is a registered trademark of Allen-Bradley Company.  
SLC is a trademark of Allen-Bradley Company.

**Receiving** – It is the responsibility of the user to thoroughly inspect the equipment before accepting the shipment from the freight company. Check the item(s) received against the purchase order. If any items are obviously damaged, it is the responsibility of the user not to accept delivery until the freight agent has noted the damage on the freight bill. Should any concealed damage be found during unpacking, it is again the responsibility of the user to notify the freight agent. The shipping container must be left intact and the freight agent should be requested to make a visual inspection of the equipment.

**Unpacking** – Remove all packing material from within and around the drive.

**Important:** Before the installation and start-up of the drive, a general inspection of the mechanical integrity (i.e. loose parts, wires, connections, etc.) should be made.

**Inspection** – After unpacking, check the item(s) nameplate catalog number against the purchase order. An explanation of the catalog numbering system for the Bulletin 1305 drive is included as an aid for nameplate interpretation. Refer to the following pages for complete nomenclature.

**Storing** – The drive should remain in its shipping container prior to installation. If the equipment is not to be used for a period of time, it must be stored according to the following instructions in order to maintain warranty coverage:

- Store in a clean, dry location.
- Store within an ambient temperature range of  $-40^{\circ}$  to  $+70^{\circ}$  C.
- Store within a relative humidity range of 0% to 95%, noncondensing.
- Do not store equipment where it could be exposed to a corrosive atmosphere.
- Do not store equipment in a construction area.

## GENERAL PRECAUTIONS

In addition to the precautions listed throughout this manual, the following statements which are general to the system must be read and understood.

The DC Bus Charge Indicator is a neon bulb that will be illuminated when power is applied to the drive.



**ATTENTION:** This drive contains ESD (Electrostatic Discharge) sensitive parts and assemblies. Static control precautions are required when installing, testing, or servicing this assembly. Component damage may result if ESD control procedures are not followed. If you are not familiar with static control procedures, reference A-B publication 8000-4.5.2, “*Guarding Against Electrostatic Damage*” or any other applicable ESD protection handbook.



**ATTENTION:** An incorrectly applied or installed drive can result in component damage or a reduction in product life. Wiring or application errors, such as, undersizing the motor, incorrect or inadequate AC supply, or excessive ambient temperatures may result in malfunction of the system.



**ATTENTION:** Only personnel familiar with the the drive and associated machinery should plan or implement the installation, start-up and subsequent maintenance of the system. Failure to comply may result in personal injury and/or equipment damage.

## CONVENTIONS USED IN THIS MANUAL

**Programmer Terminal** will appear as Human Interface Module or HIM.

To help differentiate parameter names, display text, and control keys from other text in this manual, the following conventions will be used:

**Parameter Names** will appear in **[brackets]**

**Display Text** will appear in “quotes”.

**Control Key Names** will appear as depicted on the control key, if the key is labeled with letters or numbers (i.e., JOG, SEL) or if the key depicts an icon, its operative term appear with initial capitalization (i.e., Stop, Increment, Enter).

## NAMEPLATE LOCATION

Figure 1.1 Bulletin 1305 Nameplate Location

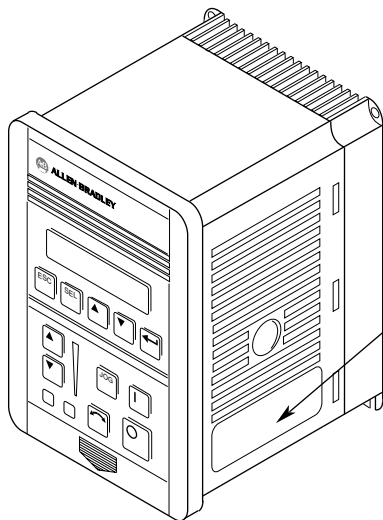

Nameplate  
Located  
on Exterior  
of Enclosure

Figure 1.2 Nameplate Information

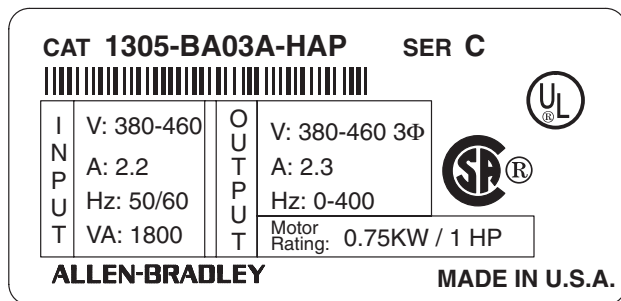

AB0516C

## FIRMWARE COMPATIBILITY <sup>①</sup>

---

Drive: Series C, FRN 6.01 and up

---

HIM: Series A, FRN 1.0 through 3.0  
Series B, FRN 1.0

---

<sup>①</sup> Specific Firmware versions are identified by digits to the right/left of decimal.  
Example 1.01, 2.01.

Firmware version can be found on the drive carton label, on integrated circuits found on the Control Board (see Figure 2.3), or can be viewed in Drive Diagnostics (see Chapter 5).



Table 1.A Drive Rating and Derating Guidelines

Voltage Rating	Catalog Number IP30 (NEMA Type 1)	Motor Rating					
		Three-Phase Input			Single-Phase Input		
		HP	kW	Output Current <sup>①②</sup> (A)	HP	kW	Output Current <sup>①②</sup> (A)
200-230V 50/60 Hz	1305-AA02A	0.5	0.37	2.3	0.25	0.19	1.2
	1305-AA03A	0.75	0.55	3	0.5	0.37	2.3
	1305-AA04A	1	0.75	4.5	0.75	0.55	3
	1305-AA08A	2	1.5	8	1	0.75	4.5
	1305-AA12A	3	2.2	12 <sup>③</sup>	2	1.5	8 <sup>③</sup>
380-460V 50/60 Hz	1305-BA01A	0.5	0.37	1.3	Not Available		
	1305-BA02A	0.75	0.55	1.6			
	1305-BA03A	1	0.75	2.3			
	1305-BA04A	2	1.5	4			
	1305-BA06A	3	2.2	6 <sup>④</sup>			
	1305-BA09A	5	4.0	9 <sup>⑤</sup>			

In general:

- ① Motor Full Load Amps (FLA) should not exceed the drive output current rating.
- ② If the [PWM Frequency] is set above 4kHz, the output current must be derated per the chart on page 5-20.

When operating the drive in an ambient temperature at or near the maximum operating temperature (50°C), the following derating guidelines are recommended to guard against overheating depending on application and operating conditions.

- ③ Output current value listed for 200V input voltage. At 230V input voltage, output current is 9.6A for 3 phase and 6.8A for single phase.
- ④ Output current value listed for 380V input voltage. At 415V input voltage, output current is 5.3A. At 460V input voltage, output current is 4.8A.
- ⑤ Output current value listed for 380V input voltage. At 415V input voltage, output current is 8.4A. At 460V input voltage, output current is 7.6A.

For derating guidelines at ambient temperatures between 40°C and 50°C, consult Allen-Bradley.

### CHAPTER OBJECTIVES

Chapter 2 provides the information needed to properly mount and wire the drive. Since most start-up difficulties are the result of incorrect wiring, every precaution must be taken to assure that the wiring is done as instructed. All items must be read and understood before the actual installation begins.



**ATTENTION:** The following information is merely a guide for proper installation. The National Electrical Code and any other governing regional or local code will overrule this information. The Allen-Bradley Company cannot assume responsibility for the compliance or the noncompliance to any code, national, local or otherwise for the proper installation of this drive or associated equipment. A hazard of personal injury and/or equipment damage exists if codes are ignored during installation.

Figure 2.1 Mounting Requirements

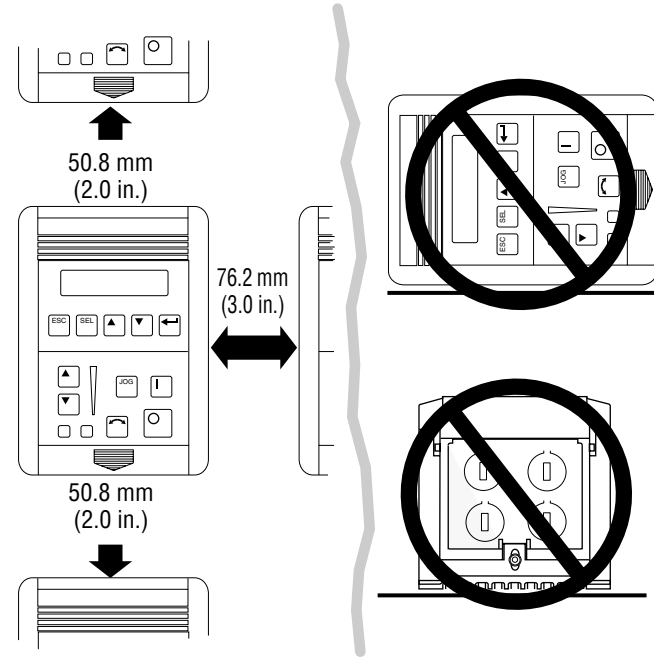

**Important:** The drive must be mounted to a metallic surface.

**Figure 2.2 Bulletin 1305 Approximate Dimensions**

Dimensions shown are in millimeters (inches). Shipping weights are in kilograms (pounds).

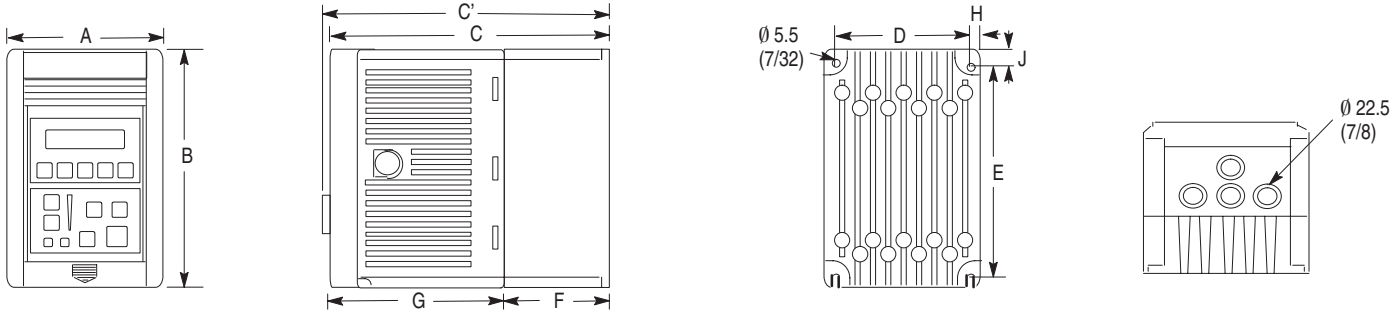

200/230 V Cat. No. 1305-...	380/460 V Cat. No. 1305-...	A Width	B Height	C Depth w/o Pot.	C' Depth w/ Pot.	D	E	F	G	H	J	Approx. Shipping Weight
AA02A AA03A		120 (4-23/32)	195 (7-11/16)	122 (4-13/16)	127.1 (5)	110 (4-11/32)	180 (7-1/16)	9 (11/32)	113 (4-7/16)	5 (7/32)	7.5 (5/16)	1.6 (3.5)
AA04A		120 (4-23/32)	195 (7-11/16)	140 (5-1/2)	145.1 (5-23/32)	110 (4-11/32)	180 (7-1/16)	27 (1-1/16)	113 (4-7/16)	5 (7/32)	7.5 (5/16)	1.9 (4.2)
AA08A	BA01A BA02A BA03A BA04A BA06A	170 (6-11/16)	195 (7-11/16)	179 (7-1/16)	184.1 (7-1/4)	160 (6-5/16)	180 (7-1/16)	66 (2-19/32)	113 (4-7/16)	5 (7/32)	7.5 (5/16)	3.6 (8.0)
AA12A	BA09A	210 (8-1/4)	195 (7-11/16)	179 (7-1/16)	184.1 (7-1/4)	200 (7-7/8)	180 (7-1/16)	66 (2-19/32)	113 (4-7/16)	5 (7/32)	7.5 (5/16)	4.2 (9.2)

## TERMINAL BLOCK ACCESS

To access the power and control terminal blocks, perform the following procedure:

1. Remove power from the drive.
2. Lower the hinged panel located below the HIM or blank front panel.
3. For drives equipped with a blank front panel, slide the panel downward and remove it from the drive. Skip to Step 5.
4. For drives equipped with a HIM, press the retaining lever directly beneath the HIM and slide the HIM downward to remove it from drive.
5. Remove the drive front cover by grasping the upper corners of the cover and pulling at a 90-degree angle to the drive. Lift the cover off.

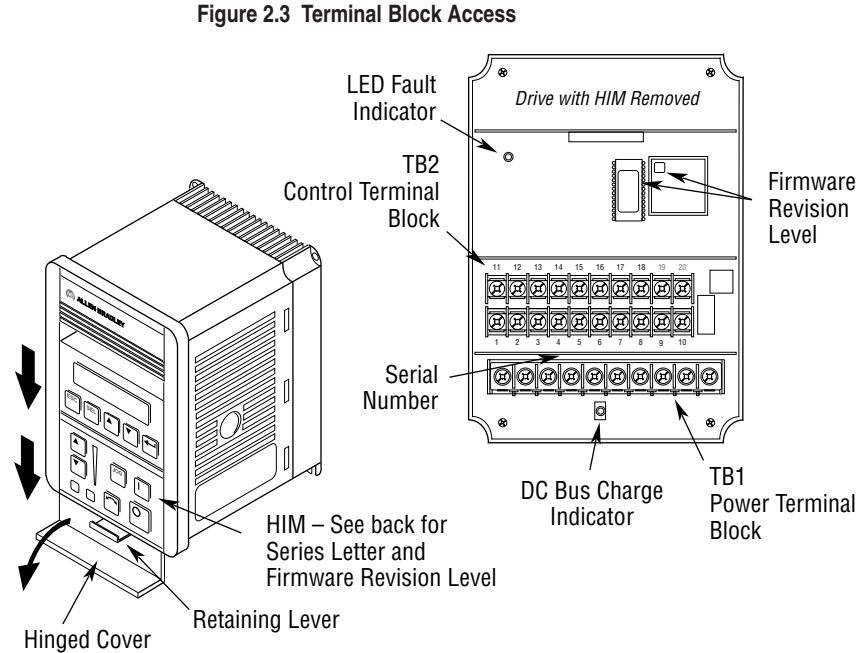

**ATTENTION:** Proceed with caution. A DC Bus Voltage may be present at the Power Terminal Block (TB1) even when power is removed from the drive.

Figure 2.4 Installation Guidelines

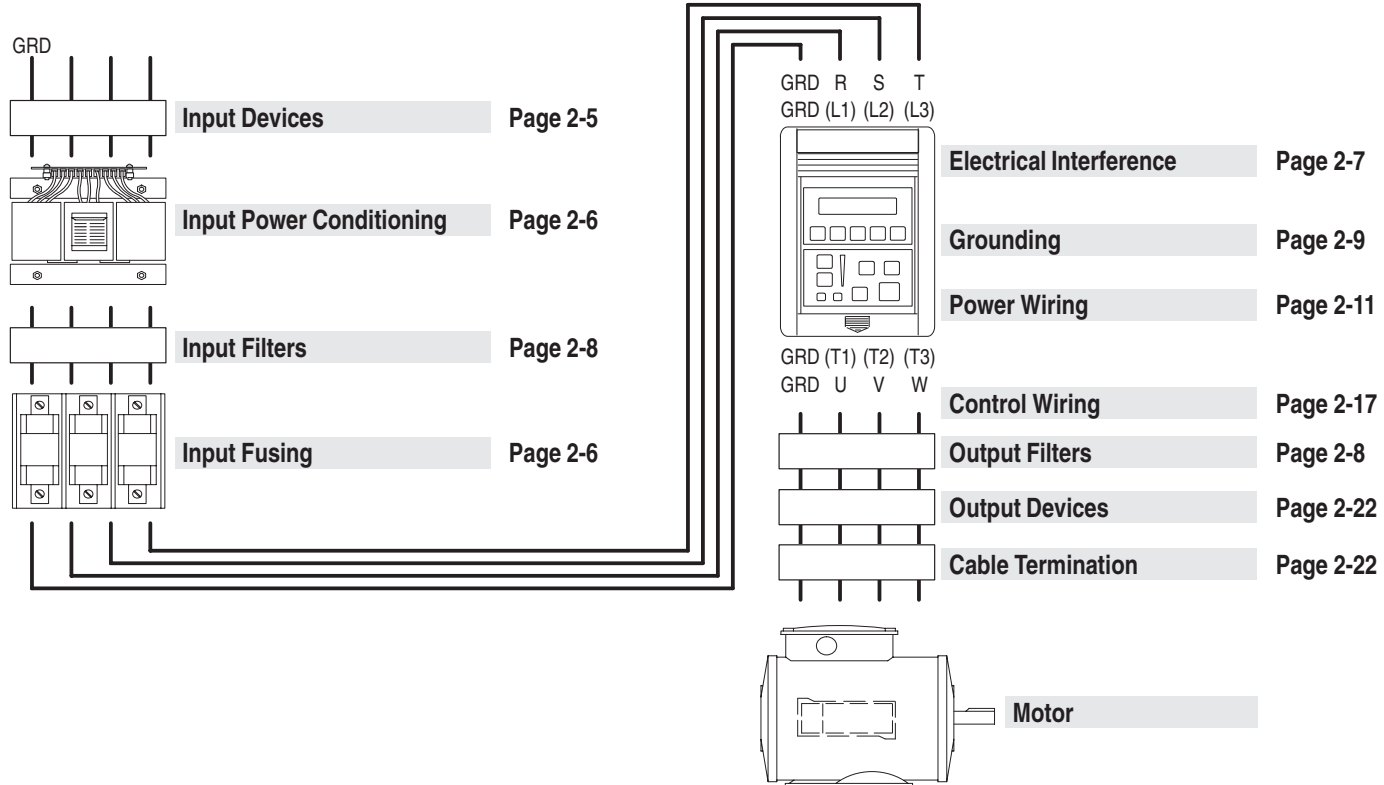

---

## INPUT DEVICES

### Starting and Stopping the Motor

---



**ATTENTION:** The drive start/stop control circuitry includes solid-state components. If hazards due to accidental contact with moving machinery or unintentional flow of liquid, gas or solids exist, an additional hardwired stop circuit is required to remove AC line power to the drive. When AC input power is removed, there will be a loss of inherent regenerative braking effect and the motor will coast to a stop. An auxiliary braking method may be required.

---

### Repeated Application/Removal of Input Power

---



**ATTENTION:** The drive is intended to be controlled by control input signals that will start and stop the motor. A device that routinely disconnects then reapplies line power to the drive (input contactor, etc.) for the purpose of starting and stopping the motor should not be used. If it is necessary to use this method for starting and stopping or if frequent cycling of power is unavoidable, make sure that it does not occur more than once a minute.

---

### Input Contactor

---



**ATTENTION:** An incorrectly applied or installed system can result in component damage or reduction in product life. Follow these recommendations for application of an input contactor to a 1305 drive.

---

**Normal Operation:** After the input contactor is closed, the enable, start, and stop signals may be applied. These control signals must be removed before opening the input contactor. The input contactor must not be opened and closed more than once a minute.

### Bypass Contactors

---



**ATTENTION:** An incorrectly applied or installed system can result in component damage or reduction in product life. The most common causes are:

- Wiring AC line to drive output or control terminals.
- Improper voltage placed on control terminals.
- Improper bypass or output circuits not approved by Allen-Bradley.
- Output circuits which do not connect directly to the motor.
- Incorrect or inadequate AC supply.
- Excessive ambient temperature.

Contact Allen-Bradley for assistance with application or wiring.

---

## INPUT POWER CONDITIONING

The drive is suitable for direct connection to a correct voltage, single phase or three-phase, AC power line. However, there are certain power line conditions which may introduce the possibility of drive input power component malfunction. To reduce the possibility of these malfunctions, a line reactor or isolation type transformer with an input impedance of 3% of the drive input VA rating may be required.

The basic rules for determining if a line reactor or isolation type transformer is required are as follows:

1. If the AC line supplying the drive has power factor correction capacitors that are switched in and out, installing an AC line reactor or isolation type transformer between the capacitor bank and the drive input may be required. Damage to drives can occur from the extreme current spikes caused by capacitor switching.
2. If the AC line frequently experiences transient power interruptions or significant voltage spikes, an AC line reactor or isolation type transformer may be required. Damage to drives can occur from extreme current spikes.

## INPUT FUSING



**ATTENTION:** The drive does not provide branch circuit protection. Specifications for the recommended fuse size and type which provide branch circuit protection against short circuits are provided in Table 2.A. Branch circuit breakers or disconnect switches cannot provide this level of protection for drive components.

**Table 2.A Maximum Recommended AC Input Line Fuse  
UL Class J, T, CC, or BS88 (or equivalent)**

Three-Phase Rating – kW (HP)	Single-Phase Rating – kW (HP)	Fuse 200-230V Rating	Fuse 380-460V Rating
0.37 (0.25)	0.19 (0.25)	6A	3A ①
0.55 (0.75)	0.37 (0.5)	6A	3A ①
0.75 (1)	0.55 (0.75)	10A	6A ②
1.5 (2)	0.75 (1)	15A	10A ②
2.2 (3)	1.5 (2)	25A	15A ②
4.0 (5)	—	—	20A ②

① *Must be dual element time delay, Bussmann LPJ or equivalent.*

② *If fuse blowing is a problem, use dual element type fuses.*

## **ELECTRICAL INTERFERENCE – EMI/RFI**

### **Immunity**

The 1305 drive is designed for immunity to most externally generated interference. Usually, no special precautions are required beyond the installation practices provided in this publication.

It is recommended that the coils of DC energized contactors associated with drives be suppressed with a diode or similar device, since they can generate severe electrical transients.

In areas subject to frequent lightening strikes, additional surge suppression is advisable.

### **Emission**

Careful attention must be given to the arrangement of power and ground connections to the drive to avoid interference with nearby sensitive equipment. The cable to the motor carries switched voltages and should be routed well away from sensitive equipment.

The ground conductor of the motor cable should be connected to the drive ground (GRD) terminal directly. Connecting this ground conductor to a cabinet ground point or ground bus bar may cause high frequency current to circulate in the ground system of the enclosure. The motor end of this ground conductor must be solidly connected to the motor case ground.

Shielded or armored cable may be used to guard against radiated emissions from the motor cable. The shield or armor should be connected to the drive ground terminal and the motor ground as outlined in the Grounding section of this Installation chapter.

Common mode chokes are recommended at the drive output to reduce the common mode noise.

An RFI filter can be used and in most situations provides an effective reduction of RFI emissions that may be conducted into the main supply lines.

If the installation combines a drive with sensitive devices or circuits, it is recommended that the lowest possible drive PWM frequency be programmed.

## RFI FILTERING

1305 drives can be installed with an RFI filter, which controls radio–frequency conducted emissions into the main supply lines and ground wiring.

If the cabling and installation recommendation precautions described in this manual are adhered to, it is unlikely that interference problems will occur when the drive is used with conventional industrial electronic circuits and systems.

However, a filter is recommended if there is a likelihood of sensitive devices or circuits being installed on the same AC supply or if the motor cable exceeds 75 meters (250 feet). Beyond this length, capacitance to ground will increase the supply emissions.

Where it is essential that very low emission levels must be achieved or if conformity with standards is required the optional RFI filter should be used. Refer to Appendix D and instructions included with the filter for installation and grounding information.

## RFI Filter Leakage Current

The optional RFI filter may cause ground leakage currents. Therefore a solid ground connection must be provided.

---



**ATTENTION:** To guard against possible equipment damage, RFI filters can only be used with AC supplies that are nominally balanced with respect to ground. In some installations, three–phase supplies are occasionally connected in a 3-wire configuration with one phase grounded (Grounded Delta). The filter must not be used in Grounded Delta supplies.

---

## CE Conformity

Refer to Appendix D.

## GROUNDING

Refer to the grounding diagram on the following page. The drive must be connected to system ground at the power ground (GRD) terminal provided on the power terminal block (TB1). Ground impedance must conform to the requirements of national and local industrial safety regulations (NEC, VDE 0160, BSI, etc.) and should be inspected and tested at appropriate and regular intervals. In any cabinet, a single, low-impedance ground point or ground bus bar should be used. All circuits should be grounded independently and directly. The AC supply ground conductor should also be connected directly to this ground point or bus bar.

### Sensitive Currents

It is essential to define the paths through which the high frequency ground currents flow. This will assure that sensitive circuits do not share a path with such current, and to minimize the area enclosed by these paths. Current carrying ground conductors must be separated. Control and signal ground conductors should not run near or parallel to a power ground conductor.

### Motor Cable

The ground conductor of the motor cable (drive end) must be connected directly to the ground terminal, not to the enclosure bus bar. Grounding directly to the drive (and filter, if installed) provides a direct route for high frequency current returning from the motor frame and ground conductor. At the motor end,

the ground conductor should also be connected to the motor case ground. If shielded or armored cables are used, the same grounding methods should be used for the shield/armor as well.

### Discrete Control and Signal Wiring

DO NOT connect drive Common terminals (TB2) to ground. DO NOT switch these inputs using non-isolated TTL type circuits. Use dry relay contacts to switch signal inputs to Common. Only isolated 4-20mA sources are recommended. There must be no ground potential difference between source and drive.

### Safety Ground

This is the safety ground required by code. The ground bus can be connected to adjacent building steel (girder, joist) or a floor ground loop, provided grounding points comply with NEC regulations.

### RFI Filter

**Important:** Using an optional RFI filter may result in relatively high ground leakage currents. The filter must be permanently installed and solidly grounded. Grounding must not rely on flexible cables and should not include any form of plug or socket that would permit inadvertent disconnection. The integrity of this connection should be periodically checked.

Figure 2.5 Recommended 1305 Grounding for Installation Without EMI Filter (Non-CE)

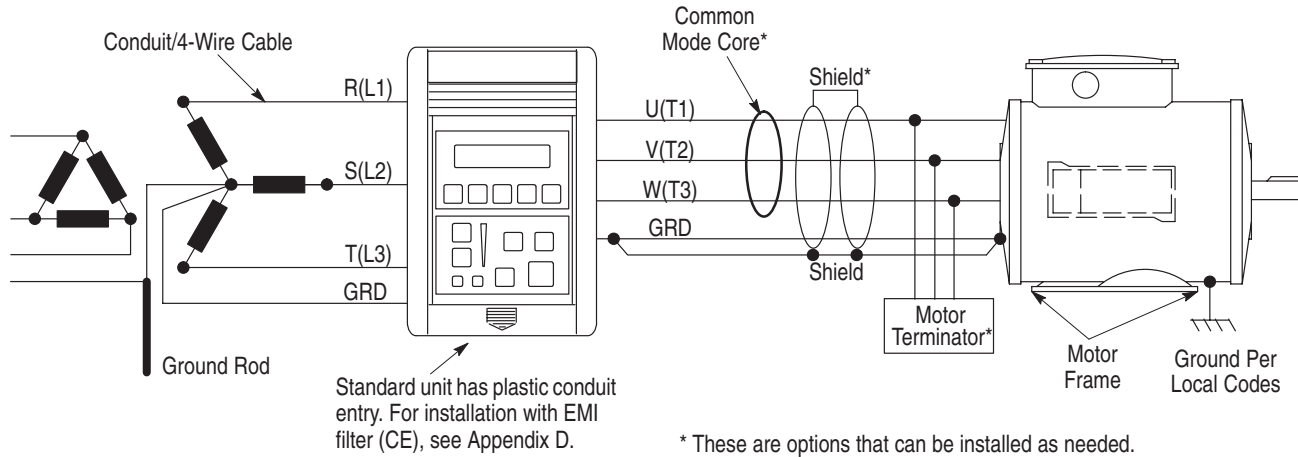

## POWER WIRING

Input and output power connections are performed through a ten position terminal block, TB1 (see page 2-3 for location).

**Figure 2.6 Power Terminal Block Designations (TB1)**

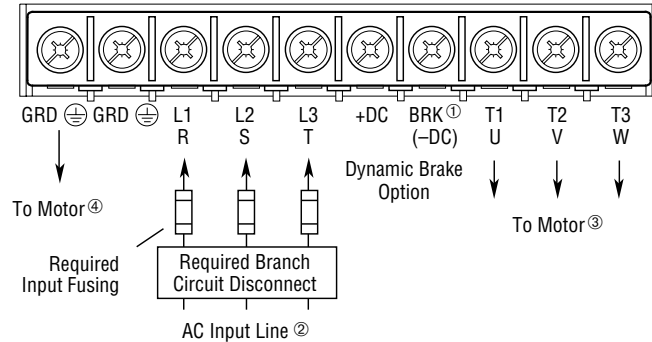

- ① Connection for Dynamic Brake Resistors for all models except the 200-230 Volt, 0.37 to 0.75 kW (0.5 to 1 HP) drive. **Important:** The **[DB Enable]** parameter must be enabled for proper operation.
- ② For single phase applications, the AC input line can be connected to any two of the three input terminals R, S, T (L1, L2, L3).
- ③ 1305 drives are UL and cUL listed, and CSA certified as a motor overload protective device. An external overload relay is **not required** for single motor applications. **Important:** This drive is not intended for use with single phase motors.
- ④ Ground from drive to motor frame must be an independent continuous insulated wire run.

**Table 2.B Power Block Terminal (TB1)**

Terminals	Description
GRD	Earth Ground
R, S, T (L1, L2, L3)	AC Input Line Terminals
+DC, BRK (or -DC)	Dynamic Brake Option - Refer to instructions included with option
U, V, W (T1, T2, T3)	Motor Connection

**Table 2.C Screw Size, Wire Size and Torque Specifications**

Terminal	Screw Size	Max./Min. Wire Size mm <sup>2</sup> (AWG)	Maximum Torque N-m (lb-ins.)
TB1 (0.37-0.75 kW/0.5-1 HP)	M4	3.5/0.75 (12/18)	0.90 (8)
TB1 (All except above)	M4	4/0.75 (10/18)	1.81 (16)
TB2 (All)	M3.5	1.5/0.20 (14/24)	0.90 (8)

### **Motor Cables**

A variety of cable types are acceptable for drive installations. For many installations, unshielded cable is adequate, provided it can be separated from sensitive circuits. As an approximate guide, allow a spacing of 1 meter (3.3 feet) for every 10 meters (33 feet) of length. In all cases, long parallel runs must be avoided.

The cable should be 4-conductor with the ground lead being connected directly to the drive ground terminal (GRD) and the motor frame ground terminal.

### **Shielded Cable**

Shielded cable is recommended if sensitive circuits or devices are connected or mounted to the machinery driven by the motor. The shield must be connected to the drive ground and motor frame ground. The connection must be made at both ends to minimize the external magnetic field.

If cable trays or large conduits are to be used to distribute the motor leads for multiple drives, shielded cable is recommended to reduce or capture the noise from the motor leads and minimize “cross coupling” of noise between leads of different drives. The shield should be connected to the ground connections at both the motor and drive end.

Armored cable also provides effective shielding. Ideally, it should be grounded only at the drive (GRD) and motor frame. Some armored cable has a PVC coating over the armor to prevent incidental contact with grounded structure. If, due to the type of connector, the armor must be grounded at the cabinet entrance, shielded cable should be used within the cabinet to continue as far as possible to the coaxial arrangement of power cable and ground.

In some hazardous environments it is not permissible to ground both ends of the cable armor. This is because of the possibility of high current circulating at the input frequency if the ground loop is cut by a strong magnetic field. This only applies in the proximity of powerful electrical machines. In such case, the ground connection at one end may be made through a capacitance, which will block the frequency current but present a low impedance to RF. Because of the highly pulsed nature of the circulating current, the capacitor type used must be rated for AC-to-ground voltage. Consult factory for specific guidelines.

## Conduit

If metal conduit is preferred for cable distribution, the following guidelines must be followed.

1. Drives are normally mounted in cabinets and ground connections are made at a common ground point in the cabinet. If the conduit is connected to the motor junction box and at the drive end, no further conduit connections are necessary.
2. No more than three sets of motor leads can be routed through a single conduit. This will minimize “cross talk” that could reduce the effectiveness of the noise reduction methods described. If more than three drive/motor connections per conduit are required, shielded cable as described above must be used. If practical, each conduit should contain only one set of motor leads.



**ATTENTION:** To avoid a possible shock hazard caused by induced voltages, unused wires in the conduit must be grounded at both ends. For the same reason, if a drive sharing a conduit is being serviced or installed, all drives using this conduit should be disabled. This will eliminate the possible shock hazard from “cross coupled” drive motor leads.

## Motor Lead Lengths

Installations with long cable lengths between the 1305 drive and motor may require the use of an output reactor or Terminator. The following guidelines allow for selection of the appropriate drive HP rating (and output reactor or Terminator, if required) to work with an existing motor, and provide motor-lead length solutions for new installations.

Voltage doubling at motor terminals, known as reflected wave phenomenon, standing wave or transmission line effect, can occur when using long motor cables with drives. Long motor cables can cause capacitive charging current in excess of the rating of a smaller drive. To ensure proper installation, follow the guidelines provided.

All cabling and distances are based on using 14 AWG, 4-conductor type cabling.

In general, motors designed and built without phase separating insulation paper between motor windings should be classified as 1000VP-P insulation design.

### Section A: No Output Reactor or Terminator

Table 2.D lists the maximum cable lengths permitted when applying a 460V, 1305 drive to a 460V motor for motor insulation ratings of 1000V, 1200V, and 1600V without an output reactor or Terminator. Shielded and unshielded maximum cable lengths also are listed. Tables are based on operation at nominal line condition (480V).

**1000V and 1200V Motor Insulation Ratings:** Cable lengths listed in Table 2.D are for operating the 1305 drive at a maximum carrier frequency of 4 kHz on motor insulation ratings of 1000V and 1200V. Consult the factory regarding operation above 4 kHz carrier frequency. Multiply listed distances by 0.85 for operation at high line conditions (above 480V). If the maximum cable length used exceeds the distances indicated, refer to Section B.

**1600V Motor Insulation Ratings:** Cable lengths listed in Table 2.D are based on operating the 1305 drive at a maximum carrier frequency of 2 kHz on motor insulation ratings of 1600V. Consult the factory regarding operation above 2 kHz carrier frequency. Multiply listed distances by 0.55 for operation at high line conditions (above 480V). If the maximum cable length used exceeds the distances indicated, refer to Section B.

The Allen-Bradley 1329-HR is representative of 1600V<sub>P-P</sub> insulation rating designs and is recommended in applications where long cable lengths are required.

**Table 2.D Maximum Motor Cable Length Restrictions**

Drive HP (460V)	Motor HP (460V)	No External Devices or Reactor at the Motor			
		Using a Motor with Insulation V <sub>P-P</sub>			
		1000 Volt Any Cable	1200 Volt Any Cable	1600 Volt 1329 HR Shielded Cable	1600 Volt 1329 HR Unshielded Cable
<b>Maximum Carrier Frequency</b>		4 kHz	4 kHz	2 kHz	2 kHz
<b>High-Line Derate Multiplier</b>		0.85	0.85	0.55	0.55
5	5	9m (30ft)	30m (100ft)	121m (400ft)	121m (400ft)
	3	9m (30ft)	30m (100ft)	121m (400ft)	121m (400ft)
	2	9m (30ft)	30m (100ft)	121m (400ft)	121m (400ft)
3	3	9m (30ft)	30m (100ft)	91m (300ft)	121m (400ft)
	2	9m (30ft)	30m (100ft)	121m (400ft)	121m (400ft)
	1	9m (30ft)	30m (100ft)	121m (400ft)	121m (400ft)
2	2	9m (30ft)	30m (100ft)	76m (250ft)	121m (400ft)
	1	9m (30ft)	30m (100ft)	121m (400ft)	121m (400ft)
	0.5	9m (30ft)	30m (100ft)	121m (400ft)	121m (400ft)
1	1	9m (30ft)	30m (100ft)	68m (225ft)	121m (400ft)
	0.5	9m (30ft)	30m (100ft)	121m (400ft)	121m (400ft)
0.5	0.5	9m (30ft)	30m (100ft)	45m (150ft)	106m (350ft)

## Section B: Use of Output Reactor or Terminator

For longer motor-lead length applications, an output reactor or Terminator is required to ensure proper drive operation, and for the motor to operate within its specified insulation rating. The guidelines in Table 2.E are required for proper drive and motor operation, or motor designs without phase-separating insulation paper between motor windings.

Applications with non-inverter duty rated motors, with long lead lengths, require an output reactor or Terminator. An output reactor or Terminator helps reduce voltage reflection to the motor to levels which are less than the motor insulation rating.

Table 2.E lists maximum cable lengths that can be run when using an output reactor, or one of two available Terminators, for motor insulation ratings of 1000V, 1200V, and 1600V. Shielded and unshielded maximum cable lengths also are listed.

When an output reactor is required, locate the reactor at the drive if possible. Consult the factory for applications which require mounting the reactor at the motor.

**1000V and 1200V Motor Insulation Ratings:** Cable lengths listed in Table 2.E are for operating the 1305 drive at a maximum carrier frequency of 2 kHz on motor insulation ratings of 1000V and 1200V when used with an output reactor or Terminator. Consult the factory regarding operation above 2 kHz carrier frequency. Multiply listed distances by 0.85 for operation at high line conditions (above 480V).

**1600V Motor Insulation Ratings:** Cable lengths listed in Table 2.E are based on operating the 1305 drive at a maximum carrier frequency of 2 kHz on motor insulation ratings of 1600V. Consult the factory regarding operation above 2 kHz carrier frequency.

The Allen-Bradley 1329-HR is representative of 1600V<sub>P-P</sub> insulation rating designs and is recommended in applications where long cable lengths are required.

**Example:** An existing installation includes a 2 HP, 1200V motor with a 84-meter (275-foot) cable-length requirement between the 1305 drive and the motor. What are the possible solutions to this installation?

1. Table 2.D indicates that either an output reactor or a Terminator is required for this installation example. Consult Table 2.E for output reactor, Terminator, and cable types.
2. Table 2.E suggests these possible solutions:
  - Install a 1305 2-HP drive with an output reactor installed at the drive, and use unshielded cable.
  - Install a 1305 3-HP drive with an output reactor installed at the drive, and use shielded or unshielded cable.
  - Install a 1305 2-HP drive with a 1204-TFA1 Terminator, and use shielded or unshielded cable.

Contact Allen-Bradley for further assistance if required.

Table 2.E Maximum Motor Cable Length

Drive HP (460V)	Motor HP (460V)	Reactor <sup>①</sup> at the Drive			With 1204-TFB2 Terminator		With 1204-TFA1 Terminator			
		Using a Motor with Insulation $V_{P-P}$			Using a Motor with Insulation $V_{P-P}$		Using a Motor with Insulation $V_{P-P}$			
		1000 Volt	1200 Volt or 1600 Volt		1000 Volt or 1200 Volt		1000 Volt		1200 Volt	
		Any Cable	Shielded	Unshielded	Shielded	Unshielded	Shielded	Unshielded	Shielded	Unshielded
Maximum Carrier Frequency		2 kHz	2 kHz	2 kHz	2 kHz	2 kHz	2 kHz	2 kHz	2 kHz	2 kHz
High-Line Derating Multiplier		0.85	0.85	0.85	0.85	0.85	0.85	0.85	0.85	0.85
5	5	15m (50ft)	182m (600ft)	182m (600ft)	NR	NR	91m (300ft)	61m (200ft)	91m (300ft)	121m (400ft)
	3	15m (50ft)	182m (600ft)	182m (600ft)	91m (300ft)	121m (400ft)	99m (325ft)	61m (200ft)	152m (500ft)	121m (400ft)
	2	15m (50ft)	182m (600ft)	182m (600ft)	121m (400ft)	182m (600ft)	99m (325ft)	61m (200ft)	182m (600ft)	121m (400ft)
3	3	15m (50ft)	91m (300ft)	182m (600ft)	NR	NR	91m (300ft)	61m (200ft)	91m (300ft)	121m (400ft)
	2	15m (50ft)	182m (600ft)	182m (600ft)	91m (300ft)	121m (400ft)	99m (325ft)	61m (200ft)	152m (500ft)	121m (400ft)
	1	15m (50ft)	182m (600ft)	182m (600ft)	91m (300ft)	182m (600ft)	99m (325ft)	61m (200ft)	182m (600ft)	121m (400ft)
2	2	15m (50ft)	76m (250ft)	167m (550ft)	NR	NR	91m (300ft)	61m (200ft)	91m (300ft)	121m (400ft)
	1	15m (50ft)	182m (600ft)	182m (600ft)	61m (200ft)	61m (200ft)	99m (325ft)	61m (200ft)	121m (400ft)	121m (400ft)
	0.5	15m (50ft)	182m (600ft)	182m (600ft)	91m (300ft)	121m (400ft)	99m (325ft)	61m (200ft)	152m (500ft)	121m (400ft)
1	1	15m (50ft)	68m (225ft)	152m (500ft)	NR	NR	45m (150ft)	61m (200ft)	45m (150ft)	76m (250ft)
	0.5	15m (50ft)	121m (400ft)	182m (600ft)	NR	NR	76m (250ft)	61m (200ft)	76m (250ft)	121m (400ft)
0.5	0.5	15m (50ft)	45m (150ft)	106m (350ft)	NR	NR	NR	NR	NR	NR

NR = Not Recommended.

- ① **Important:** A 3% reactor reduces motor stress but may cause a degradation of motor waveform quality. Reactors must have a turn-to-turn insulating rating of 2100 volts or higher. Reactors are not recommended for lightly loaded applications because overvoltage trips may result at low output frequencies.

## DRIVE OPERATION WITHOUT A HUMAN INTERFACE MODULE (HIM)

Bulletin 1305 drives are functional without the use of the Human Interface Module (HIM). All control functions can be performed from the control terminal block (TB2). See Table 2.F for control descriptions. Programming must be performed using a HIM or PLC Remote I/O function. If operating without a HIM, you must use an external Frequency Source on TB2.

### Frequency Source

To control frequency from the control terminal block (TB2) an input is required to SW3 at TB2. The input to SW3 changes the frequency source from [Freq Select 1] to [Freq Select 2]. The factory default setting for [Freq Select 2] is the “Remote Pot”.

If a 0 – 10 Volt or 4 – 20mA frequency source is required, then the [Freq Select 1] or [Freq Select 2] parameters must be programmed to select that source. These parameters can be programmed using the optional Human Interface Module or through serial communications when using an optional Bulletin 1203 Communication Module. See Appendix C for catalog numbers of these accessories.

Refer to Chapter 5 for the factory default settings for all parameters. Special attention should be paid to Table 5.A on page 5-29 and Table 5.B on page 5-30. These tables demonstrate what frequency source and accel and decel parameters can be selected based on the inputs to SW1, SW2 and SW3 at TB2.

## CONTROL WIRING

**Important:** All common terminals are tied together within the drive and internally connected to chassis ground. Recommended practice is to run all signal wiring in separate steel conduit.



**ATTENTION:** Drive can be permanently damaged if any EXTERNAL control voltage is applied to terminals 5 – 8 and 11 – 18. DO NOT connect drive Common terminals (TB2) to ground. DO NOT switch these inputs using non-isolated TTL type circuits. Use dry relay contacts to switch signal inputs to Common. Only isolated 4-20mA sources are recommended. There must be no ground potential difference between source and drive.

The factory default control wire scheme is “3 Wire” control. The [Input Mode] parameter can be used to program the drive to operate using a two wire “Run Forward/Run Reverse” control wire scheme. Refer to Chapter 4, Step 10 for programming instructions. Figures 2.7 through 2.10 show the wiring diagrams for the different input modes.

**Important:** If the [Input Mode] is changed, power must be cycled to the drive for the change to take effect. The Start and Reverse functions operate differently for the two different modes.

### Three Wire Control

When using this control scheme, the factory default for the reverse function is controlled from TB2. To enable Reverse operation from the HIM or other serial communication adapters, Bit 0 of the **[Direction Mask]** parameter must be changed from “1” to a “0”. See page 5-47. See Chapter 5 for general programming instructions.

### Two Wire “Run Forward/Run Reverse” Control

To use a two wire “Run Forward/Run Reverse” control scheme, Bit 0 of the **[Direction Mask]** must be set to a “1.” For proper operation of the “Run Forward/Run Reverse” mode, install a jumper across terminals 7 and 8 (Stop) and terminals 11 and 12 (Enable).

### 3W/2nd Acc and Run F/R 2nd A Control

The HIM module is limited in the number of characters in the LCD display. Definitions of these functions are as follows. Refer to Chapter 5, Table 5.A for configuration of switches or inputs to TB2.

**3w/2nd Acc** = Three Wire, 2nd Acceleration

**Run F/R 2nd A** = Run Forward/Reverse, 2nd Acceleration

### MOP Function

The MOP function is a digital solid-state circuit that produces the same effect as rotating a speed reference potentiometer with a small DC motor. This permits local (HIM) or remote (TB2) control of the command frequency.

**Important:** The drive can still be started from any adapter (HIM or a serial device) and will run at the last commanded direction unless the start, jog and reverse functions of that adapter have been disabled (See **[Start Mask]**, **[Direction Mask]** and **[Jog Mask]**). See page 5-47 and 5-48.

**Important:** A stop command can be issued from any adapter at all times.

**Important:** If a Jog is initiated, the drive will Jog in the direction last traveled.

**Figure 2.7 TB2 Designations**

[Input Mode] = "Three Wire" or [Input Mode]="3 w/2nd Acc."

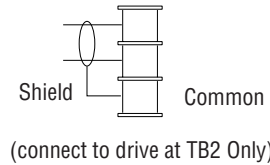
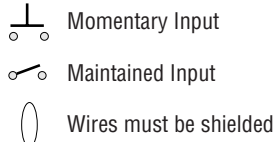
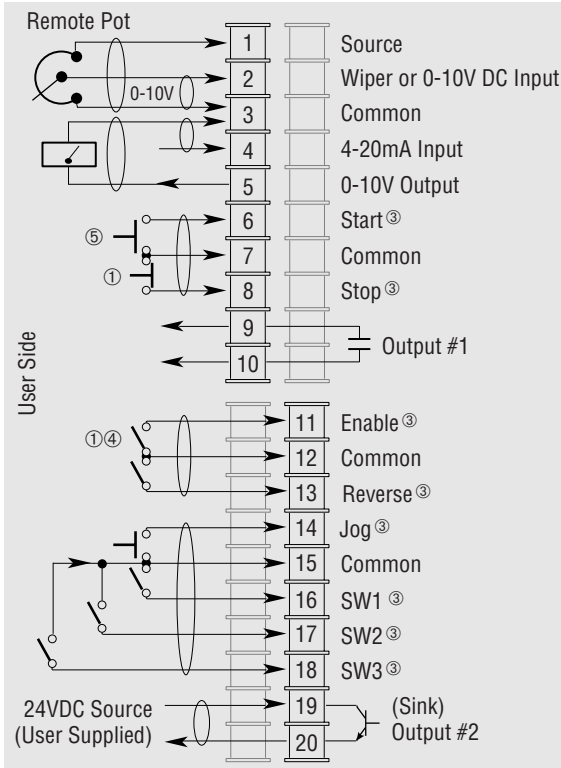

**See Table 2.F and Notes on page 2-21**

**Figure 2.8 TB2 Designations – Two Wire Control Operation**

[Input Mode]="Run Fwd/Rev" or [Input Mode]="Run F/R 2nd A"

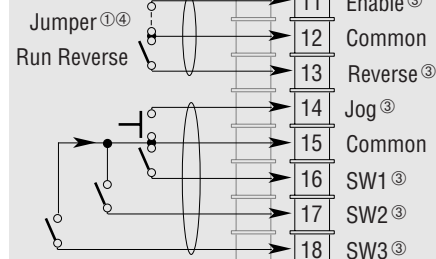
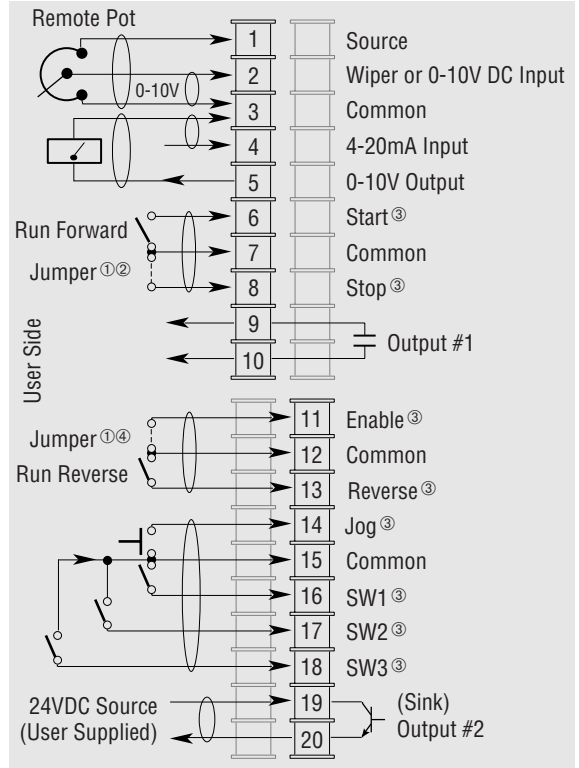

**Figure 2.9 TB2 Designations**  
 [Input Mode] = "3 Wire/MOP"

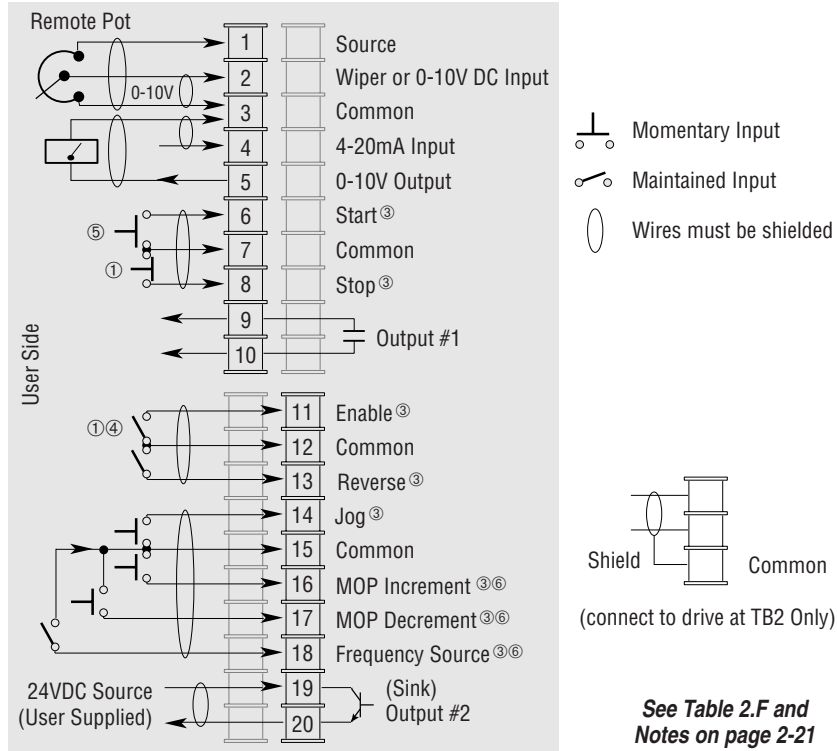

**Figure 2.10 TB2 Designations – Two Wire Control Operation**  
 [Input Mode] = "Run F/R MOP"

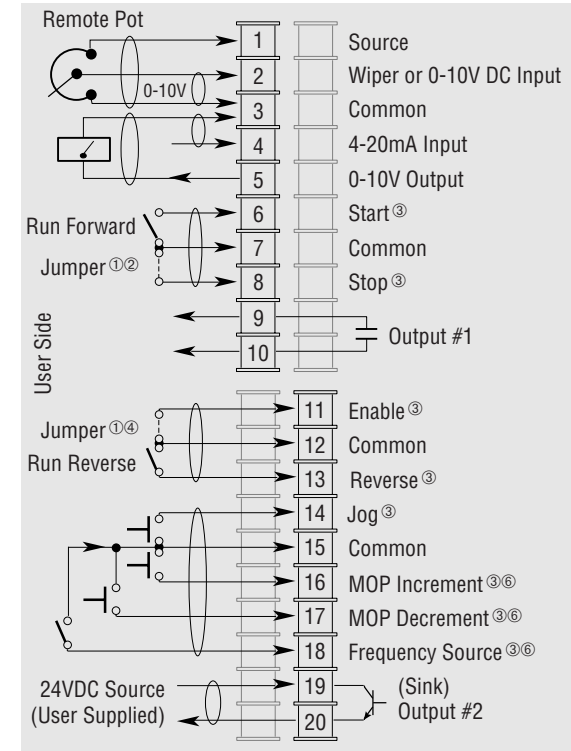

**See Table 2.F and Notes on page 2-21**

**Figure Notes:**

- ① Required to operate drive. STOP also used to clear a fault.
- ② Use HIM Stop button to clear faults.
- ③ Contact Closure Input. Internal 5V supply. DO NOT apply external voltage.
- ④ When the ENABLE signal is lost, the drive output immediately shuts off and the motor will coast to a stop.
- ⑤ A Start command will override any Jog command.
- ⑥ See Table 5.C on Page 5-31 for more information.

The recommended control signal wire is:

- Belden 8760 (or equiv.) - 18 AWG (0.750 mm<sup>2</sup>), twisted pair, shielded.
- Belden 8770 (or equiv.) - 18 AWG (0.750 mm<sup>2</sup>), 3 conductor, shielded.
- Belden 9460 (or equiv.) - 18 AWG (0.750 mm<sup>2</sup>), twisted pair, shielded.

**Important:** Control inputs to two or more drives must NOT be connected in parallel.

**Table 2.F Control Terminal Block (TB2) Descriptions**

Terminal	Signal	Specification
1, 2, 3	External Speed Pot	10 k $\Omega$ Potentiometer, 2 Watts
2,3	0-10V Analog Input	Drive Input Impedance = 100 k $\Omega$
4,3	4-20mA Analog Input	Drive Input Impedance = 250 $\Omega$
5, 3	0-10V Analog Output	Meter Impedance $\geq$ 4 k $\Omega$
6, 7	Start	Contact Closure Input ③
8, 7	Stop	Contact Closure Input ③
9, 10	Programmable Output 1	Resistive Rating = 115 V AC/30 VDC, 5A Inductive Rating = 115 V AC/30 VDC, 2A
11, 12	Drive Enable	Contact Closure Input ③④
13, 12	Reverse	Contact Closure Input ③
14, 15	Jog	Contact Closure Input ③
16, 15	SW1	Contact Closure Input ③
17, 15	SW2	Contact Closure Input ③
18, 15	SW3	Contact Closure Input ③
19, 20	Programmable Output 2	24V DC $\pm$ 20%, 50 mA Max. (Sink)

Recommended practice is to run all signal wiring in a separate steel conduit. The shield wire must only be connected at the drive.



**ATTENTION:** Signal common is internally connected to chassis ground. Do not use cable shields as signal current paths.

## OUTPUT DEVICES

### Drive Output Disconnection

---



**ATTENTION:** Any disconnecting means wired to drive output terminals U, V and W must be capable of disabling the drive if opened during drive operation. If opened during drive operation, the drive will continue to produce output voltage between U, V, W. An auxiliary contact must be used to simultaneously disable the drive or output component damage may occur.

---

## CABLE TERMINATION

### Optional Cable Terminator

Voltage doubling at motor terminals, known as reflected wave phenomenon, standing wave or transmission line effect, can occur when using drives with long motor cables.

Inverter duty motors with phase-to-phase insulation ratings of 1600 volts or higher should be used to minimize effects of reflected wave on motor insulation life.

Applications with non-inverter duty motors or any motor with exceptionally long leads may require an output inductor or cable terminator. An inductor or terminator will help limit reflection to the motor, to levels which are less than the motor insulation value.

Table 2.D lists the maximum recommended cable length for unterminated cables, since the voltage doubling phenomenon occurs at different lengths for different drive ratings. If your installation requires longer motor cable lengths, a reactor or cable terminator is recommended.

### Optional Output Reactor

The reactors listed in Catalog A111 can be used for the drive input and output. These reactors are specifically constructed to accommodate IGBT inverter applications with switching frequencies up to 20 kHz. They have a UL approved dielectric strength of 4000 volts, opposed to a normal rating of 2500 volts. The first two and last two turns of each coil are triple insulated to guard against insulation breakdown resulting from high dv/dt. When using output line reactors, it is recommended that the drive PWM frequency be set to its lowest value to minimize losses in the reactors. See Table 2.E.

**Important:** By using an output reactor the effective motor voltage will be lower because of the voltage drop across the reactor – this may also mean a reduction of the motor torque.

### Output Contactor

For application of an output contactor to a 1305 drive, please contact Allen-Bradley.

---

## ADAPTERS

An adapter is any device connected to the drive's serial port.

Typical devices include:

- Human Interface Modules
- Communication Modules
- Future adapter devices

**Important:** A maximum of five adapters can communicate to the drive.

**The total current draw of all adapters should not exceed 250mA.** Refer to the data sheet or nameplate of each adapter for the amount of current needed for the adapter to operate.

The Adapter address is determined as follows:

- Port 1 equals Adapter 1.
- Port 2 equals Adapter 2. However, if a splitter is used to expand the number of Adapters to 3, 4 or 5 the splitter will be marked with the appropriate Adapter numbers.

### Adapter Mounting Distance

The maximum mounting distance between any two adapters connected to the drive is 10 meters. Refer to Figure 2.11.

Figure 2.11 Adapter Mounting Distance and Cable Connections

Pull back connector to disconnect cable from the adapter device or Port 2 connection.

Refer to Appendix C for Cable recommendations.

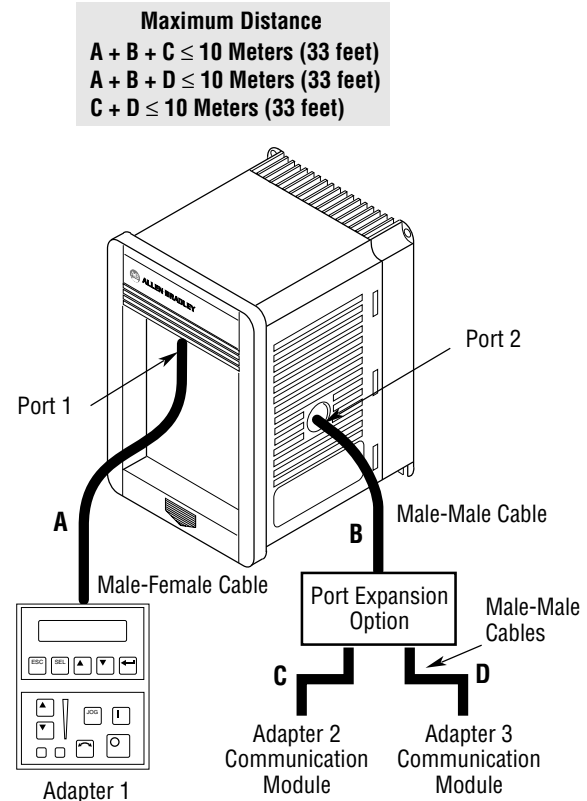
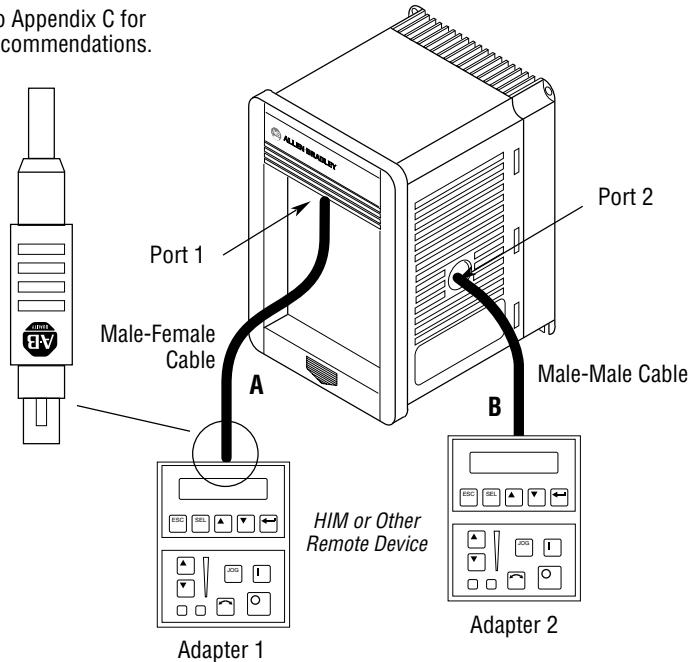

## CHAPTER OBJECTIVES

Chapter 3 describes the various controls and indicators found on the optional Human Interface Module (HIM) of the Bulletin 1305 AC Drive. The material presented in this chapter must be understood to perform the start-up procedure in Chapter 4.

## HIM DESCRIPTION

When the drive mounted HIM is supplied, it will be connected as Adapter 1 (see *Adapter* in Chapter 2) and visible from the front of the drive. The HIM can be divided into two sections; Display Panel and Control Panel. The Display Panel provides a means of programming the drive and viewing the various operating parameters. The Control Panel allows different drive functions to be controlled. Refer to Figure 3.1 and the sections that follow for a description of the panels.

**Important:** The operation of some HIM functions will depend upon drive parameter settings. The default parameter values allow full HIM functionality.

## HIM OPERATION

When power is first applied to the drive, the HIM will cycle through a series of displays. These displays will show drive name, HIM ID number and communication status. Upon completion, the Status Display will be shown. This display shows the current status of the drive (i.e. “Stopped,” “Running,” etc.) or any faults that may be present (“Serial Fault,” etc.). If the HIM software is Series A version 3.00 and

above or Series B version 1.01 and above (see back of HIM), the Status Display, Process Display or Password Login menu can be selected as the power-up display or menu. See appropriate sections on the following pages for more information.

Figure 3.1 Human Interface Module

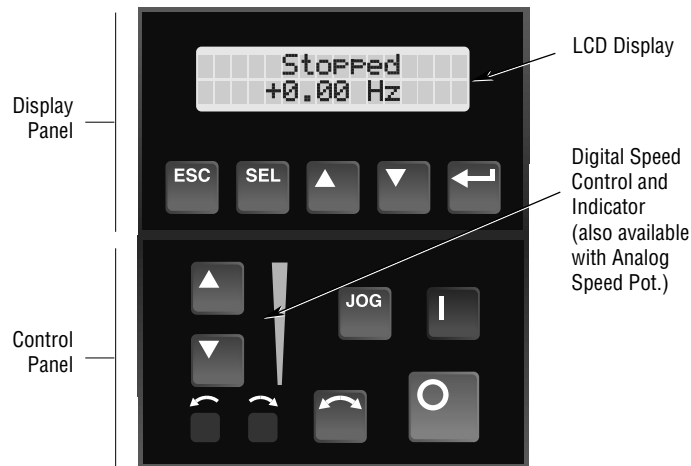

From this display, pressing any one of the five Display Panel keys will cause “Choose Mode” to be displayed. Pressing the Increment or Decrement keys will allow different modes shown in Figure 3.3.

## Display Panel Descriptions



### Escape

When pressed, the ESC key will cause the programming system to go back one level in the menu structure.



### Select

Pressing the SEL key alternately moves the cursor to the next active area. A flashing first character indicates which line is active.



### Increment/Decrement

These keys are used to increment and decrement a value or scroll through different groups or parameters.



### Enter

When pressed, a group or parameter will be selected or a parameter value will be entered into memory. After a parameter has been entered into memory, the top line of the display will automatically become active, allowing another parameter (or group) to be chosen.

## Control Panel Descriptions

**Important:** The following information is correct as shipped from the factory. Reprogramming of mask parameters can mask out control of some of these functions.



### Start

The Start key will initiate drive operation if no other control devices are sending a Stop command. This key can be disabled by the **[Logic Mask]** or **[Start Mask]**.



### Stop

If the drive is running, pressing the Stop key will cause the drive to stop, using the selected stop mode. Refer to the **[Stop Select]** in Chapter 5.

If the drive has stopped due to a fault, pressing this key will clear the fault and reset the drive. Refer to the **[Flt Clear Mode]**, **[Logic Mask]** and **[Fault Mask]** parameters.



### Jog

When pressed, jog will be initiated at the frequency set by the **[Jog Frequency]** parameter, if no other control devices are sending a Stop command. Releasing the key will cause the drive to stop, using the selected stop mode. Refer to **[Stop Select]**, **[Logic Mask]** and **[Jog Mask]**.

**Important:** If the drive is running prior to issuing a jog command, the jog command will be ignored.

**Important:** A start command from another source will override the jog command.

## Control Panel Descriptions *(continued)*



### Change Direction

Pressing this key will cause the drive to ramp down to 0 Hz and then ramp up to set speed in the opposite direction. The appropriate Direction Indicator will illuminate to indicate the direction of motor rotation. Refer to **[Logic Mask]** and **[Direction Mask]**. Note that the factory default for control of the reverse function is the reverse input at the TB2 control terminal block. To enable the HIM control of the reverse function, change Bit 0 of the **[Direction Mask]** parameter to "0" to disable the reverse function at TB2.



### Direction LEDs (Indicators)

These LEDs illuminate to indicate the direction of motor rotation.

		Rotating "Forward"
		Rotating "Reverse"
		Changing Direction, Decelerating "Reverse," will begin to Accelerate "Forward."
		Changing Direction, Decelerating "Forward," will begin to Accelerate "Reverse."



### Increment/Decrement Arrows

*(only available with digital speed control)*

Pressing these keys will increase or decrease the HIM frequency command. An indication of this command will be shown on the visual Speed Indicator LEDs. The drive will run at this command if the HIM is the selected frequency reference. See **[Freq Select 1/2]**.

Pressing both keys simultaneously stores the current HIM frequency command in HIM memory. The Speed Indicator LEDs will flash momentarily to indicate a successful save (if speed is above 20 percent). Cycling power or connecting the HIM to the drive will set the frequency command to the value stored in HIM memory.



If the Analog Speed Potentiometer option has been ordered, the Increment/Decrement keys and Speed Indicator will be replaced by the pot.

### Speed Indicator LEDs

*(only available with digital speed control)*

Illuminates in steps to give an approximate visual indication of the commanded speed.

If the Analog Speed Potentiometer option has been ordered, the Increment/Decrement keys and Speed Indicator LEDs will be replaced by the pot.

## HIM REMOVAL AND INSTALLATION

In addition to mounting directly on the drive, the HIM can be used as a hand held programmer or it can be mounted on the front of an enclosure. The HIM can be removed from the drive in one of two methods:

- A. Disconnect power from the drive and remove the HIM as outlined in steps 1 and 2, or
- B. Remove the HIM from the drive with the drive running, by masking out the **[Logic Mask]** bit that identifies the adapter address of the HIM. Refer to Figure 2.11 to identify the adapter address for the HIM or view the HIM ID# on the display as the unit is powered up. The ID # corresponds to the adapter address. Refer to page 5-47 for programming instructions on the **[Logic Mask]** parameter. For HIM software, Series A version 3.00 and above or Series B version 1.01 and above, you can enter the Control Status menu and Enable/Disable the Control Logic bit.

**Important:** If the **[Logic Mask]** bit of the adapter is not masked out (set to “0”), and the HIM is removed, a communication fault will occur and the drive will be disabled. However, if the HIM removed is the active frequency source, the drive will issue a “Hz Error” fault (F29).

**Important:** When the **[Logic Mask]** bit for an adapter is changed from “1” to “0” it disables all command functions for that adapter with the exception of the Stop command and frequency reference.

1. Lower the hinged panel located below the HIM.
2. Press the retaining lever located directly beneath the HIM, slide the HIM downward and remove it from the drive.
3. To reinsert the HIM, place the top edge of the HIM about 15 mm (1/2 in.) from the top edge of the cover. Push inward on the bottom of the HIM and slide the HIM up into position.

Figure 3.2 HIM Removal

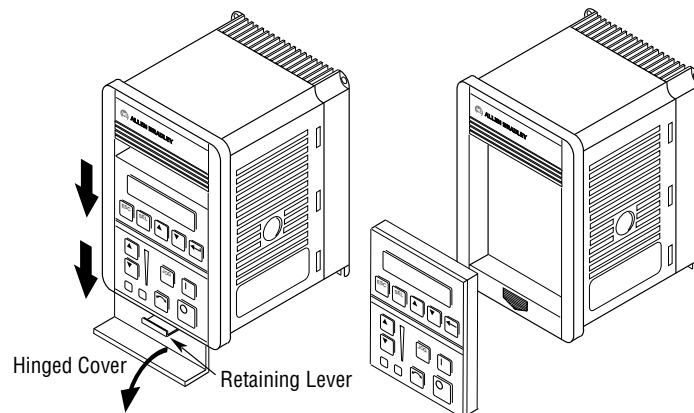

## HIM MODES

The HIM has up to seven different modes. Refer to Figure 3.3.

### Display

When selected, the Display mode allows any of the parameters to be viewed. However, parameter modifications are not allowed.

### Process

The Process mode allows a “configurable” display to be programmed. One user selected parameter can be displayed with programmed text and scaling. Refer to Chapter 5 for further information.

### Program

Program mode provides access to the complete listing of parameters available for programming. Refer to Chapter 5 for further parameter programming information.

### EEPROM

This mode allows all parameters to be reset to the factory default settings.

For Series B HIM Software Version 1.01 and Above, uploading and downloading of drive parameters may be performed.

### Search

*(Series A HIM, software V3.00 & up or Series B HIM, V1.01 & up Only)*

This mode will search for parameters that are not at their default values.

### Control Status

*(Series A HIM, software V3.00 & up or Series B HIM, V1.01 & up Only)*

Permits the [**Logic Mask**] parameter to be disabled/enabled allowing HIM removal while drive power is applied. This menu also provides access to a fault queue which will list the last four faults that have occurred. “Trip” displayed with a fault indicates the actual fault that tripped the drive. A clear function clears the queue.

**Important:** Clearing the Fault Queue will not clear an active fault.

### Password







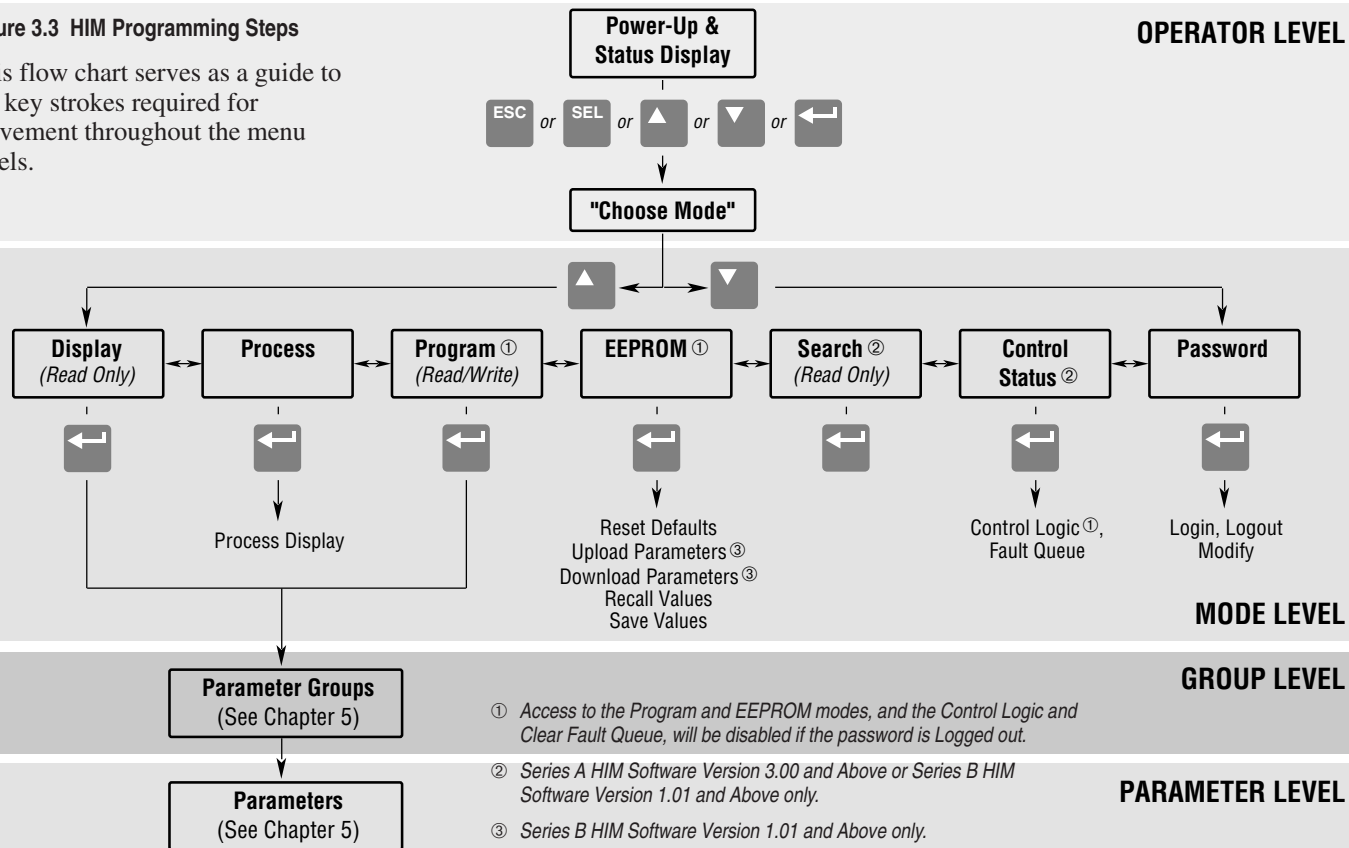

The Password mode protects the drive parameters against programming changes by unauthorized personnel. When a password has been assigned, access to the Program and EEPROM modes can only be gained when the correct password has been entered. The password can be any five digit number between 00000 and 65535. Refer to the example on page 3-17.

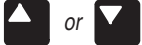
Figure 3.3 HIM Programming Steps

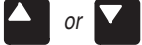

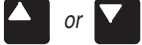
This flow chart serves as a guide to the key strokes required for movement throughout the menu levels.

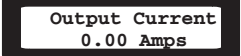

## PROGRAM AND DISPLAY MODES

ACTION	DESCRIPTION	HIM DISPLAY
     	<p>□ 1. The Display and Program modes allow access to the parameters for viewing or programming.</p> <p>a. From the Status Display, press Enter (or any key). “Choose Mode” will be shown.</p> <p>b. Press the Increment (or Decrement) key to show “Program” (or “Display”).</p> <p>c. Press Enter.</p> <p>d. Press the Increment (or Decrement) key until the desired group is displayed.</p> <p>e. Press Enter.</p> <p>f. Press the Increment (or Decrement) key to scroll to the desired parameter.</p>	   







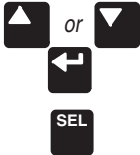
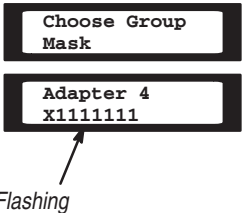



















PROGRAM AND DISPLAY MODES *(continued)*

ACTION	DESCRIPTION	HIM DISPLAY
<p data-bbox="82 219 253 245"><b>Changing Digits</b></p> <div data-bbox="99 400 237 519" style="text-align: center;">  or    </div>	<p data-bbox="300 219 1127 306">□ 2. With Series A HIM software versions 3.00 and above, or Series B HIM software version 1.01 and above, you have the ability to access and modify each individual bit or digit.</p> <p data-bbox="365 320 1122 375"><b>Important:</b> This procedure assumes the Password is not set, you have already logged in, or the device has been set to Defaults.</p> <ol data-bbox="365 400 992 519" style="list-style-type: none"> <li>a. Select a parameter with Increment (or Decrement) keys.</li> <li>b. Press the SEL key to view the first bit. Pressing this key again will move the cursor to the left one bit or digit.</li> </ol> <p data-bbox="393 543 1151 721">Individual bits of a Read/Write parameter can be changed. Pressing the SEL key will move the cursor (flashing character) one bit to the left. That bit can then be changed by pressing the Increment/Decrement keys. When the cursor is in the far right position, pressing the Increment/Decrement keys will increment or decrement the entire value.</p>	<div data-bbox="1214 384 1453 442" style="border: 2px solid black; padding: 2px; text-align: center;">Choose Group Setup</div> <div data-bbox="1214 458 1453 517" style="border: 2px solid black; padding: 2px; text-align: center;">Accel Time 99.9 Secs</div> <p data-bbox="1230 572 1393 599"><i>Flashing = Modify</i></p>



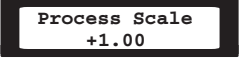











PROGRAM AND DISPLAY MODES *(continued)*

ACTION	DESCRIPTION	HIM DISPLAY
<p data-bbox="186 221 300 245"><b>Bit ENUMs</b></p>  <p data-bbox="178 356 313 404">▲ or ▼</p> <p data-bbox="219 399 267 446">←</p> <p data-bbox="224 462 267 511">SEL</p>	<p data-bbox="378 221 1203 306">□ 3. With Series A HIM software versions 3.00 and above, or Series B HIM software version 1.01 and above, bit ENUMs (16 character text strings) will be displayed to aid interpretation of bit parameters.</p> <p data-bbox="443 333 1193 386">a. From the Choose Group menu, use the Increment/Decrement key to select the Masks group. Press Enter.</p> <p data-bbox="443 423 1222 508">b. Press the SEL key to view the ENUM of the first bit. Pressing this key again will move the cursor to the left one bit or digit and view the next bit's ENUM.</p>	 <p data-bbox="1328 348 1479 391">Choose Group Mask</p> <p data-bbox="1328 423 1442 466">Adapter 4 x1111111</p> <p data-bbox="1284 529 1360 551"><i>Flashing</i></p>















## PROCESS MODE

ACTION	DESCRIPTION	HIM DISPLAY
 or    or    or    or     or      	<p>□ 1. When selected, the Process mode will show a custom display consisting of information programmed with the Process Display group of parameters.</p> <p>a. Complete steps <i>a – c</i> on page 3-7 to access the Program mode.</p> <p>b. Press the Increment/Decrement key until “Process Display” is shown. Press Enter.</p> <p>c. Using the Increment/Decrement keys, select [<b>Process Par</b>] and enter the number of the parameter you wish to monitor. Press Enter.</p> <p>d. Select [<b>Process Scale</b>] using the Increment/Decrement keys. Enter the desired scaling factor. Press Enter.</p> <p>e. Select [<b>Process Text 1</b>] using the Increment/Decrement keys. Enter the desired text character. Press Enter &amp; repeat for the remaining characters.</p> <p>f. When process programming is complete, press ESC until “Choose Mode” is displayed. Press Increment/Decrement until “Process” is displayed. Press Enter to get process value.</p> <p>g. With Series A HIM Software Versions 3.00 and above or Series B HIM Software Versions 1.01 and above, the user has the ability to save the Process Display for power up. To do this, simultaneously press Increment and Decrement keys on programming panel.</p>	      















## EEPROM MODE

ACTION	DESCRIPTION	HIM DISPLAY
<p><b>Reset Defaults</b></p> <p></p> <p> or </p> <p></p> <p> or </p> <p></p> <p></p> <p></p>	<p><input type="checkbox"/> 1. The EEPROM mode is used to restore all settings to factory default values or to upload or download parameters between the HIM and the drive. (Parameter upload or download requires a Series B HIM).</p> <p>To restore factory defaults:</p> <ol style="list-style-type: none"> <li>From the Status Display, press Enter (or any key). “Choose Mode” will be displayed.</li> <li>Press the Increment (or Decrement) key until “EEPROM” is displayed. If EEPROM is not in the menu, programming is password protected. Refer to <i>Password Mode</i> later in this section.</li> <li>Press Enter.</li> <li>Press the Increment (or Decrement) key until “Reset Defaults” is displayed.</li> <li>Press Enter to restore all parameters to their original factory settings.</li> <li>Press ESC. “Reprogram Fault” will display.</li> <li>Press the Stop key to reset the fault.</li> </ol> <p><b>Important:</b> If [Input Mode] was previously set to a value other than “1,” cycle drive power to reset.</p>	<p></p> <p></p> <p></p> <p></p> <p></p>









## EEPROM MODE (continued)

ACTION	DESCRIPTION	HIM DISPLAY
<p><b>Drive → HIM</b></p> <p> or </p> <p></p> <p>  or </p> <p></p> <p></p>	<p> 2. To upload a parameter profile from the drive to the HIM, you must have a Series B HIM.</p> <p>a. From the EEPROM menu, press the Increment/Decrement keys until “Drive → HIM” is displayed.</p> <p>b. Press Enter. Use the Increment/Decrement keys to choose between profile 1 or profile 2.</p> <p>c. To give a profile a name, use the SEL key to move the cursor right and use the Increment/Decrement keys to change the characters. When done, press Enter to save the name.</p> <p>d. Press Enter. An informational display will be shown, indicating the drive type and firmware version.</p> <p>e. Press Enter to start the upload. The parameter number currently being uploaded will be displayed on line 1 of the HIM. Line 2 will indicate total progress. Press ESC to stop the upload.</p> <p>f. A successful upload will be indicated by “Completed” displayed on line 2 of the HIM. Press Enter. If “Error” is displayed, see Chapter 6.</p>	<p></p> <p></p> <p></p> <p></p> <p></p> <p></p>













## EEPROM MODE (continued)

ACTION	DESCRIPTION	HIM DISPLAY
<p>HIM → Drive</p> <p> or </p> <p> </p> <p> or </p> <p></p> <p></p> <p></p>	<p>❑ 3. To download a parameter profile from the HIM to the drive, you must have a Series B HIM.</p> <p><b>Important:</b> The download function will only be available when there is a valid profile stored in the HIM.</p> <p>a. From the EEPROM menu, press the Increment/Decrement keys until “HIM → Drive” is displayed.</p> <p>b. Press the Enter key. A profile name will be displayed on line 2 of the HIM. Pressing the Increment/Decrement keys will scroll the display to a second profile (if available).</p> <p>c. Once the desired profile name is displayed, press the Enter key. An informational display will be shown, indicating the version numbers of the profile and drive.</p> <p>d. Press Enter to start the download. The parameter number currently being downloaded will be displayed on line 1 of the HIM. Line 2 will indicate total progress. Press ESC to stop the download.</p> <p>e. A successful download will be indicated by “Completed” displayed on line 2 of the HIM. Press Enter. If “Error” is displayed, see Chapter 6.</p>	<p></p> <p></p> <p></p> <p></p> <p></p>

## SEARCH MODE

ACTION	DESCRIPTION	HIM DISPLAY
<p><b>Search</b></p> <p></p> <p> or </p> <p></p> <p> or </p>	<p><input type="checkbox"/> 1. The Search mode is only available with Series A HIM software version 3.00 and above or Series B HIM software version 1.01 and above.</p> <p>This mode allows you to search through the linear parameter list and display all parameters that are not at the factory default values. The Search mode is a read only function.</p> <p>a. From the Status Display, press Enter (or any key). “Choose Mode” will be shown.</p> <p>b. Press the Increment (or Decrement) key until “Search” is displayed.</p> <p>c. Press Enter. The HIM will search through all parameters and display any parameters that are not at their factory default values.</p> <p>d. Press the Increment (or Decrement) key to scroll through the list.</p>	<p></p> <p></p>

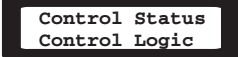
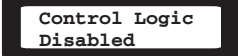

## CONTROL STATUS MODE

ACTION	DESCRIPTION	HIM DISPLAY
<p><b>Control Logic</b></p> <p></p> <p> or  </p> <p> or  </p> <p>  or </p> <p></p>	<p>❑ 1. The Control Status mode is only available with Series A HIM software version 3.00 and above or Series B HIM software version 1.01 and above.</p> <p>This mode allows the drive logic mask to be disabled, thus preventing a Serial Fault when the HIM is removed with drive power applied.</p> <p>a. From the Status Display, press Enter (or any key). “Choose Mode” will be shown.</p> <p>b. Press the Increment (or Decrement) key until “Control Status” is displayed. Press Enter.</p> <p>c. Select “Control Logic” using the Increment/Decrement keys. Press Enter.</p> <p>d. Press the SEL key, then use the Increment (or Decrement) key to select “Disabled” (or “Enable”).</p> <p>e. Press Enter. The logic mask is now disabled (or enabled).</p>	<p></p> <p></p> <p></p> <p></p>

## CONTROL STATUS MODE (continued)



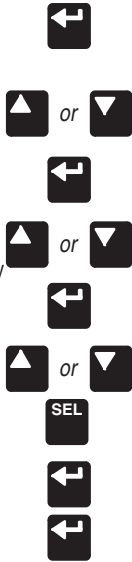





ACTION	DESCRIPTION	HIM DISPLAY
<p><b>Fault Queue/ Clear Faults</b></p> <p>▲ or ▼</p> <p>↵</p> <p>▲ or ▼</p> <p>↵</p> <p>▲ or ▼</p> <p>ESC ▲ or ▼</p> <p>↵</p>	<p>2. This menu provides a means to view the fault queue and clear it when desired.</p> <p>a. From the Control Status menu, press the Increment (or Decrement) key until “Fault Queue” is displayed.</p> <p>b. Press Enter.</p> <p>c. Press Increment (or Decrement) key until “View Faults” is displayed.</p> <p>d. Press Enter. The fault queue will be displayed. “Trip” displayed with a fault will indicate the fault that tripped the drive.</p> <p>e. Use the Increment (or Decrement) key to scroll through the list.</p> <p>f. To clear the fault queue, press ESC. Then use the Increment/Decrement keys to select “Clear Queue”. Press Enter.</p> <p><b>Important:</b> Clearing the Fault Queue will not clear an active fault.</p>	<p>Control Status Fault Queue</p> <p>Fault Queue View Faults</p> <p>Serial Fault F 10 Trip 1</p> <p>Buffer Number Location</p> <p>Fault Queue Clear Queue</p>

## PASSWORD MODE

ACTION	DESCRIPTION	HIM DISPLAY
<p><b>Setting Password</b></p>  <p>① Login Modify</p>	<p>❑ 1. The factory default password is 0 (which disables password protection). To change the password and enable password protection, perform the following steps.</p> <p>a. From the Status Display, press Enter (or any key). “Choose Mode” will be shown.</p> <p>b. Press the Increment (or Decrement) key until “Password” is displayed.</p> <p>c. Press Enter.</p> <p>d. Press the Increment (or Decrement) key until “Modify” is displayed.</p> <p>e. Press Enter. “Enter Password” will be displayed.</p> <p>f. Press the Increment (or Decrement) key to scroll to your desired new password. With Series A HIM software versions 3.00 and above or Series B HIM software version 1.01 and above, the SEL key allows each digit to be selected and changed individually.</p> <p>g. Press Enter to save your new password.</p> <p>h. Press Enter again to return to the Password Mode.</p>	











① Login is used to enter the password for access to the Program, Control Logic, Clear Fault Queue, and EEPROM modes.

**PASSWORD MODE** *(continued)*





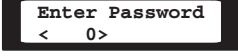
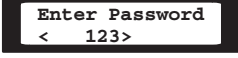



ACTION	DESCRIPTION	HIM DISPLAY
<p data-bbox="56 228 267 271">② Logout  or </p> <p data-bbox="178 276 235 324"></p> <p data-bbox="170 329 235 345">Press</p> <p data-bbox="48 361 292 409">    </p>	<p data-bbox="365 218 1120 250">i. Press the Increment (or Decrement) key until “Logout” is displayed.</p> <p data-bbox="365 276 876 308">j. Press Enter to log out of the Password mode.</p> <p data-bbox="365 340 1153 494">k. With Series A HIM software versions 3.00 and above or Series B HIM software version 1.01 and above, the Password Login menu can be programmed to appear when drive power is applied. To save the Password Login menu as the power-up menu, simultaneously press the Increment and Decrement keys while the Password display is active.</p>	<div data-bbox="1218 218 1453 276" style="border: 2px solid black; padding: 5px; text-align: center;"> <p data-bbox="1242 228 1347 271">Password Logout</p> </div> <div data-bbox="1218 292 1453 351" style="border: 2px solid black; padding: 5px; text-align: center;"> <p data-bbox="1242 303 1380 345">Choose Mode Password</p> </div>

② Logout is used to disable access to the Program, Control Logic, Clear Fault Queue, and EEPROM modes.

**PASSWORD MODE** *(continued)*

ACTION	DESCRIPTION	HIM DISPLAY
<p data-bbox="149 221 337 245"><b>Login to the Drive</b></p> <div data-bbox="180 423 310 469">  or  </div> <div data-bbox="224 487 269 533">  </div> <div data-bbox="224 551 269 596">  </div> <div data-bbox="180 604 310 650">  or  </div> <div data-bbox="224 732 269 777">  </div>	<p data-bbox="378 221 1222 306">□ 2. The Program and EEPROM modes, and the Clear Fault Queue menu, are now password protected and will not appear in the menu. To access these modes, perform the following steps.</p> <p data-bbox="443 330 1227 384">a. From the Status Display, press Enter (or any key). “Choose Mode” will be shown.</p> <p data-bbox="443 423 1222 447">b. Press the Increment (or Decrement) key until “Password” is displayed.</p> <p data-bbox="443 487 886 511">c. Press Enter. “Login” will be displayed.</p> <p data-bbox="443 551 989 575">d. Press Enter, “Enter Password” will be displayed.</p> <p data-bbox="443 614 1219 724">e. Press the Increment (or Decrement) key until your correct password is displayed. With Series A HIM software versions 3.00 and above or Series B HIM software version 1.01 and above, the SEL key allows each digit to be selected and changed individually.</p> <p data-bbox="443 763 599 788">f. Press Enter.</p> <p data-bbox="443 827 1222 880">g. The Program and EEPROM modes will now be accessible. To prevent future access to program changes, Logout as described in step 3.</p>	<div data-bbox="1292 412 1528 469">  </div> <div data-bbox="1292 487 1528 543">  </div> <div data-bbox="1292 551 1528 607">  </div> <div data-bbox="1292 614 1528 671">  </div> <div data-bbox="1292 724 1528 780">  </div>

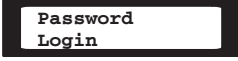
**PASSWORD MODE** *(continued)*

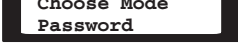
ACTION	DESCRIPTION	HIM DISPLAY
<p><b>Logout from the Drive</b></p> <p>  or      or    </p>	<p>□ 3. To prevent unauthorized changes to parameters, Logout must be performed as described below.</p> <p>a. From the Status Display, press Enter (or any key). “Choose Mode” will be shown.</p> <p>b. Press the Increment (or Decrement) key until “Password” is displayed.</p> <p>c. Press Enter.</p> <p>d. Press the Increment (or Decrement) key until “Logout” is displayed.</p> <p>e. Press Enter to log out of the Password mode.</p>	   

## CHAPTER OBJECTIVES

This chapter describes the steps needed to start-up the drive. Included in the procedure are typical adjustments and checks to assure proper operation. The information contained in previous chapters of this manual must be read and understood before proceeding.

**Important:** The drive is designed so that start-up is simple and efficient. The programmable parameters are grouped logically so that most start-ups can be accomplished by adjusting parameters in only one group. Advanced features and adjustments are grouped separately. This eliminates having to step through unneeded parameters on initial start-up.

This start-up procedure covers only those most commonly adjusted values, all of which appear in the Setup Group.

## START-UP PROCEDURE

The following start-up procedure is written for users who have a Human Interface Module (HIM) installed in the drive (Port 1). For users without a HIM, external commands and signals must be substituted.

**Important:** The parameters in the Set Up Group (page 5-8) should be reviewed and reprogrammed as necessary for basic operation.



**ATTENTION:** Power must be applied to the drive to perform the following start-up procedure. Some of the voltages present are at incoming line potential. To avoid electric shock hazard or damage to equipment, only qualified service personnel should perform the following procedure. Thoroughly read and understand the procedure before beginning. If an event does not occur while performing this procedure, **Do Not Proceed. Remove Power** by opening the branch circuit disconnect device and correct the malfunction before continuing.

### Important:

- Power must be applied to the drive when viewing or changing parameters. Previous programming may effect the drive status when power is applied.
- Confirm that all circuits are in a de-energized state before applying power. User supplied voltages may exist at TB2 even when power is not applied to the drive.
- Refer to Chapter 6 for fault code information.

### Initial Operation - Motor Disconnected

- ❑ 1. Verify that AC line power at the disconnect device is within the rated value of the drive.
- ❑ 2. Disconnect and lock-out all incoming power to the drive including incoming AC power to terminals L1, L2 and L3 (R, S and T) plus any separate control power for remote interface devices. Remove the drive cover and verify the motor leads are disconnected from the Power Terminal Block (TB1), terminals T1, T2 and T3 (U, V, W). Refer to Chapter 2 for terminal location.



**ATTENTION:** Proceed with caution. A DC bus voltage may be present at the Power Terminal Block (TB1) even when power is removed from the drive.

- ❑ 3. Verify that the Stop and Enable inputs are connected.
- ❑ 4. Confirm that all other optional inputs are connected to the correct terminals and are secure.
- ❑ 5. If the HIM has a Control Panel, use the local controls to complete the start-up procedure. If a Control Panel is not present, remote devices must be used to operate the drive.
- ❑ 6. Replace the drive cover.

ACTION	DESCRIPTION	HIM DISPLAY
Apply Power to Drive	<ul style="list-style-type: none"> <li>❑ 7. When power is first applied to the drive, the following information will be momentarily displayed:               <ul style="list-style-type: none"> <li>a.) The HIM ID# (Adapter #) and firmware version number.</li> <li>b.) Communication status.</li> <li>c.) Series letter of drive is displayed.</li> <li>d.) The LCD Display should light and display a drive status of “Stopped” and an output frequency of “+0.00 Hz.”</li> </ul> </li> </ul>	

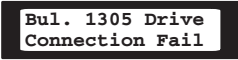
	<input type="checkbox"/> 8. If the HIM and drive are not communicating properly, “Connection Fail” may be displayed on line 2. If this occurs remove the HIM from the drive and reinsert. See Page 3-4 for HIM Removal instructions. If this does not correct the problem or another fault message is displayed, record the information and remove all power. Determine and correct the fault source before proceeding. Refer to Chapter 6 for fault descriptions.	
Reset Factory Defaults	<input type="checkbox"/> 9. <b>Important:</b> The remaining steps in this procedure are based on factory default parameter settings. If the drive has been previously operated, parameter settings may have been changed and may not be compatible with this start-up procedure or application. Refer to page 3-11 to reset to factory defaults.	
[Input Mode] Selection	<input type="checkbox"/> 10. The factory default <b>[Input Mode]</b> is “3 wire” control as described in Chapter 2. If the factory default setting is sufficient, then skip to Step 11. If another control scheme is desired, change the <b>[Input Mode]</b> parameter by performing the following procedure.	

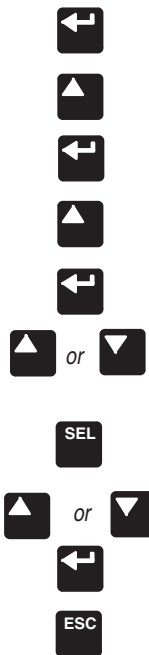

#### □ 10. INPUT MODE SELECTION (continued)

- a.) From the Status Display, press the Enter key (or any key). “Choose Mode” will be displayed.
- b.) Press the Increment (or Decrement) key until “Program” is displayed.
- c.) Press Enter. The parameter group “Metering” will be displayed.
- d.) Press the Increment key again until the “Set Up” Group is displayed.
- e.) Press Enter.
- f.) Press the Increment or Decrement key until the **[Input Mode]** parameter is displayed.
- g.) Press SEL. The first character of line 2 will now flash.
- h.) Press the Increment or Decrement key until the correct mode is displayed, then press enter. The first character of line 1 should now be flashing.
- i.) Press the ESC key (3 times) to return to the Status Display.

**Important:** If the **[Input Mode]** is changed, power must be cycled for the change to take effect.

Choose Mode  
Display

Choose Mode  
Program

Choose Group  
Metering

Choose Group  
Set Up

Input Mode  
3 Wire

Input Mode  
3 Wire

Input Mode  
Run Fwd/Rev

Stopped  
+0.00 Hz

□ 11. Setting Frequency Command to 0 Hz

If the HIM has an analog potentiometer option, turn the potentiometer fully counter clockwise and skip to Step 12.

If the HIM has Digital Up-Down keys for frequency control then perform the following:

- a.) From the Status Display, press the Enter key (or any key). “Choose Mode” will be displayed.
- b.) Press the Increment or Decrement key until “Display” is shown.
- c.) Press Enter.
- d.) Press the Increment or Decrement key again until “Metering” is displayed.
- e.) Press Enter.
- f.) Press the Increment or Decrement key until [Freq Command] is displayed.
- g.) If the frequency command is a value other than 0 Hz, use the speed source (digital up-down keys on Control Panel) to set the command to 0 Hz.
- h.) After the command has been set to 0 Hz, press the ESC key until the Status Display is shown.

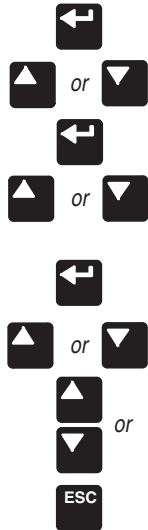

Choose Mode  
Program

Choose Mode  
Display













Choose Group  
Set Up

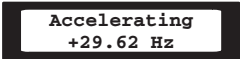





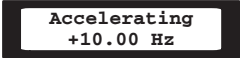







Choose Group  
Metering

Output Current  
0.00 Amps

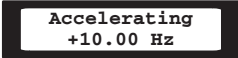
Freq Command  
+0.00 Hz

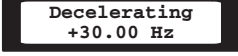
Stopped  
+0.00 Hz

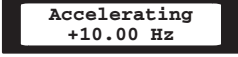
  or 	<p>□ 12. Verifying Minimum and Maximum Frequency Settings.</p> <p>a.) Press the Start key. The drive should output 0 Hz, which is the factory default value for the [<b>Minimum Freq</b>] parameter. The Status Display should indicate “At Speed” and the actual frequency (+0.00 Hz.).</p> <p>b.) With the drive still running, use the speed source to command maximum speed. The drive should ramp to 60 Hz, which is the factory default value for the [<b>Maximum Freq</b>] parameter.</p>	    
<p>Open Enable Signal Restore Enable Signal</p>   	<p>□ 13. Enable interlock check.</p> <p>The following steps check for correct drive operation when the Enable input is removed. Refer to Chapter 2 for terminal designations.</p> <p>a.) With the drive still running, open the Enable signal. The drive should stop and indicate “Not Enabled” on the Display Panel. Restore the Enable signal.</p> <p>b.) Restart the drive by pressing the Start key.</p> <p>c.) Stop the drive.</p>	      

<p>Press &amp; Hold Jog Key</p>  <p>Release Jog Key</p>	<p><input type="checkbox"/> 14. Jog Control Check.</p> <p>a.) With the drive stopped, press and hold the JOG key on the Control Panel. The drive should accelerate to the frequency programmed by the [<b>Jog Frequency</b>] parameter and remain there until the JOG key is released. When released, the drive should “Ramp to Stop” which is the factory default stopping method for the [<b>Stop Select</b>] parameter.</p>	 
<p>Set to Maximum Frequency</p>  <p>or</p>    	<p><input type="checkbox"/> 15. Checking Accel and Decel Times.</p> <p>a.) Start the drive and use the speed source to command maximum frequency.</p> <p>b.) Press the Stop key and estimate the amount of time the drive takes to decelerate from 60 Hz to 0 Hz. This time should equal the time set in the [<b>Decel Time I</b>] parameter (default is 10 seconds). If these times are not correct for your application, refer to Chapter 5 for instructions on programming changes.</p> <p>c.) Start the drive and estimate the amount of time the drive takes to accelerate to maximum frequency. This should equal 10 seconds, which is the factory default value for the [<b>Accel Time 1</b>] parameter.</p> <p>d.) Stop the drive.</p>	     

Remove ALL Power

Reconnect Motor

□ 16. Reconnect the Motor.



**ATTENTION:** Proceed with caution. A DC Bus Voltage may be present at the Power Terminal Block (TB1) even when power is removed from the drive.

- a.) Disconnect and lock-out all input and control power to the drive. When the HIM Display is no longer illuminated, remove the drive cover.
- b.) Verify that the DC Bus neon indicator is not illuminated (See Figure 2.3 for location) and wait 60 seconds. Reconnect the motor leads to the drive and replace the drive cover.

**Important:** The parameters in the Set Up Group (page 5-8) should be reviewed and reprogrammed as necessary for basic operation.



**ATTENTION:** In the following steps, rotation of the motor in an un-desired direction can occur. To guard against possible equipment damage, it is recommended that the motor be disconnected from the load before proceeding.



**Apply Power to Drive**

Verify Frequency  
Command = 0

**Slowly Increase Speed**

Verify Direction  
of Rotation





 17. Check for Correct Motor Rotation.

- a.) Reapply power to the drive.
- b.) Verify that the frequency command is at zero Hz. Refer to step 11 for further information.
- c.) Start the drive.
- d.) *Slowly* increase the speed until the motor begins to turn. Check the direction of motor rotation.
- e.) Stop the drive. If the direction of rotation is as desired, proceed to step 18.

If the direction of rotation is incorrect - disconnect and lock-out all input and control power to the drive. When the HIM Display is no longer illuminated, remove the drive cover. Verify that the DC Bus neon indicator is not illuminated (see Figure 2.3 for location) and wait 60 seconds. Interchange any two of the three motor leads at TB1 terminals, T1, T2 or T3. Replace the drive cover and repeat steps *a – e* to verify correct motor rotation.

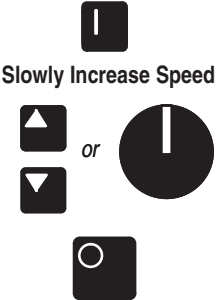
At Speed  
+5.00 Hz

Stopped  
+0.00 Hz

 <p>Slowly Increase Speed</p>	<p><input type="checkbox"/> 18. Check for proper operation.</p> <p>a.) Start the drive.</p> <p>b.) <i>Slowly</i> increase the speed. Check for proper motor operation throughout the speed range.</p> <p>c.) Press the Stop key.</p>	  
	<p><input type="checkbox"/> 19. This completes the basic start-up procedure. Depending on your application, further parameter programming may be required. Refer to Chapter 5 for information.</p> <p><b>Important:</b> The parameters in the Set Up Group (page 5-8) should be reviewed and reprogrammed as necessary for basic operation.</p>	

## CHAPTER OBJECTIVES

Chapter 5 describes the 1305 parameters which are divided into groups for ease of programming and operator access. Grouping replaces a sequentially numerical parameter list with functional parameter groups that increases operator efficiency and helps to reduce programming time. For most applications, this means simplicity at startup with minimum drive tuning.

## CHAPTER CONVENTIONS

1. All parameters required for any given drive function will be contained within a group, eliminating the need to change groups to complete a function.
2. To help differentiate parameter names and display text from other text in this manual, the following conventions will be used – Parameter Names will appear in **[Brackets]** – Display Text will appear in “Quotes.”
3. Parameter information in this chapter is presented for users who have a Human Interface Module (HIM) installed. For those users without a HIM installed, the drive can be operated using the factory default values for each parameter or parameter values can be changed through the serial port.

## FUNCTION INDEX

The Function Index shown provides a directory of various drive functions. The Page Number will direct you to the parameters associated with each function.

Function	Page #	Function	Page #
Accel/Decel Time	5-9	Min/Max Freq.	5-10, 5-11, 5-15
Accel/Decel Selection	5-30	MOP	5-6, 5-8, 5-28, 5-49, 5-53
Analog Invert	5-21	Output Configuration	5-37
Auto-Restart/ Run On Power Up	5-32	Overload Protection	5-12
Current Limiting	5-11, 5-13	Preset Frequencies	5-25, 5-27, 5-29
Custom Volts/Hz	5-17	Process Display	5-55
DC Boost	5-17, 5-18, 5-19	PWM Freq. Derating	5-20
DC Brake-to-Stop	5-22, 5-23	Ramp to Stop	5-22
Fan/Pump Volts/Hz	5-18	S-Curve Acceleration	5-33, 5-34
Fault Buffer History	5-39	Skip Frequencies	5-27, 5-28
Frequency Select	5-25	Standard Boost V/Hz	5-18
Freq. Source Select	5-29	Standard Volts/Hz	5-16
Line Loss Fault	5-40, 5-41	Start/Run Boost	5-19

## PARAMETER FLOW CHART

The chart provided on pages 5-2 and 5-3 highlights each group of parameters and lists all parameters for each of the 13 groups. Parameters that appear in more than one group are shown in bold. Parameter numbers are shown in parenthesis immediately after the parameter name. An example of how to program a parameter is shown on page 5-4.

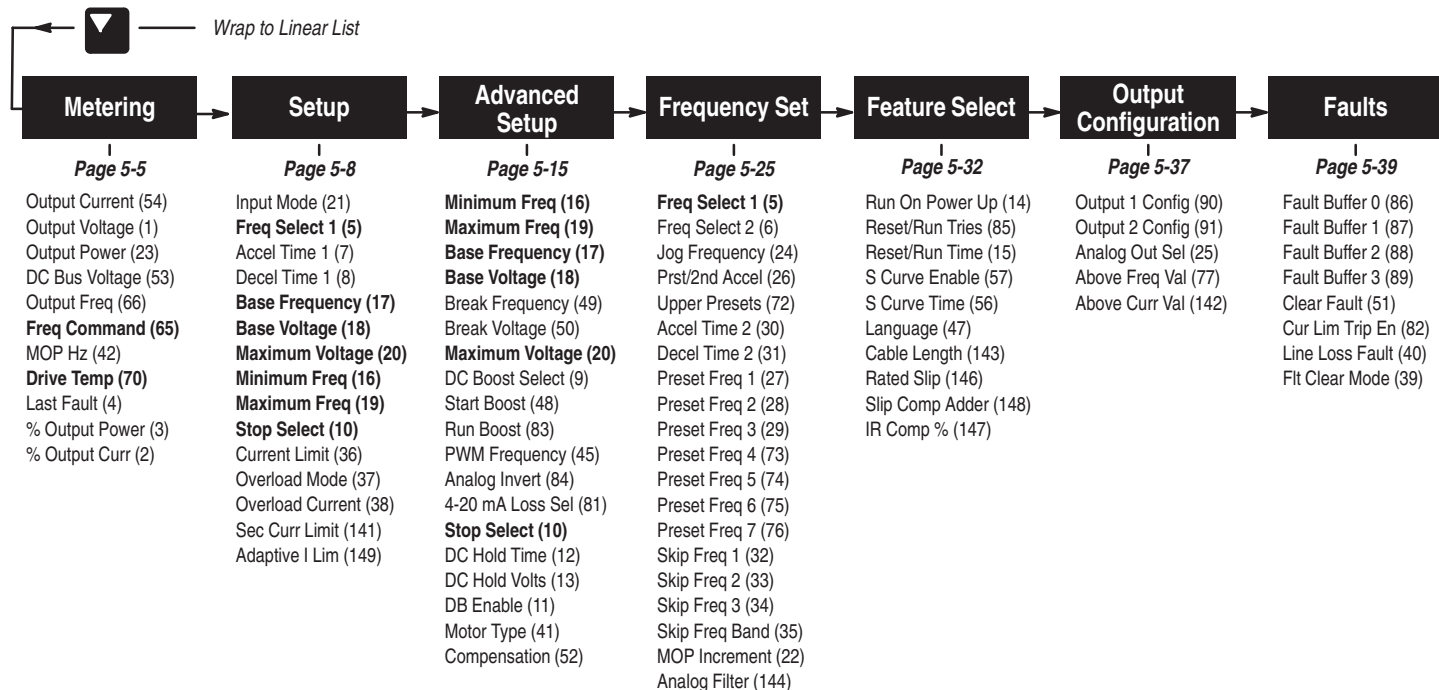



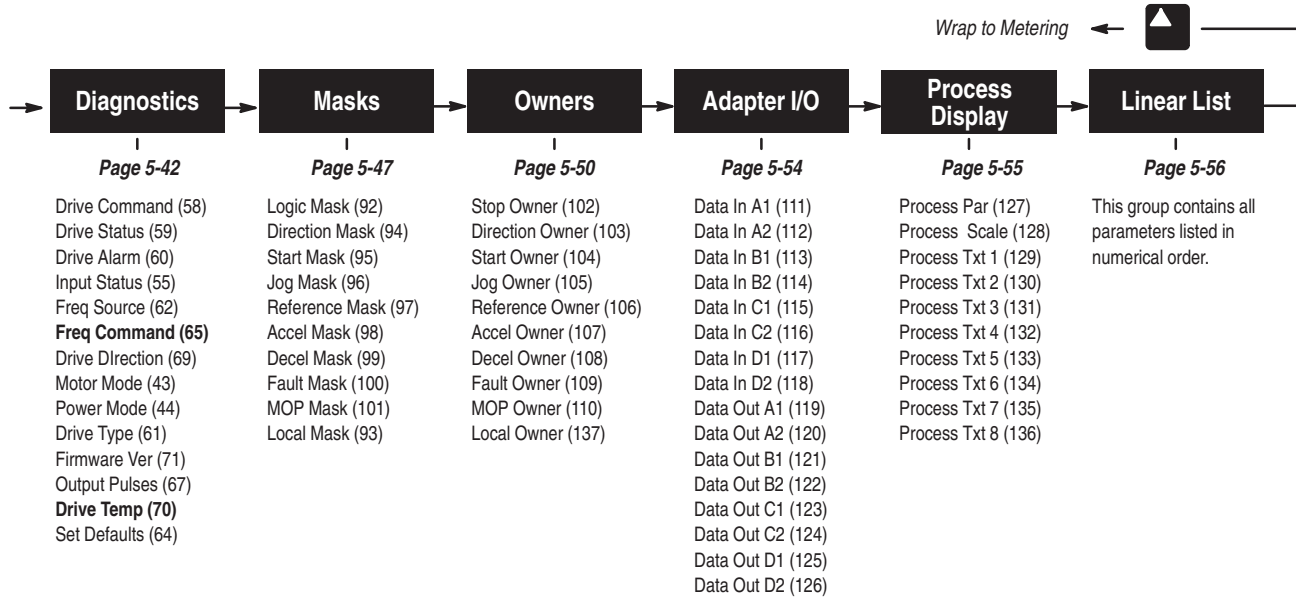









**Bold** indicates parameters located in more than one group.



## PROGRAMMING EXAMPLE

The following is an example of the programming steps required to change a parameter setting. In this example, the parameter **[Freq Select 1]** is being programmed from its' factory default setting of "Adapter 1" to a new setting, "Adapter 2".

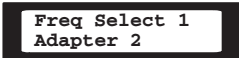
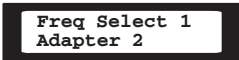
ACTION	DESCRIPTION	HIM DISPLAY
 <p>To Select Mode</p>  <p>or</p> 	<p><input type="checkbox"/> 1. Press any key to go from the Status Display to the "Choose Mode" menu.</p> <p><input type="checkbox"/> 2. Press the Up/Down keys until "Program" appears on the display.</p> <p><input type="checkbox"/> 3. Press the Enter key to go to the "Program" menu.</p>	 
<p>To Select a Group</p>  <p>or</p> 	<p><input type="checkbox"/> 4. Press the Up/Down keys until "Setup" appears on the display.</p> <p><input type="checkbox"/> 5. Press the Enter key to go to the "Setup" menu.</p>	
<p>To Select a Parameter within a Group</p>  <p>or</p> 	<p><input type="checkbox"/> 6. Press the Up/Down keys until <b>[Freq Select 1]</b> appears on the display.</p> <p><input type="checkbox"/> 7. Press the SEL key. The first character of line 2 will flash indicating the parameter setting/value can be changed.</p>	
<p>To Change a Parameter Setting or Enter a Value</p>  <p>or</p> 	<p><input type="checkbox"/> 8. Press the Up/Down keys until "Adapter 2" appears on the display.</p> <p><input type="checkbox"/> 9. Press the Enter key to program <b>[Freq Select 1]</b> to "Adapter 2."</p>	 

**Metering**

This group of parameters consists of commonly viewed drive operating conditions such as drive output frequency, output voltage, output current and command frequency. All parameters in this group are Read Only.

<p><b>[Output Current]</b></p> <p>This parameter displays the output current present at TB1, terminals T1, T2 &amp; T3 (U, V &amp; W).</p>	<p><b>Parameter #</b> 54  <b>Parameter Type</b> Read Only  <b>Units</b> 0.01 Amps</p>	<p><b>Factory Default</b> None  <b>Minimum</b> 0.00  <b>Maximum</b> Two Times Drive Output Current</p>
<p><b>[Output Voltage]</b></p> <p>This parameter displays the output voltage present at TB1, terminals T1, T2 &amp; T3 (U, V &amp; W).</p>	<p><b>Parameter #</b> 1  <b>Parameter Type</b> Read Only  <b>Units</b> 1 Volt</p>	<p><b>Factory Default</b> None  <b>Minimum</b> 0  <b>Maximum</b> Maximum Voltage</p>
<p><b>[Output Power]</b></p> <p>This parameter displays the output power present at TB1, terminals T1, T2, &amp; T3 (U, V &amp; W).</p>	<p><b>Parameter #</b> 23  <b>Parameter Type</b> Read Only  <b>Units</b> 0.01 kW</p>	<p><b>Factory Default</b> None  <b>Minimum</b> 0  <b>Maximum</b> Two Times Rated Drive Output Power</p>
<p><b>[DC Bus Voltage]</b></p> <p>This parameter displays the DC bus voltage level.</p>	<p><b>Parameter #</b> 53  <b>Parameter Type</b> Read Only  <b>Units</b> 1 Volt</p>	<p><b>Factory Default</b> None  <b>Minimum</b> 0  <b>Maximum</b> 410 - 230V Drive          815 - 460V Drive</p>

**Metering Group** (continued)

<p><b>[Output Freq]</b></p> <p>This parameter displays the output frequency present at TB1, terminals T1, T2 &amp; T3 (U, V &amp; W).</p>	<p><b>Parameter #</b> 66  <b>Parameter Type</b> Read Only  <b>Units</b> 0.01 Hz</p>	<p><b>Factory Default</b> None  <b>Minimum</b> – [Maximum Freq]  <b>Maximum</b> + [Maximum Freq]</p>
<p><b>[Freq Command]</b></p> <p>This parameter displays the frequency that the drive is commanded to output. This command may come from any one of the frequency sources selected by <b>[Freq Select 1]</b>, <b>[Freq Select 2]</b> or <b>[Preset Freq 1-7]</b> the preset speeds 1-7 as determined by the inputs to SW1, SW2, and SW3 at TB2.</p>	<p><b>Parameter #</b> 65  <b>Parameter Type</b> Read Only  <b>Units</b> 0.01 Hz</p>	<p><b>Factory Default</b> 0.00 Hz  <b>Minimum</b> 0.00 Hz  <b>Maximum</b> +400.00 Hz</p>
<p><b>[MOP Hz]</b></p> <p>This parameter displays the frequency reference commanded by the Motor Operated Potentiometer (MOP) function. This MOP frequency command can be adjusted from TB2-16 and TB2-17 if the appropriate <b>[Input Mode]</b> is selected. This MOP frequency command can also be changed through serial communication. This value is displayed regardless of whether or not this is the active frequency command.</p>	<p><b>Parameter #</b> 42  <b>Parameter Type</b> Read Only  <b>Units</b> 0.01 Hz</p>	<p><b>Factory Default</b> None  <b>Minimum</b> 0.00 Hz  <b>Maximum</b> 400.00 Hz</p>

**Metering Group** *(continued)*

<p><b>[Drive Temp]</b></p> <p>This parameter displays the drive internal temperature.</p>	<p><b>Parameter #</b> 70  <b>Parameter Type</b> Read Only  <b>Units</b> 1°C</p>	<p><b>Factory Default</b> None  <b>Minimum</b> 0  <b>Maximum</b> 100°C</p>
<p><b>[Last Fault]</b></p> <p>This parameter displays the fault code for the present drive fault. If there is no active fault, the value will be zero.</p>	<p><b>Parameter #</b> 4  <b>Parameter Type</b> Read Only  <b>Units</b> Numeric</p>	<p><b>Factory Default</b> None  <b>Minimum</b> 0  <b>Maximum</b> Max. Fault Number</p>
<p><b>[% Output Power]</b></p> <p>This parameter displays the percent of drive rated output power.</p>	<p><b>Parameter #</b> 3  <b>Parameter Type</b> Read Only  <b>Units</b> 1 %</p>	<p><b>Factory Default</b> None  <b>Minimum</b> 0 %  <b>Maximum</b> 200% Drive Rated Power</p>
<p><b>[% Output Curr]</b></p> <p>This parameter displays the percent of drive rated output current.</p>	<p><b>Parameter #</b> 2  <b>Parameter Type</b> Read Only  <b>Units</b> 1 %</p>	<p><b>Factory Default</b> None  <b>Minimum</b> 0 %  <b>Maximum</b> 200% of Rated Drive Output Current</p>

## Setup

This group of parameters defines the basic operation of the drive and should be programmed before initial operation. For advanced programming and information on specific parameters, refer to the flow chart on page 5-2 & 5-3

**[Input Mode]**

This parameter selects between Three Wire and Run Fwd/Rev control. Refer to Chapter 2, Figure 2.7 through Figure 2.10.

**Important:** Power must be cycled to the drive for the change to take effect.

**Important:** See Frequency Set Group for MOP explanation.

<b>Parameter #</b>	21	<b>Factory Default</b>	"Three Wire"	
<b>Parameter Type</b>	Read & Write	<b>Setting</b>	"Three Wire"	
<b>Units</b>	Text		"Run Fwd/Rev"	
			"3 W/2nd Acc" (2nd Accel)	
			"Run F/R 2nd A" (2nd Accel)	
			"3 Wire/MOP"	
			"Run F/R MOP"	
		<b>Important:</b>	This parameter cannot be programmed while the drive is running.	

**[Freq Select 1]**

This parameter is the factory default parameter for selecting the frequency source that will supply the **[Freq Command]** to the drive. **[Freq Select 2]** or **[Preset Freq 1-7]** can be selected in place of this parameter with proper terminal block inputs. (See Chart on Page 5-29).

**Important:** If an adapter that is not connected is selected as the active frequency source, the drive will fault on "Hz Sel Fault" (F30).

<b>Parameter #</b>	5	<b>Factory Default</b>	"Adapter 1"	
<b>Parameter Type</b>	Read & Write	<b>Settings</b>	"Remote Pot"	"Preset 1"
<b>Units</b>	Text		"0-10 Volt"	"Preset 2"
			"4-20 mA"	"Preset 3"
			"MOP"	"Preset 4"
			"Adapter 1"	"Preset 5"
			"Adapter 2"	"Preset 6"
			"Adapter 3"	"Preset 7"
			"Adapter 4"	
			"Adapter 5"	
			"Adapter 6"	

**Setup Group** (continued)

**[Accel Time 1]**

This parameter is the factory default parameter for determining the time it will take the drive to ramp from 0 Hz to **[Maximum Frequency]**. The rate is linear unless **[S Curve]** is "Enabled." It applies to any increase in command frequency. The **[Accel Time 2]** parameter can be selected in place of this parameter. (See Chart on Page 5-30).

<b>Parameter #</b>	7	<b>Factory Default</b>	10.0 Sec
<b>Parameter Type</b>	Read & Write	<b>Minimum</b>	0.0 Sec
<b>Units</b>	0.1 Second	<b>Maximum</b>	3600.0 Sec

**[Decel Time 1]**

This parameter is the factory default parameter for determining the time it will take the drive to ramp from **[Maximum Frequency]** to 0 Hz. The rate is linear unless **[S Curve]** is "Enabled" or **[Stop Select]** is set to "S-Curve." It applies to any decrease in command frequency. The **[Decel Time 2]** parameter can be selected in place of this parameter. (See Chart on Page 5-30).

<b>Parameter #</b>	8	<b>Factory Default</b>	10.0 Sec
<b>Parameter Type</b>	Read & Write	<b>Minimum</b>	0.0 Sec
<b>Units</b>	0.1 Second	<b>Maximum</b>	3600.0 Sec

**Figure 5.1 Accel/Decel Time**

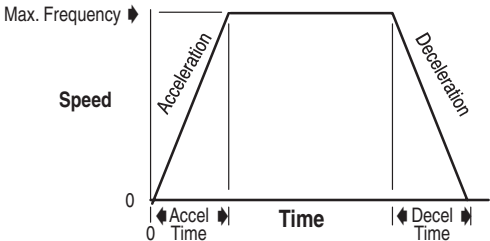

**Setup Group** (continued)

<p><b>[Base Frequency]</b></p> <p>This value should be set to the motor nameplate Rated Frequency.</p>	<p><b>Parameter #</b> 17</p> <p><b>Parameter Type</b> Read &amp; Write</p> <p><b>Units</b> 1 Hz</p>	<p><b>Factory Default</b> 60 Hz</p> <p><b>Minimum</b> 40 Hz</p> <p><b>Maximum</b> 400 Hz</p>
<p><b>[Base Voltage]</b></p> <p>This value should be set to the motor nameplate Rated Voltage.</p>	<p><b>Parameter #</b> 18</p> <p><b>Parameter Type</b> Read &amp; Write</p> <p><b>Units</b> 1 Volt</p>	<p><b>Factory Default</b> Max. Drive Rated Volts</p> <p><b>Minimum</b> 25% of Max. Drive Rated Volts</p> <p><b>Maximum</b> 100% of Max. Drive Rated Volts</p>
<p><b>[Maximum Voltage]</b></p> <p>This parameter sets the highest voltage the drive will output.</p>	<p><b>Parameter #</b> 20</p> <p><b>Parameter Type</b> Read &amp; Write</p> <p><b>Units</b> 1 Volt</p>	<p><b>Factory Default</b> Max. Drive Rated Volts</p> <p><b>Minimum</b> 25% of Max. Drive Rated Voltage</p> <p><b>Maximum</b> 110% of Max. Drive Rated Volts</p>
<p><b>[Minimum Freq]</b></p> <p>This parameter sets the lowest frequency the drive will output.</p> <p><b>Important:</b> All analog inputs to the drive (4-20mA, 0-10V, Remote Pot) are scaled for the range <b>[Minimum Freq]</b> to <b>[Maximum Freq]</b>.</p>	<p><b>Parameter #</b> 16</p> <p><b>Parameter Type</b> Read &amp; Write</p> <p><b>Units</b> 1 Hz</p>	<p><b>Factory Default</b> 0 Hz</p> <p><b>Minimum</b> 0 Hz</p> <p><b>Maximum</b> 120 Hz</p> <p><b>Important:</b> This parameter can not be programmed while the drive is running.</p>

**Setup Group** (continued)

<p><b>[Maximum Freq]</b></p> <p>This parameter sets the highest frequency the drive will output. <b>Important:</b> All analog inputs to the drive (4-20mA, 0-10V, Remote Pot) are scaled for the range <b>[Minimum Freq]</b> to <b>[Maximum Freq]</b>. Max hertz may be set to less than base hertz.</p>	<p><b>Parameter #</b> 19  <b>Parameter Type</b> Read &amp; Write  <b>Units</b> 1 Hz</p>	<p><b>Factory Default</b> 60 Hz  <b>Minimum</b> 40 Hz  <b>Maximum</b> 400 Hz</p>	<p><b>Important:</b> This parameter can not be programmed while the drive is running.</p>
<p><b>[Stop Select]</b></p> <p>This parameter selects the stopping mode when the drive receives a valid stop command.</p>	<p><b>Parameter #</b> 10  <b>Parameter Type</b> Read &amp; Write  <b>Units</b> Text</p>	<p><b>Factory Default</b> "Ramp"  <b>Settings</b> "Coast"  "Ramp"  "DC Brake"  "S-Curve"</p>	<p><i>Causes the Drive to Turn Off Immediately</i>  <i>Drive Decelerates to 0 Hz, Then Turns Off – Requires a Value In [Decel Time 1] or [Decel Time 2]</i>  <i>Injects DC Braking Voltage Into the Motor – Requires a Value in Both [Decel Hold Time] &amp; [Decel Hold Level].</i>  <i>Drive ramps to stop using 'fixed S-Curve' profile. Stop time is twice the selected decel time.</i></p>
<p><b>[Current Limit]</b></p> <p>This parameter sets the maximum drive output current that is allowed before current limiting occurs. <b>Important:</b> If a value is programmed into the <b>[Sec Curr Limit]</b> parameter then that value will be the active current limit value at speeds above 1.5 times <b>[Base Frequency]</b>. See Fig. 5.5. <b>[Output 1 Config]</b> and <b>[Output 2 Config]</b> can be set to "alarm" to indicate an overload condition exists.</p>	<p><b>Parameter #</b> 36  <b>Parameter Type</b> Read &amp; Write  <b>Units</b> 1 %</p>	<p><b>Factory Default</b> 150 % of Drive Rated Current ①  <b>Minimum</b> 20 % of Drive Rated Current ①  <b>Maximum</b> 150% of Drive Rated Current ①</p>	<p><b>Important:</b> See <b>[Cur Lim Trip En]</b> on page 5-40.</p>

① The Drive Rated Output Current is based on three phase input ratings. See page 5-13 for instructions for **Single Phase Input Ratings**.

**Setup Group** (continued)

<b>[Overload Mode]</b>	<b>Parameter #</b>	37	<b>Factory Default</b>	"No Derating"	
	<b>Parameter Type</b>	Read & Write			
	<b>Units</b>	Text	<b>Settings</b>	"No Derating"	10:1 Speed Range – No Derating Refer to Figure 5.2
				"Min Derate"	4:1 Speed Range – Derate below 25% of Base Speed. Refer to Figure 5.3
				"Max Derate"	2:1 Speed Range – Derate below 50% of Base Speed. Refer to Figure 5.4

This parameter selects the derating factor for the I<sup>2</sup>t electronic overload function. Designed to meet NEC Article 430 and UL (file E59272) equivalent requirements. Additional overload devices do not need to be installed.

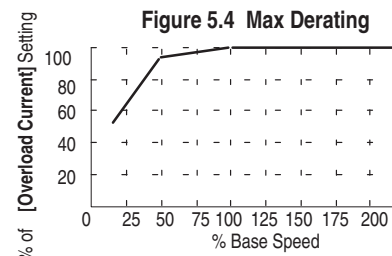
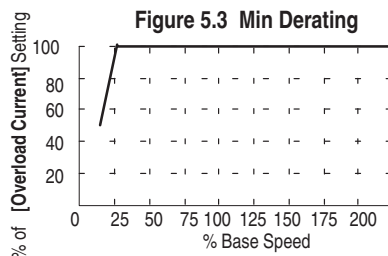
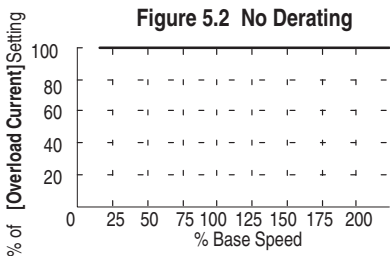

<b>[Overload Current]</b>	<b>Parameter #</b>	38	<b>Factory Default</b>	115% of Drive Rated Current	<i>Displayed in Amps</i>
	<b>Parameter Type</b>	Read & Write	<b>Minimum</b>	20% of Drive Rated Current	<i>Displayed in Amps</i>
	<b>Units</b>	0.1 Amps	<b>Maximum</b>	115% of Drive Rated Current	<i>Displayed in Amps</i>

This value should be set to the motor nameplate Full Load Amps (F.L.A.).

Setup Group (continued)

[Sec Curr Limit]

When this parameter is set to zero, the [Current Limit] setting is used throughout the frequency range. When set to a value other than zero, the [Current Limit] value will be active up to the [Base Frequency] setting, then tapers down between [Base Frequency] and 1.5 times [Base Frequency]. At frequencies above 1.5 times [Base Frequency], the [Sec Curr Limit] setting is the active current limit value.

Parameter #	141	Factory Default	0% of Drive Rated Current ①
Parameter Type	Read & Write	Minimum	0% of Drive Rated Current ①
Units	1%	Maximum	150% of Drive Rated Current ①

Figure 5.5 Current Limit Setting

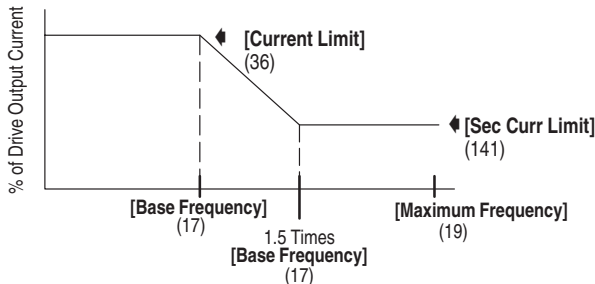

Single Phase Input Ratings

The [Current Limit], [Overload Current] and [Sec Curr Limit] parameters are set based on the drive rated output current for three phase input ratings. When setting these parameters for single phase input ratings, use the following formula to determine the proper parameter setting:

$$\frac{1\text{-Phase Output Current } \textcircled{2} \times \text{Percent (0 to 150\%)}}{\text{Three-Phase Output Current } \textcircled{2}} = \text{Parameter Setting in Percent}$$

① The Drive Rated Output Current is based on three phase input ratings. See Single Phase Input Ratings instructions.

② See Table 1.A on page 1-6.

**Setup Group** *(continued)***[Adaptive I Lim]**

When ENABLED (default), this parameter allows tripless commanded accelerations into medium to high inertia conditions and delivers maximum performance when drive load conditions change with time. For most circumstances this is the correct selection.

When DISABLED, this parameter allows quicker acceleration times from stopped to commanded speed with low system inertia.

<b>Parameter #</b>	149	<b>Factory Default</b>	"Enabled"
<b>Parameter Type</b>	Read & Write		
<b>Units</b>	Text	<b>Settings</b>	"Enabled" "Disabled"

**Advanced Setup**

This group contains parameters that are required to setup advanced functions of the drive such as custom Volts per Hertz settings and dynamic braking.

<p><b>[Minimum Freq]</b></p> <p>This parameter sets the lowest frequency the drive will output.</p> <p><b>Important:</b> All analog inputs to the drive (4-20mA, 0-10V, Remote Pot) are scaled for the range <b>[Minimum Freq]</b> to <b>[Maximum Freq]</b>.</p>	<table border="1"> <tr> <td><b>Parameter #</b></td> <td>16</td> <td><b>Factory Default</b></td> <td>0 Hz</td> </tr> <tr> <td><b>Parameter Type</b></td> <td>Read &amp; Write</td> <td><b>Minimum</b></td> <td>0 Hz</td> </tr> <tr> <td><b>Units</b></td> <td>1 Hz</td> <td><b>Maximum</b></td> <td>120 Hz</td> </tr> </table> <p><b>Important:</b> This parameter can not be programmed while the drive is running.</p>	<b>Parameter #</b>	16	<b>Factory Default</b>	0 Hz	<b>Parameter Type</b>	Read & Write	<b>Minimum</b>	0 Hz	<b>Units</b>	1 Hz	<b>Maximum</b>	120 Hz
<b>Parameter #</b>	16	<b>Factory Default</b>	0 Hz										
<b>Parameter Type</b>	Read & Write	<b>Minimum</b>	0 Hz										
<b>Units</b>	1 Hz	<b>Maximum</b>	120 Hz										

<p><b>[Maximum Freq]</b></p> <p>This parameter sets the highest frequency the drive will output.</p> <p><b>Important:</b> All analog inputs to the drive (4-20mA, 0-10V, Remote Pot) are scaled for the range <b>[Minimum Freq]</b> to <b>[Maximum Freq]</b>.</p>	<table border="1"> <tr> <td><b>Parameter #</b></td> <td>19</td> <td><b>Factory Default</b></td> <td>60 Hz</td> </tr> <tr> <td><b>Parameter Type</b></td> <td>Read &amp; Write</td> <td><b>Minimum</b></td> <td>40 Hz</td> </tr> <tr> <td><b>Units</b></td> <td>1 Hz</td> <td><b>Maximum</b></td> <td>400 Hz</td> </tr> </table> <p><b>Important:</b> This parameter can not be programmed while the drive is running.</p>	<b>Parameter #</b>	19	<b>Factory Default</b>	60 Hz	<b>Parameter Type</b>	Read & Write	<b>Minimum</b>	40 Hz	<b>Units</b>	1 Hz	<b>Maximum</b>	400 Hz
<b>Parameter #</b>	19	<b>Factory Default</b>	60 Hz										
<b>Parameter Type</b>	Read & Write	<b>Minimum</b>	40 Hz										
<b>Units</b>	1 Hz	<b>Maximum</b>	400 Hz										

<p><b>[Base Frequency]</b></p> <p>This value should be set to the motor nameplate Rated Frequency.</p>	<table border="1"> <tr> <td><b>Parameter #</b></td> <td>17</td> <td><b>Factory Default</b></td> <td>60 Hz</td> </tr> <tr> <td><b>Parameter Type</b></td> <td>Read &amp; Write</td> <td><b>Minimum</b></td> <td>40 Hz</td> </tr> <tr> <td><b>Units</b></td> <td>1 Hz</td> <td><b>Maximum</b></td> <td>400 Hz</td> </tr> </table>	<b>Parameter #</b>	17	<b>Factory Default</b>	60 Hz	<b>Parameter Type</b>	Read & Write	<b>Minimum</b>	40 Hz	<b>Units</b>	1 Hz	<b>Maximum</b>	400 Hz
<b>Parameter #</b>	17	<b>Factory Default</b>	60 Hz										
<b>Parameter Type</b>	Read & Write	<b>Minimum</b>	40 Hz										
<b>Units</b>	1 Hz	<b>Maximum</b>	400 Hz										

**Advanced Setup Group** (continued)**[Base Voltage]**

This value should be set to the motor nameplate Rated Voltage.

<b>Parameter #</b>	18	<b>Factory Default</b>	Max. Drive Rated Volts
<b>Parameter Type</b>	Read & Write	<b>Minimum</b>	25% of Max. Drive Rated Volts
<b>Units</b>	1 Volt	<b>Maximum</b>	100% of Max. Drive Rated Volts

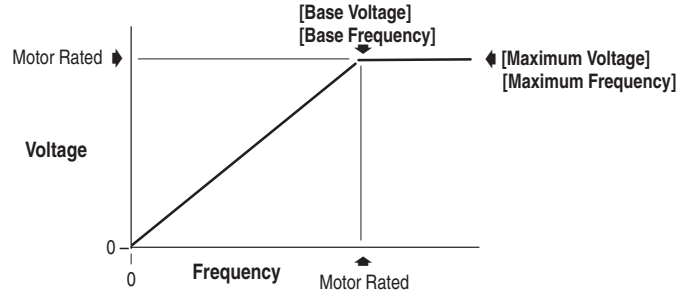
**Figure 5.6 Standard Volts-per-Hz Pattern****[Break Frequency]**

This parameter sets a midpoint frequency on a custom Volts-per-Hz curve. Combined with **[Break Voltage]**, this value determines the Volts-per-Hz ratio between 0 and **[Break Frequency]**.

**Important:** **[DC Boost Select]** must be set to "Break Point" for this parameter to be active.

<b>Parameter #</b>	49	<b>Factory Default</b>	30 Hz
<b>Parameter Type</b>	Read & Write	<b>Minimum</b>	0 Hz
<b>Units</b>	1 Hz	<b>Maximum</b>	120 Hz

**Advanced Setup Group** (continued)

<p><b>[Break Voltage]</b></p> <p>Sets the voltage the drive will output at <b>[Break Frequency]</b>. Combined with <b>[Break Frequency]</b>, this value determines the Volts-per-Hz ratio between 0 and <b>[Break Frequency]</b>.</p> <p><b>Important:</b> <b>[DC Boost Select]</b> must be set to “Break Point” to activate this parameter.</p>	<p><b>Parameter #</b> 50</p>	<p><b>Factory Default</b> 115V for 230V Drive 230V for 460V Drive</p>
	<p><b>Parameter Type</b> Read &amp; Write</p>	<p><b>Minimum</b> 0 Volts</p>
	<p><b>Units</b> 1 Volt</p>	<p><b>Maximum</b> 50% of Max. Drive Rated Volts</p>

<p><b>[Maximum Voltage]</b></p> <p>Sets the highest voltage the drive will output.</p> <p><b>Important:</b> <b>[Maximum Voltage]</b> does not have to be set greater than <b>[Base Voltage]</b>, but the maximum drive output is limited to <b>[Maximum Voltage]</b>.</p>	<p><b>Parameter #</b> 20</p>	<p><b>Factory Default</b> Max. Drive Rated Volts</p>
	<p><b>Parameter Type</b> Read &amp; Write</p>	<p><b>Minimum</b> 25% of Max. Drive Rated Volts</p>
	<p><b>Units</b> 1 Volt</p>	<p><b>Maximum</b> 110% of Max. Drive Rated Volts</p>

**Figure 5.7 Custom Volts-per-Hz Pattern**

This pattern is active only when **[DC Boost Select]** is set to “Break Point.”

The following guidelines should be followed when setting up a custom Volts-per-Hz curve:

1. **[Base Voltage]** must be greater than **[Start Boost]**.
2. If **[DC Boost Select]** is set to “Break Point” then:
  - [Base Voltage]** must be greater than **[Break Voltage]** and **[Break Voltage]** must be greater than **[Start Boost]**.

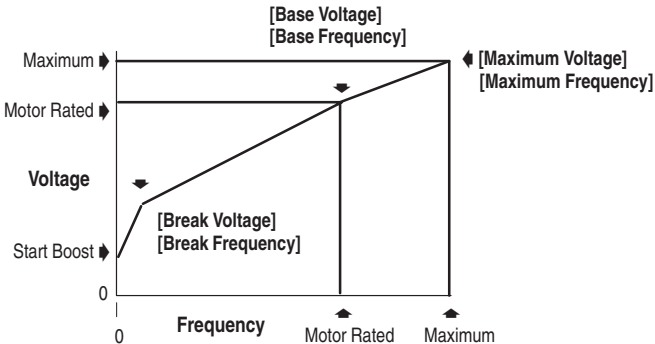

**Advanced Setup Group** (continued)**[DC Boost Select]**

This parameter sets the level of DC boost at low frequencies. It also selects special Volts-per-Hz patterns.

Parameter #	9	Factory Default	"Break Point"
Parameter Type	Read & Write	Settings	"No Boost" <i>See Figure 5.8</i> "6 Volts" <i>See Figure 5.8</i> "12 Volts" <i>See Figure 5.8</i> "18 Volts" <i>See Figure 5.8</i> "24 Volts" <i>See Figure 5.8</i> "30 Volts" <i>See Figure 5.8</i> "36 Volts" <i>See Figure 5.8</i> "42 Volts" <i>See Figure 5.8</i> "48 Volts" <i>See Figure 5.8</i> "Break Point" <i>See Figure 5.7</i> "Run Boost" <i>See Figure 5.10</i> "Fan Sel #1" <i>See Figure 5.9</i> "Fan Sel #2" <i>See Figure 5.9</i>
Units	Text		

**Figure 5.8 Standard Boost Volts-per-Hz Pattern**

Active when [DC Boost Select] is set to "No Boost" or "6 Volts" through "48 Volts."

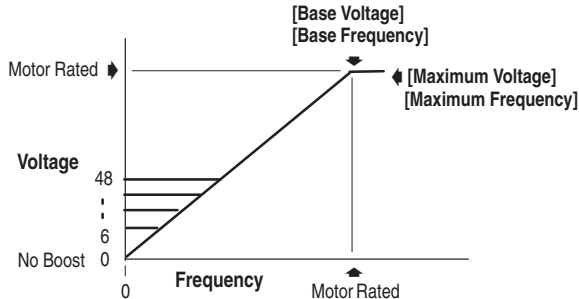
**Figure 5.9 Fan/Pump Volts-per-Hz Pattern**

These patterns are active only when [DC Boost Select] is set to "Fan Sel #1" or "Fan Sel #2."

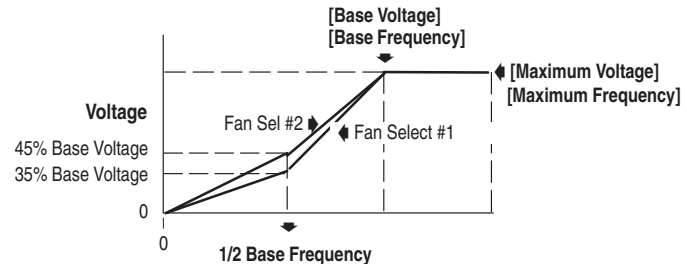

**Advanced Setup Group** (continued)

<b>[Start Boost]</b>	<b>Parameter #</b>	48	<b>Factory Default</b>	See Table		0.37 kW (0.5 HP)	0.55 kW (0.75 HP)	0.75 kW (1 HP)	1.5 kW (2 HP)	2.2 kW (3 HP)	4.0 kW (5 HP)
	<b>Parameter Type</b>	Read & Write	<b>Minimum</b>	0 Volts	230V	3 Volts	3 Volts	3 Volts	3 Volts	3 Volts	N/A
	<b>Units</b>	1 Volt	<b>Maximum</b>	25% of Max. Drive Rated Volts	460V	12 Volts	12 Volts	12 Volts	9 Volts	6 Volts	6 Volts

This parameter sets the DC boost level for acceleration when **[DC Boost Select]** is set to "Run Boost" or "Break Point."

**Figure 5.10 Start/Run Boost**

Active when **[DC Boost Select]** is set to "Run Boost"

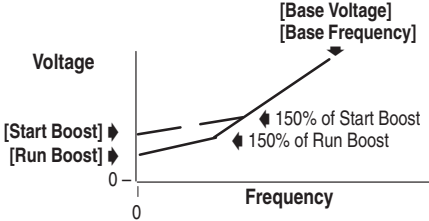

<b>[Run Boost]</b>	<b>Parameter #</b>	83	<b>Factory Default</b>	0 Volts
	<b>Parameter Type</b>	Read & Write	<b>Minimum</b>	0 Volts
	<b>Units</b>	1 Volt	<b>Maximum</b>	25% of Max. Drive Rated Volts

This parameter sets the DC boost level for constant speed level when **[DC Boost Select]** is set to "Run Boost." **[Run Boost]** must be set at a value less than **[Start Boost]**.

**Advanced Setup Group** (continued)**[PWM Frequency]**

This parameter sets the carrier frequency for the PWM output waveform.

**Important:** Output Current derating applies above 4kHz. See Fig. 5-11.

**Important:** Changing PWM carrier frequency may result in changes in Start-up and Holding current if start boost and DC Holding voltages are in effect. These parameters should be checked if the carrier frequency is changed and reprogrammed if needed.

<b>Parameter #</b>	45	<b>Factory Default</b>	4.0 kHz
<b>Parameter Type</b>	Read & Write	<b>Minimum</b>	2.0 kHz
<b>Units</b>	0.1 kHz	<b>Maximum</b>	8.0 kHz

**Figure 5.11 PWM Frequency Derating**

**Important:** Ignoring derating guidelines can cause reduced drive performance.

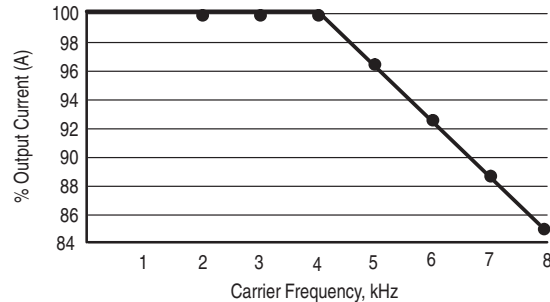

**Advanced Setup Group** (continued)

<p><b>[Analog Invert]</b></p> <p>This parameter enables the inverting function for the 0-10 Volt and 4-20mA analog input signal at TB2.</p>	<p><b>Parameter #</b> 84</p> <p><b>Parameter Type</b> Read &amp; Write</p> <p><b>Units</b> Text</p>	<p><b>Factory Default</b> "Disabled"</p> <p><b>Settings</b> "Enabled" "Disabled"</p>	<p>Maximum Input Commands <b>[Minimum Freq]</b></p> <p>Minimum Input Commands <b>[Maximum Freq]</b></p> <p>Maximum Input Commands <b>[Maximum Freq]</b></p> <p>Minimum Input Commands <b>[Minimum Freq]</b></p>
---	---	--	---

**Figure 5.12 Analog Invert**

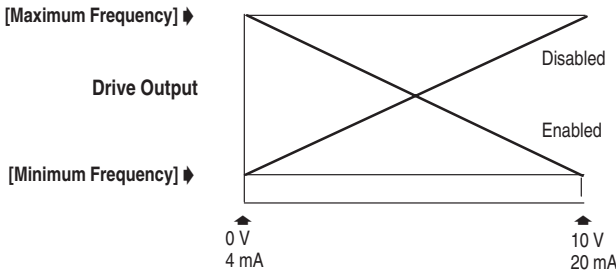

<p><b>[4-20mA Loss Sel]</b></p> <p>This parameter selects the drives reaction to a loss of a 4-20mA signal when the active <b>[Frequency Source]</b> is 4-20mA. <b>Important:</b> The drive output contacts can be used to issue an alarm signal by setting <b>[Output 1 Config]</b> or <b>[Output 2 Config]</b> to "alarm". <b>Important:</b> Loss of signal is defined as a signal &lt; 3.5 mA or a signal &gt; 20.5 mA.</p>	<p><b>Parameter #</b> 81</p> <p><b>Parameter Type</b> Read &amp; Write</p> <p><b>Units</b> Text</p>	<p><b>Factory Default</b> "Stop/Fault"</p> <p><b>Settings</b> "Stop/Fault" "Hold/Alarm" "Max/Alarm" "Pre1/Alarm" "Min/Alarm"</p>	<p>Drive Stops and Issues "Hz Err Fault" (F29)</p> <p>Drive Maintains Last Output Freq and sets an Alarm bit</p> <p>Drive Outputs <b>[Maximum Freq]</b> and sets Alarm bit</p> <p>Drive Outputs <b>[Preset Freq 1]</b> and sets an Alarm bit</p> <p>Drive Outputs <b>[Minimum Freq]</b> and sets an Alarm bit</p>
--	---	--	---

**Advanced Setup Group** (continued)

<p><b>[Stop Select]</b></p> <p>This parameter selects the stopping mode when the drive receives a valid stop command.</p>	<p><b>Parameter #</b> 10</p> <p><b>Parameter Type</b> Read &amp; Write</p> <p><b>Units</b> Text</p> <p><b>Factory Default</b> "Ramp"</p> <p><b>Settings</b></p> <p>"Coast" <i>Causes the Drive to Turn Off Immediately</i></p> <p>"Ramp" <i>Drive Decelerates to 0 Hz, Then Turns Off – Requires a Value In [Decel Time 1] or [Decel Time 2]</i></p> <p>"DC Brake" <i>Injects DC Braking Voltage Into the Motor – Requires a Value in Both [Decel Hold Time] &amp; [Decel Hold Level].</i></p> <p>"S-Curve" <i>Drive ramps to stop using a fixed "S-Curve" profile. Stop time is twice the selected decel time.</i></p>
<p><b>[DC Hold Time]</b></p> <p>This value sets the amount of time that the <b>[DC Hold Level]</b> voltage will be applied to the motor when the stop mode is set to either "DC Brake" or "Ramp." When in "Coast" mode and the drive is stopped and restarted within the <b>[DC Hold Time]</b> setting, the speed will resume at the output frequency prior to the stop command.</p>	<p><b>Parameter #</b> 12</p> <p><b>Parameter Type</b> Read &amp; Write</p> <p><b>Units</b> 0.1 Seconds</p> <p><b>Factory Default</b> 0.0 Sec</p> <p><b>Minimum</b> 0.0 Sec</p> <p><b>Maximum</b> 150 Sec</p>

Figure 5.13 Ramp

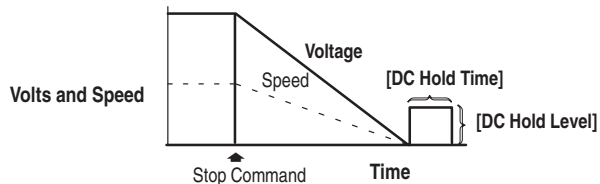
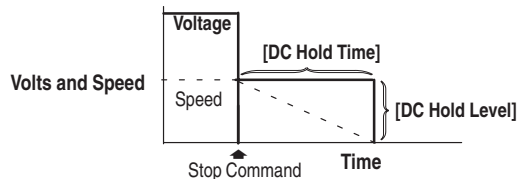

Figure 5.14 DC Brake



**Advanced Setup Group** (continued)

<p><b>[DC Hold Volts]</b></p> <p>This parameter value sets the DC voltage applied to the motor during braking when the <b>[Stop Select]</b> is set to either “DC Brake” or “Ramp”.</p> <p><b>Important:</b> When setting this parameter, begin at a low voltage and continue increasing until sufficient holding torque is achieved and the drive output current rating is not exceeded.</p>	<table border="0"> <tr> <td><b>Parameter #</b></td> <td>13</td> <td><b>Factory Default</b></td> <td>0 Volts</td> </tr> <tr> <td><b>Parameter Type</b></td> <td>Read &amp; Write</td> <td><b>Minimum</b></td> <td>0 Volts</td> </tr> <tr> <td><b>Units</b></td> <td>1 Volt</td> <td><b>Maximum</b></td> <td>25% of Max. Drive Rated Volts</td> </tr> </table>	<b>Parameter #</b>	13	<b>Factory Default</b>	0 Volts	<b>Parameter Type</b>	Read & Write	<b>Minimum</b>	0 Volts	<b>Units</b>	1 Volt	<b>Maximum</b>	25% of Max. Drive Rated Volts
<b>Parameter #</b>	13	<b>Factory Default</b>	0 Volts										
<b>Parameter Type</b>	Read & Write	<b>Minimum</b>	0 Volts										
<b>Units</b>	1 Volt	<b>Maximum</b>	25% of Max. Drive Rated Volts										
<p><b>[DB Enable]</b></p> <p>This parameter enables the use of external dynamic brake resistors by disabling the internal ramp regulation.</p> <p><b>Important:</b> Dynamic braking is not available for 0.37 - 0.75 kW (0.5 - 1HP) units rated 230 Volt.</p>	<table border="0"> <tr> <td><b>Parameter #</b></td> <td>11</td> <td><b>Factory Default</b></td> <td>“Disabled”</td> </tr> <tr> <td><b>Parameter Type</b></td> <td>Read &amp; Write</td> <td><b>Settings</b></td> <td>“Enabled” <i>Permits dynamic brake operation</i></td> </tr> <tr> <td><b>Units</b></td> <td>Text</td> <td></td> <td>“Disabled” <i>Permits Ramp Regulation</i></td> </tr> </table>	<b>Parameter #</b>	11	<b>Factory Default</b>	“Disabled”	<b>Parameter Type</b>	Read & Write	<b>Settings</b>	“Enabled” <i>Permits dynamic brake operation</i>	<b>Units</b>	Text		“Disabled” <i>Permits Ramp Regulation</i>
<b>Parameter #</b>	11	<b>Factory Default</b>	“Disabled”										
<b>Parameter Type</b>	Read & Write	<b>Settings</b>	“Enabled” <i>Permits dynamic brake operation</i>										
<b>Units</b>	Text		“Disabled” <i>Permits Ramp Regulation</i>										
<p><b>[Motor Type]</b></p> <p>Factory default for this parameter is an induction motor. Changing this parameter to “Sync PM” causes <b>[Compensation]</b> and <b>[Rated Slip]</b> to be internally disabled.</p>	<table border="0"> <tr> <td><b>Parameter #</b></td> <td>41</td> <td><b>Factory Default</b></td> <td>“Induc/Reluc”</td> </tr> <tr> <td><b>Parameter Type</b></td> <td>Read &amp; Write</td> <td><b>Settings</b></td> <td>“Induc/Reluc” <i>Requires No Additional Setting for use with induction/reluctance rated motors</i></td> </tr> <tr> <td><b>Units</b></td> <td>Text</td> <td></td> <td>“Sync PM” <i>Requires [Stop Select] to be set to a selection other than “DC Brake” when used with Synchronous Permanent Magnet Motors</i></td> </tr> </table>	<b>Parameter #</b>	41	<b>Factory Default</b>	“Induc/Reluc”	<b>Parameter Type</b>	Read & Write	<b>Settings</b>	“Induc/Reluc” <i>Requires No Additional Setting for use with induction/reluctance rated motors</i>	<b>Units</b>	Text		“Sync PM” <i>Requires [Stop Select] to be set to a selection other than “DC Brake” when used with Synchronous Permanent Magnet Motors</i>
<b>Parameter #</b>	41	<b>Factory Default</b>	“Induc/Reluc”										
<b>Parameter Type</b>	Read & Write	<b>Settings</b>	“Induc/Reluc” <i>Requires No Additional Setting for use with induction/reluctance rated motors</i>										
<b>Units</b>	Text		“Sync PM” <i>Requires [Stop Select] to be set to a selection other than “DC Brake” when used with Synchronous Permanent Magnet Motors</i>										

**Advanced Setup Group** *(continued)***[Compensation]**

Some drive/motor combinations have inherent instabilities which are exhibited as nonsinusoidal current feedback. The compensation when enabled will correct this condition. This compensation is active from 1.1 Hz up to a maximum of 120 Hz. This compensation is turned off when **[Motor Type]** = "Sync PM."

<b>Parameter #</b>	52	<b>Factory Default</b>	"Comp"
<b>Parameter Type</b>	Read & Write		
<b>Units</b>	Text	<b>Settings</b>	"No Comp"      Compensation Disabled "Comp"      Compensation Enabled

**Frequency Set**

This group of parameters allows the user to program the frequency source, frequency settings, accel/decel times and skip frequencies of the drive.

**[Freq Select 1]**

This parameter is the factory default parameter for selecting the frequency source that will supply the [Freq Command] to the drive. [Freq Select 2] or [Preset Freq 1-7] can be selected in place of this parameter with proper terminal block inputs. Refer to charts on Pages 5-29 and 5-30.

**Important:** If an adapter that is not connected is selected as the active frequency source, the drive will fault on "Hz Sel Fault" (F30).

<b>Parameter #</b>	5	<b>Factory Default</b>	"Adapter 1"	
<b>Parameter Type</b>	Read & Write			
<b>Units</b>	Text	<b>Settings</b>	"Remote Pot"	"Preset 1"
			"0-10 Volt"	"Preset 2"
			"4-20 mA"	"Preset 3"
			"MOP"	"Preset 4"
			"Adapter 1"	"Preset 5"
			"Adapter 2"	"Preset 6"
			"Adapter 3"	"Preset 7"
			"Adapter 4"	
			"Adapter 5"	
			"Adapter 6"	

**[Freq Select 2]**

This parameter controls which of the frequency sources is currently supplying the [Freq Command] to the drive unless [Freq Select 1] or [Preset Freq 1-7] are selected with proper terminal block inputs. Refer to charts on Pages 5-29 and 5-30.

**Important:** If an adapter that is not connected is selected as the active frequency source, the drive will fault on "Hz Sel Fault" (F30).

<b>Parameter #</b>	6	<b>Factory Default</b>	"Remote Pot"	
<b>Parameter Type</b>	Read & Write			
<b>Units</b>	Text	<b>Settings</b>	"Remote Pot"	"Preset 1"
			"0-10 Volt"	"Preset 2"
			"4-20 mA"	"Preset 3"
			"MOP"	"Preset 4"
			"Adapter 1"	"Preset 5"
			"Adapter 2"	"Preset 6"
			"Adapter 3"	"Preset 7"
			"Adapter 4"	
			"Adapter 5"	
			"Adapter 6"	

**Frequency Set Group** (continued)

<b>[Jog Frequency]</b>	<b>Parameter #</b> 24 <b>Parameter Type</b> Read & Write <b>Units</b> 0.1 Hz	<b>Factory Default</b> 10.0 Hz <b>Minimum</b> 0.0 Hz <b>Maximum</b> 400.0 Hz
<p>This parameter sets the frequency the drive will output when it receives a jog command.</p>		
<b>[Prst/2nd Accel]</b>	<b>Parameter #</b> 26 <b>Parameter Type</b> Read & Write <b>Units</b> Text	<b>Factory Default</b> "Preset" <b>Settings</b> "Preset" "2nd Accel"
<p>This parameter, along with the <b>[Upper Presets]</b> parameter, determines which frequency source and Accel/Decel parameters will be selected using the optional inputs SW1, SW2 and SW3. Refer to charts on Pages 5-29 and 5-30.</p>		
<b>[Upper Presets]</b>	<b>Parameter #</b> 72 <b>Parameter Type</b> Read & Write <b>Units</b> Text	<b>Factory Default</b> "Disabled" <b>Settings</b> "Enabled" "Disabled"
<p>This parameter along with the <b>[Prst/2nd Accel]</b> parameter determines which frequency source and Accel/Decel parameters will be selected using the optional inputs SW1, SW2 and SW3. Refer to charts on Pages 5-29 and 5-30.</p>		
<b>[Accel Time 2]</b>	<b>Parameter #</b> 30 <b>Parameter Type</b> Read & Write <b>Units</b> 0.1 Second	<b>Factory Default</b> 5.0 Sec <b>Minimum</b> 0.0 Sec <b>Maximum</b> 3600.0 Sec
<p>This value determines the time it will take the drive to ramp from 0 Hz to <b>[Maximum Frequency]</b>. The rate is linear unless <b>[S Curve]</b> is "Enabled." It applies to any increase in command frequency unless <b>[Accel Time 1]</b> is selected. Refer to charts on Pages 5-29 and 5-30.</p>		

**Frequency Set Group** (continued)

<p><b>[Decel Time 2]</b></p> <p>This value determines the time it will take the drive to ramp from <b>[Maximum Freq]</b> to 0 Hz. The rate is linear unless <b>[S Curve]</b> is “Enabled” or <b>[Stop Select]</b> is set to “S-Curve.” It applies to any decrease in command frequency unless <b>[Decel Time 1]</b> is selected. Refer to charts on Pages 5-29 and 5-30.</p>	<p><b>Parameter #</b> 31</p>	<p><b>Factory Default</b> 5.0 Sec</p>																									
	<p><b>Parameter Type</b> Read &amp; Write</p> <p><b>Units</b> 0.1 Second</p>	<p><b>Minimum</b> 0.0 Sec</p> <p><b>Maximum</b> 3600.0 Sec</p>																									
<p><b>[Preset Freq 1-7]</b></p> <p>These values set the frequencies that the drive will output when selected. Refer to charts on Pages 5-29 and 5-30.</p>	<p><b>Parameter #</b> See Table</p> <p><b>Parameter Type</b> Read &amp; Write</p> <p><b>Units</b> 0.1 Hz</p>	<p><b>Factory Default</b> See Table</p> <p><b>Minimum</b> 0.0 Hz</p> <p><b>Maximum</b> 400.0 Hz</p>	<table border="1"> <thead> <tr> <th>Parameter</th> <th>No.</th> <th>Default</th> </tr> </thead> <tbody> <tr> <td>[Preset Freq 1]</td> <td>27</td> <td>10.0 Hz</td> </tr> <tr> <td>[Preset Freq 2]</td> <td>28</td> <td>20.0 Hz</td> </tr> <tr> <td>[Preset Freq 3]</td> <td>29</td> <td>30.0 Hz</td> </tr> <tr> <td>[Preset Freq 4]</td> <td>73</td> <td>40.0 Hz</td> </tr> <tr> <td>[Preset Freq 5]</td> <td>74</td> <td>50.0 Hz</td> </tr> <tr> <td>[Preset Freq 6]</td> <td>75</td> <td>60.0 Hz</td> </tr> <tr> <td>[Preset Freq 7]</td> <td>76</td> <td>0.0 Hz</td> </tr> </tbody> </table>	Parameter	No.	Default	[Preset Freq 1]	27	10.0 Hz	[Preset Freq 2]	28	20.0 Hz	[Preset Freq 3]	29	30.0 Hz	[Preset Freq 4]	73	40.0 Hz	[Preset Freq 5]	74	50.0 Hz	[Preset Freq 6]	75	60.0 Hz	[Preset Freq 7]	76	0.0 Hz
	Parameter	No.	Default																								
	[Preset Freq 1]	27	10.0 Hz																								
	[Preset Freq 2]	28	20.0 Hz																								
	[Preset Freq 3]	29	30.0 Hz																								
	[Preset Freq 4]	73	40.0 Hz																								
	[Preset Freq 5]	74	50.0 Hz																								
	[Preset Freq 6]	75	60.0 Hz																								
[Preset Freq 7]	76	0.0 Hz																									
<p><b>[Skip Freq 1-3]</b></p> <p>These values, in conjunction with <b>[Skip Freq Band]</b>, create a range of frequencies at which the drive will not operate continuously.</p>	<p><b>Parameter #</b> 32-34</p>	<p><b>Factory Default</b> 400 Hz</p>																									
	<p><b>Parameter Type</b> Read &amp; Write</p> <p><b>Units</b> 1 Hz</p>	<p><b>Minimum</b> 0 Hz</p> <p><b>Maximum</b> 400 Hz</p>																									

**Programming the drive for Frequency Source and Accel/Decel Control**

Use Table 5.A through Table 5.C to determine which frequency source and Accel/Decel Time are suitable to your application. Switch or contact inputs at terminal TB2 are used to select functionality based on how you program parameters (26), (72), and (21).

## Frequency Set Group *(continued)*

### [Skip Freq Band]

This parameter determines the band width around a [Skip Frequency]. The band width is  $2 \times [\text{Skip Freq Band}] - 1/2$  the band above and  $1/2$  the band below the [Skip Frequency] setting. "0" Disables All Skip Frequencies.

Parameter #	35	Factory Default	0 Hz
Parameter Type	Read & Write	Minimum	0 Hz
Units	1 Hz	Maximum	15 Hz

Figure 5.15 Skip Frequency Band

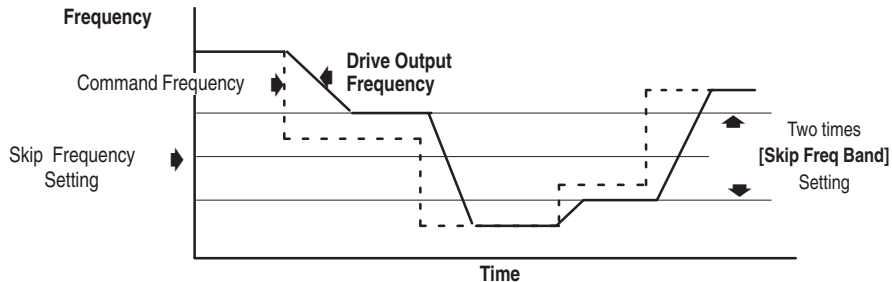

### [MOP Increment]

The MOP function is a digital solid-state circuit that produces the same effect as rotating a speed reference potentiometer with a small DC motor. This permits local (HIM) or remote (TB2) control of the command frequency. This parameter sets the rate of increase or decrease to the [MOP Hertz] command frequency for each input to the MOP Increment or MOP Decrement terminals of TB2. (Requires the proper [Input Mode] selection or serial communications.)

Parameter #	22	Factory Default	1.00 Hz/Sec
Parameter Type	Read & Write	Minimum	0.00 Hz/Sec
Units	1 Hz/Sec	Maximum	255 Hz/Sec

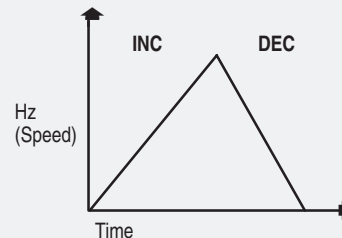

## Frequency Set Group (continued)

Table 5.A Frequency Source Selection

Parameter Settings		Frequency Source ①										Accel/Decel				Control Terminal Block		
Preset/ 2nd Accel(26)	Upper Presets (72)	Freq Select 1 (5)	Freq Select 2 (6)	Preset Freq 1 (27)	Preset Freq 2 (28)	Preset Freq 3 (29)	Preset Freq 4 (73)	Preset Freq 5 (74)	Preset Freq 6 (75)	Preset Freq 7 (76)	Accel Time 1 (7)	Decel Time 1 (8)	Accel Time 2 (30)	Decel Time 2 (31)	SW3 TB2-18	SW2 TB2-17	SW1 TB2-16	
Preset ②	Disabled ②	•									•	•			0	0	0	
				•							•	•			0	0	X	
						•						•	•			0	X	0
							•					•	•			0	X	X
			•									•③	•③	■	■	X	0	0
				•								•③	•③	■	■	X	0	X
						•						•③	•③	■	■	X	X	0
						•					•③	•③	■	■	X	X	X	
	Enabled		•									•	•			0	0	0
					•							•	•			0	0	X
						•						•	•			0	X	0
							•					•	•			0	X	X
								•				•	•			X	0	0
									•			•	•			X	0	X
									•		•	•			X	X	0	
									•	•	•			X	X	X		

① The parameter [Freq Source] indicates the active frequency source. See p. 5-45.

② Factory default settings.

③ Not valid for [Input Mode] = "3 W/2nd Acc" or [Input Mode] = "Run F/R 2nd A".

■ Valid for [Input Mode] = "3 W/2nd Acc" or [Input Mode] = "Run F/R 2nd A".

• Indicates active function/parameter. X Indicates closed switch. 0 Indicates open switch. (26) Indicates parameter number.

**Frequency Set Group** (continued)

Table 5.B Accel/Decel Selection

Parameter Settings		Frequency Source ①										Accel/Decel				Control Terminal Block		
Preset/ 2nd Accel(26)	Upper Presets (72)	Freq Select 1 (6)	Freq Select 2 (6)	Preset Freq 1 (27)	Preset Freq 2 (28)	Preset Freq 3 (29)	Preset Freq 4 (73)	Preset Freq 5 (74)	Preset Freq 6 (75)	Preset Freq 7 (76)	Accel Time 1 (7)	Decel Time 1 (8)	Accel Time 2 (30)	Decel Time 2 (31)	SW3 TB2-18	SW2 TB2-17	SW1 TB2-16	
2nd Accel	Disabled ②	•									•	•			0	0	0	
		•										•	•		0	0	X	
		•										•		•	0	X	0	
		•												•	•	0	X	X
			•									•	•			X	0	0
			•										•		•	X	X	0
			•												•	•	X	X
	Enabled	•										•	•			0	0	0
		•											•	•		0	0	X
		•										•			•	0	X	0
		•												•	•	0	X	X
								•				•	•			X	0	0
								•					•	•		X	0	X
								•				•			•	X	X	0
						•						•	•	X	X	X		

① The parameter [Freq Source] indicates the active frequency source. See p. 5-45.

② Factory default settings.

• Indicates active function/parameter.    X Indicates closed switch.    0 Indicates open switch.    (26) Indicates parameter number.

**Frequency Set Group** (continued)

**Table 5.C Motor Operated Potentiometer (MOP) Frequency Source and Accel/Decel Selection**

Parameter Settings		Frequency Source ①		Accel/Decel				Control Terminal Block		
Preset/ 2nd Accel (26)	Upper Presets (72)	Freq Select 1 (5)	Freq Select 2 (6)	Accel Time 1 (7)	Decel Time 1 (8)	Accel Time 2 (30)	Decel Time 2 (31)	SW3 TB2-18	SW2 TB2-17	SW1 TB2-16
Preset or 2nd Accel	Disabled or Enabled	•		•	•			0	MOP Decrement ②	MOP Increment ③
			•			•	•	X	MOP Decrement ②	MOP Increment ③

① The parameter [**Freq Source**] indicates the active frequency source. See p. 5-45.

② MOP Decrement – When this switch is closed, [**MOP Hz**] is decreased at the rate programmed in [**MOP Increment**].

③ MOP Increment – When this switch is closed, [**MOP Hz**] is increased at the rate programmed in [**MOP Increment**].

• Indicates active function/parameter. X Indicates closed switch. 0 Indicates open switch. (26) Indicates parameter number.

**[Analog Filter]**

Selects the amount of software filtering applied to the 0-10 volt analog input and potentiometer input in 25% increments. The lower the percentage, the less filtering applied – allowing faster response to analog signal changes. To obtain higher noise immunity, set the filter value higher.

A value of 100% represents the same amount of filtering as all previous versions of released firmware. With this setting the frequency command rises to 95% of the signal input in 0.5 seconds.

<b>Parameter #</b>	144	<b>Factory Default</b>	100%
<b>Parameter Type</b>	Read & Write	<b>Settings</b>	“0%”
<b>Units</b>	Text		“25%”
			“50%”
			“75%”
			“100%”

## Feature Select

This group contains the necessary parameters to activate and program advanced features of the drive.

### [Run On Power Up]

This parameter enables the function that allows the drive to **automatically restart** on power up regardless of what the drive status was before power is lost. This applies only when there is a maintained input to the start and stop inputs. Refer to Chapter 2, Figure 2.7 through Figure 2.10.

<b>Parameter #</b>	14	<b>Factory Default</b>	"Disabled"
<b>Parameter Type</b>	Read & Write	<b>Settings</b>	"Enabled" "Disabled"
<b>Units</b>	Text		



**ATTENTION:** This parameter may only be used as outlined in NFPA 79, paragraph 6-14 (exceptions 1-3) for specialized applications. Equipment damage and/or personal injury may result if this parameter is used in an inappropriate application.

### [Reset/Run Tries]

This value sets the maximum number of times the drive attempts to reset a fault and restart before the drive issues a "Max Retries Fault." Not operative for faults 9, 10, 11, 24, 25, 26, 29, 30, 32, 33, 34, 35, 38, 39, 40, 41, 42, 43 and 48.

**Important:** [Reset/Run Tries] is a cumulative count. This counter resets to zero if four (4) minutes elapses since the last fault.

<b>Parameter #</b>	85	<b>Factory Default</b>	0
<b>Parameter Type</b>	Read & Write	<b>Minimum</b>	0
<b>Units</b>	Numeric	<b>Maximum</b>	9

**Feature Select Group** (continued)

**[Reset/Run Time]**

This value sets the time between restart attempts when [Reset/Run Tries] is a value other than zero.

**Important:** [Reset/Run Tries] is a cumulative count. This counter resets to zero if four (4) minutes elapses since the last fault.

<b>Parameter #</b>	15	<b>Factory Default</b>	1.0 Sec
<b>Parameter Type</b>	Read & Write	<b>Minimum</b>	0.5 Sec
<b>Units</b>	0.1 Second	<b>Maximum</b>	30.0 Sec

**[S Curve Enable]**

This parameter enables a fixed shape S-Curve.

<b>Parameter #</b>	57	<b>Factory Default</b>	"Disabled"
<b>Parameter Type</b>	Read & Write	<b>Settings</b>	"Enabled" "Disabled"
<b>Units</b>	Text		

**Figure 5.16 S-Curve**

Accel/Decel times are double the active accel/decel time settings.

**Important:** The setting for [S-Curve Time] must be 0.

**Important:** If [Stop Select] is set to "S Curve" then the decel time will be double the active decel setting when a stop command is provided.

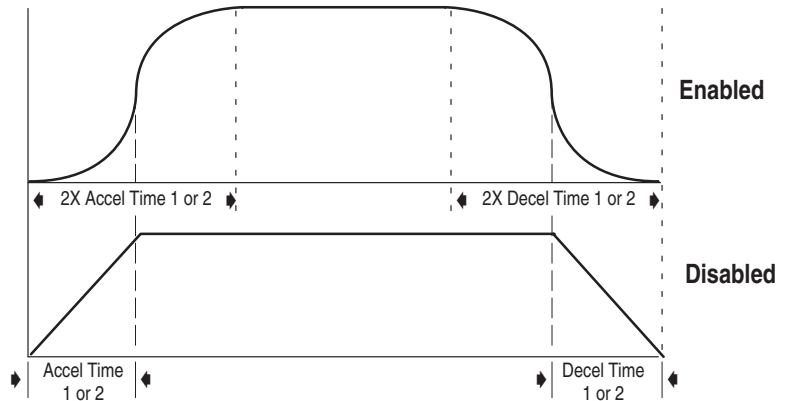

**Feature Select Group** (continued)**[S Curve Time]**

This parameter enables an adjustable shape S-Curve accel/decel time. **Important:** **[S-Curve Time]** must be set to a value less than or equal to the Accel & Decel times.

<b>Parameter #</b>	56	<b>Factory Default</b>	0.0 Sec
<b>Parameter Type</b>	Read & Write	<b>Minimum</b>	0.0 Sec
<b>Units</b>	0.1 Second	<b>Maximum</b>	300.0 Sec

**Figure 5.17 S-Curve Time**

**[S-Curve Enable]** must be “enabled” for this parameter to be active. The **[S-Curve Time]** setting is added to the active accel/decel times to form an adjustable S-Curve.

**Important:** If **[Stop Select]** is set to “S Curve” then the decel time will be double the active decel setting when a stop command is provided.

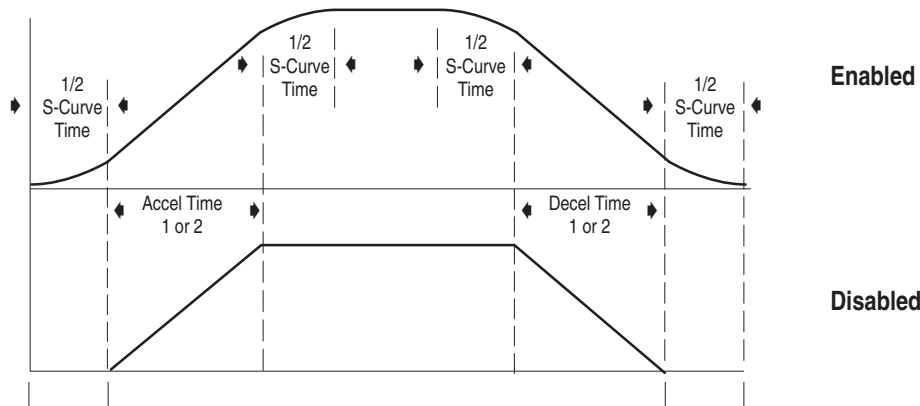
**[Language]**

This parameter selects between English and the alternate second language that can be displayed on the HIM.

<b>Parameter #</b>	47	<b>Factory Default</b>	Alternate language in multilingual versions, English in English only versions.	
<b>Parameter Type</b>	Read & Write	<b>Settings</b>	“English”	or
<b>Units</b>	Text		“French”	
			“Italian”	
			“Spanish”	
			“German”	

**Feature Select Group** (continued)

**[Cable Length]**

This parameter selects the length of cable that is connected to the motor.

**Important:** A setting of “Long” causes the PWM carrier frequency to be fixed at 2 kHz and Voltage Ring-Up Reduction software to be enabled.

**Important:** If “Overload Fault” (F7) occurs – choose “Long” length.

<b>Parameter #</b>	143	<b>Factory Default</b>	“Short”
<b>Parameter Type</b>	Read & Write	<b>Settings</b>	“Short” “Long”
<b>Units</b>	Text		

**[Rated Slip]**

This parameter compensates for the inherent slip in an induction motor. A frequency is added to the commanded output frequency based on torque current. The actual value added may be viewed in **[Slip Comp Adder]** (parameter 148). If motor shaft speed decreases significantly under heavy loads then this value should be increased. A setting of 0.0 Hz disables the function.

This parameter can be set more accurately based on motor nameplate RPM at full load. Use the formula and table shown.

<b>Parameter #</b>	146	<b>Factory Default</b>	2.0 Hz
<b>Parameter Type</b>	Read & Write	<b>Minimum</b>	0.0 Hz
<b>Units</b>	0.1 Hz	<b>Maximum</b>	5.0 Hz

$$\text{Rated Slip} = \left[ \left( \frac{\text{Motor Sync Speed} - \text{Nameplate RPM}}{\text{Motor Sync Speed}} \right) \times \left( \frac{\text{Motor Nameplate Hertz}}{\text{Hertz}} \right) \times \left( \frac{\text{Drive Rated Amps}}{\text{Motor FLA}} \right) \right]$$

**Example**

- Drive** 1 HP, 460V  
2.3 Amps Rated
- Motor** Motor Sync Speed = 1800 RPM  
Nameplate RPM = 1725 RPM  
Nameplate Hertz = 60 Hz  
Motor FLA = 1.7 Amps

<b>Motor Sync Speed</b>		
Poles	60 Hz	50 Hz
2	3600	3000
4	1800	1500
6	1200	1000
8	900	750
12	600	500

$$\text{Rated Slip} = \left[ \left( \frac{1800 - 1725}{1800} \right) \times \left( 60 \right) \times \left( \frac{2.3}{1.7} \right) \right] = 3.38 \text{ Hz}$$

Set **[Rated Slip]** to 3.4 Hz.

Note: Instability may occur if **[Rated Slip]** is set too high with operating frequencies below 10 Hz.

**Feature Select Group** (continued)**[Slip Comp Adder]**

Displays the frequency added to the drive output due to the slip compensation feature. See [Rated Slip] for additional information.

<b>Parameter #</b>	148	<b>Factory Default</b>	None
<b>Parameter Type</b>	Read Only	<b>Minimum</b>	0.00 Hz
<b>Units</b>	0.01 Hz	<b>Maximum</b>	5.00 Hz

**[IR Comp %]**

A voltage is added to the output based on torque current. An additional 31 volts (maximum) is added to 460 volt units to compensate for stator resistance. 15.5 volts is added for 230 volt units. If the drive trips on an Overload fault (F7), or has trouble accelerating to commanded speed, this value should be reduced. A setting of 0% disables this function.

<b>Parameter #</b>	147	<b>Factory Default</b>	See Table		<b>0.37 kW (0.5 HP)</b>	<b>0.55 kW (0.75 HP)</b>	<b>0.75 kW (1 HP)</b>	<b>1.5 kW (2 HP)</b>	<b>2.2 kW (3 HP)</b>	<b>4.0 kW (5 HP)</b>
<b>Parameter Type</b>	Read & Write	<b>Minimum</b>	0%	<b>230V</b>	45%	45%	45%	45%	45%	N/A
<b>Units</b>	1%	<b>Maximum</b>	150%	<b>460V</b>	75%	75%	75%	60%	50%	50%

**Output Configuration**

This group of parameters contains the programming options for digital and analog drive outputs.

**[Output 1 Config]**

This parameter sets the condition that actuates the relay output at TB2, terminals 9 and 10.

<b>Parameter #</b>	90	<b>Factory Default</b>	"Faulted"
<b>Parameter Type</b>	Read & Write		
<b>Units</b>	Text	<b>Settings</b>	"At Speed" <i>Output closes when drive reaches [Freq Command].</i>
			"Above Freq" <i>Output closes when drive exceeds value set in [Above Freq Val].</i>
			"Running" <i>Output closes when drive is running.</i>
			"Faulted" <i>Output closes when drive is faulted.</i>
			"Alarm" <i>Output closes when the drive reaches hardware current limit, software current limit, overvoltage, line loss or 4-20 mA loss.</i>
			"Above Curr" <i>Output closes when current exceeds value set in [Above Curr Val].</i>

**[Output 2 Config]**

This parameter sets the condition that actuates the open collector output at TB2, terminals 19 and 20.

<b>Parameter #</b>	91	<b>Factory Default</b>	"Running"
<b>Parameter Type</b>	Read & Write		
<b>Units</b>	Text	<b>Settings</b>	"At Speed" <i>Output closes when drive reaches [Freq Command].</i>
			"Above Freq" <i>Output closes when drive exceeds value set in [Above Freq Val].</i>
			"Running" <i>Output closes when drive is running.</i>
			"Faulted" <i>Output closes when drive is faulted.</i>
			"Alarm" <i>Output closes when the drive reaches hardware current limit, software current limit, overvoltage, line loss or 4-20 mA loss.</i>
			"Above Curr" <i>Output closes when current exceeds value set in [Above Curr Val].</i>

**Application Note:** During power up of the drive, the customer programmable Outputs 1 & 2 (TB2–9 & 10, TB2– 19 & 20) are in an indeterminate state for a period of time until the internal control of the drive has initialized (3 sec. max.). Any control system connected to the programmable outputs should take this into consideration. On power down, the programmable outputs may transition in a similar way.

**Output Configuration Group** (continued)

<p><b>[Analog Out Sel]</b></p> <p>This parameter selects the value to which the 0-10V DC analog output at TB2-5 is proportional to.</p>	<p><b>Parameter #</b> 25  <b>Parameter Type</b> Read &amp; Write  <b>Units</b> Text</p> <p><b>Factory Default</b> "Frequency"</p> <p><b>Setting</b> "Frequency" 0 to <b>[Maximum Freq]</b>  "Current" 0 to 200% of Rated Drive Output Current  "Bus Volts" 0 to Maximum Bus Voltage— 410V/230V Drives  815V/460V Drives  "Power" 0 to 200% of Drive Rated Output Power  "Output Volts" 0 to Drive Rated Voltage</p>
<p><b>[Above Freq Val]</b></p> <p>This parameter sets the level at which Output 1 or Output 2 will transition when <b>[Output 1 Config]</b> or <b>[Output 2 Config]</b> are set to "Above Freq". This provides an indication that the drive is operating above the programmed frequency value.</p>	<p><b>Parameter #</b> 77  <b>Parameter Type</b> Read &amp; Write  <b>Units</b> 1 Hz</p> <p><b>Factory Default</b> 0 Hz  <b>Minimum</b> 0 Hz  <b>Maximum</b> 400 Hz</p> <p><b>NOTE:</b> This parameter can not be programmed while the drive is running.</p>
<p><b>[Above Curr Val]</b></p> <p>This parameter sets the level at which Output 1 or Output 2 will transition when <b>[Output 1 Config]</b> or <b>[Output 2 Config]</b> are set to "Above Curr". This provides an indication that the drive output current exceeds the programmed value.</p>	<p><b>Parameter #</b> 142  <b>Parameter Type</b> Read &amp; Write  <b>Units</b> 1%</p> <p><b>Factory Default</b> 0% of Drive Rated Current ①  <b>Minimum</b> 0% of Drive Rated Current ①  <b>Maximum</b> 150% of Drive Rated Current ①</p>

① The drive rated output current is based on three phase input ratings. See page 5-13 for Single Phase Input Rating instructions.

# Faults

This group of parameters provides information and programmed settings on commonly viewed drive faults.

<b>[Fault Buffer 0-3]</b>	<b>Parameter #</b>	86-89	<b>Factory Default</b>	None	
	<b>Parameter Type</b>	Read Only			
<p>These parameters store the last (4) faults that occur. If the same fault occurs multiple times in a row, it will only be stored once. <b>[Fault Buffer 0]</b> through <b>[Fault Buffer 3]</b> can only be cleared by “Reset Defaults” from EEPROM mode or <b>[Set Defaults]</b> parameter. This will leave a “F48” in <b>[Fault Buffer 0]</b> and reset all parameters to factory defaults.</p>	<b>Units</b>	Numeric	<b>Buffer</b>	0	
				1	<i>Last Fault, stored in EEPROM</i>
				2	<i>Fault from Buffer 0, Stored in EEPROM</i>
				3	<i>Fault from Buffer 1, Stored in EEPROM</i>
					<i>Fault from Buffer 2, Stored in EEPROM</i>

<b>[Clear Fault]</b>	<b>Parameter #</b>	51	<b>Factory Default</b>	“Ready”	
	<b>Parameter Type</b>	Read & Write			
<p>This parameter is used to clear a fault and return the drive to ready status if the fault condition no longer exists.</p> <p><b>Important:</b> <b>[Clear Fault]</b> will stop a running drive. Also <b>[Clear Fault]</b> does not clear <b>[Fault Buffer 0]</b> through <b>[Fault Buffer 3]</b>.</p>	<b>Units</b>	Text	<b>Displays</b>	“Ready”	<i>Display after function has been attempted</i>
				“Clear Fault”	<i>Attempts to clear fault</i>

**Important:**To clear a fault using parameter #51, press the SEL key once to select the bottom display line. Press the ▲ ▼ keys until “Clear Fault” appears on the bottom display line. Press the ↵ key. This action will attempt to clear the fault. “Ready” will be displayed. Press the ESC key several times to get back to the Status Display and check if the fault has been cleared. If the fault has not been cleared refer to the Troubleshooting section of this manual.

**Faults Group** (continued)

<p><b>[Cur Lim Trip En]</b></p> <p>This setting determines whether or not exceeding the setting in <b>[Current Limit]</b> will cause a Diagnostic Current Limit Fault (Fault F36).</p>	<p><b>Parameter #</b> 82</p> <p><b>Parameter Type</b> Read &amp; Write</p> <p><b>Units</b> Text</p>	<p><b>Factory Default</b> "Default Run"</p> <p><b>Setting</b> "Trip @ I Lim" <i>A Diagnostic Current Limit Fault is generated</i></p> <p>"Default Run" <i>No fault generated</i></p>
<p><b>[Line Loss Fault]</b></p> <p>This setting determines whether a 15% drop in DC Bus voltage will have no effect on operation or cause a "Power Loss Fault" (fault F03).</p> <p><b>Important:</b> The "Line Loss" alarm bit will be set when this condition exists regardless of the parameter setting.</p>	<p><b>Parameter #</b> 40</p> <p><b>Parameter Type</b> Read &amp; Write</p> <p><b>Units</b> Text</p>	<p><b>Factory Default</b> "F03 Enable"</p> <p><b>Setting</b> "UVolt Run" "Power Loss Fault" <i>Disabled</i></p> <p>"FO3 Enable" <i>Drive Trips at 85% of nominal bus voltage.</i></p>

**Faults Group** (continued)

**Line Loss Fault “U Volt Run” (Disabled)**

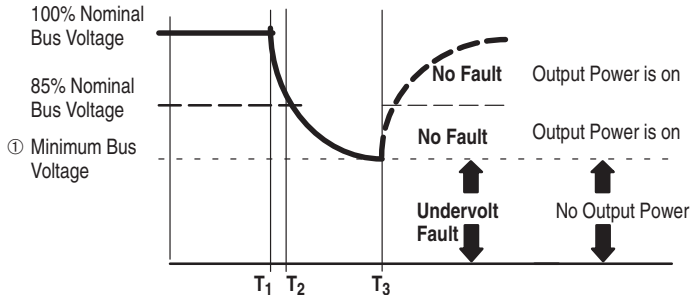

**Line Loss Fault “F03 Enable” (Enabled)**

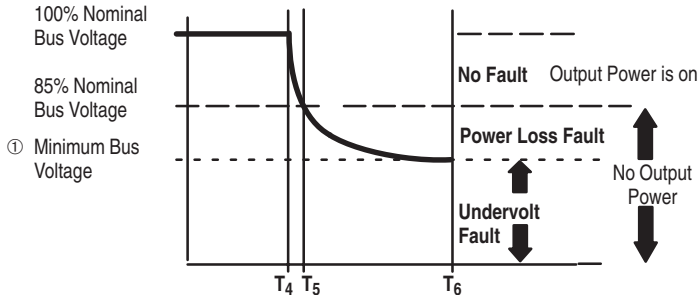

① Minimum bus voltage is approximately 70% of Line Voltage

**Application Notes:** If line loss is set to “U Volt Run” and [Run On Power Up] is enabled, the drive will run as long as the bus voltage is high enough to maintain logic.

To obtain longer power ride-thru, choose “U Volt Run”. This allows the output power to be on from time T<sub>1</sub> to T<sub>3</sub>. To obtain a longer control ride-thru, choose “F03 Enable”. The output power devices are turned off at time T<sub>5</sub> but note that time T<sub>6</sub> – T<sub>5</sub> is greater than time T<sub>3</sub> – T<sub>2</sub>.

**[Fit Clear Mode]**

This parameter controls the method for clearing faults.

<b>Parameter #</b>	39	<b>Factory Default</b>	“Enabled”
<b>Parameter Type</b>	Read & Write		
<b>Units</b>	Text	<b>Setting</b>	“Enabled” “Disabled”
			<i>Faults Cleared By Issuing a Valid Stop Command or Cycling Input Power</i> <i>Faults Cleared Only By Cycling Input Power</i>

**Diagnostics**

This group of parameters contains values that can be helpful in explaining the operation of the drive. Drive status, direction, control and alarm conditions are included.

**[Drive Command]**

This parameter displays the status of the drive commands in an 8-bit binary format.

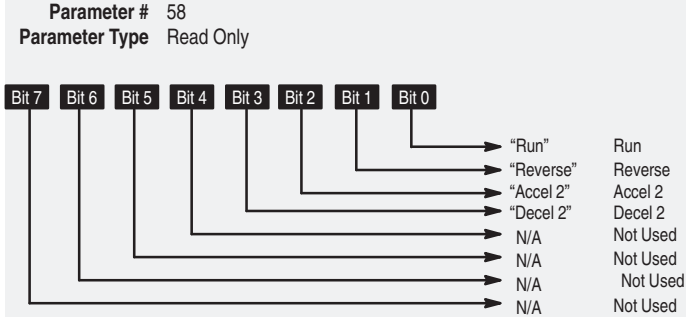

**Diagnostics Group** (continued)

**[Drive Status]**

This parameter displays the actual operating condition in 16 bit binary format.

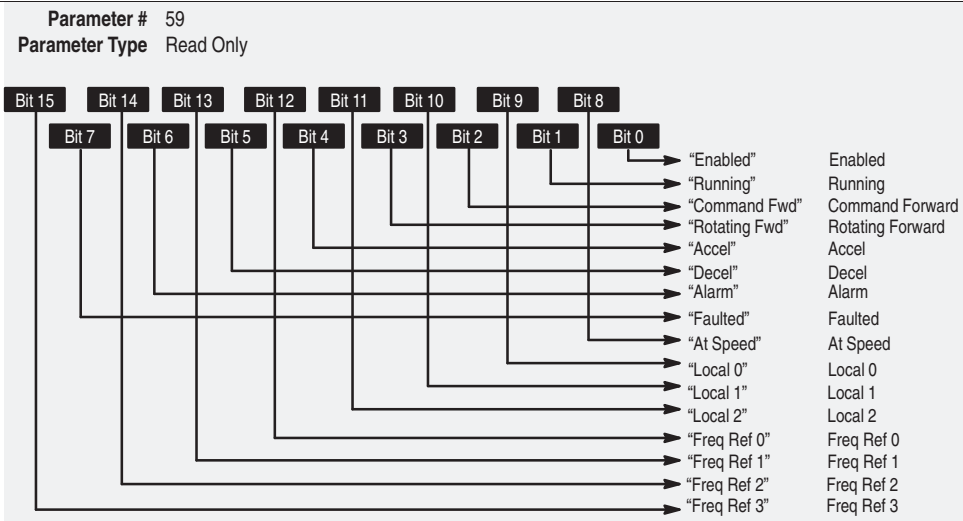

**Diagnostics Group** (continued)**[Drive Alarm]**

This parameter displays which alarm condition is present when bit 6 of **[Drive Status]** is high (set to 1)

Parameter # 60  
Parameter Type Read Only

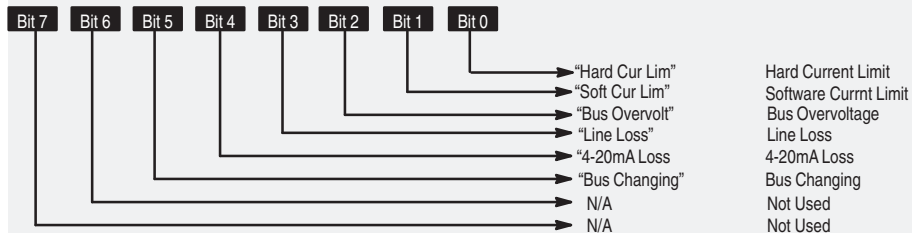
**[Input Status]**

This parameter displays the open (0) and closed (1) status of inputs at TB2. Refer to Figure 2.7 through Figure 2.10 for description of terminal connections.

Parameter # 55  
Parameter Type Read Only

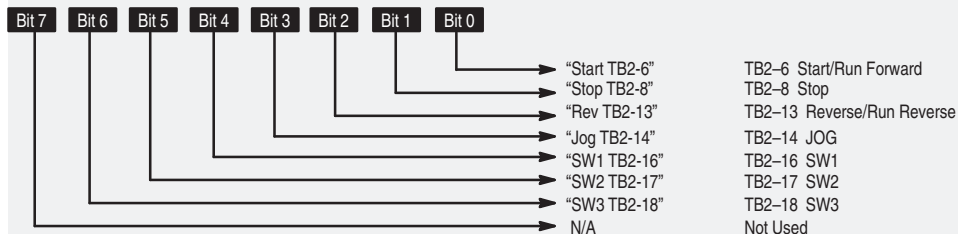

**Diagnostics Group** (continued)

<p><b>[Freq Source]</b></p> <p>This parameter displays the frequency source currently commanding the drive.</p>	<p><b>Parameter #</b> 62  <b>Parameter Type</b> Read  <b>Units</b> Text</p>	<p><b>Displays</b> “Remote Pot” “Preset 1”  “0-10 Volt” “Preset 2”  “4-20 mA” “Preset 3”  “MOP” “Preset 4”  “Adapter 1” “Preset 5”  “Adapter 2” “Preset 6”  “Adapter 3” “Preset 7”  “Adapter 4”  “Adapter 5”  “Adapter 6”</p>
<p><b>[Freq Command]</b></p> <p>This parameter displays the frequency that the drive is commanded to output. This command may come from any one of the frequency sources selected by <b>[Freq Select 1]</b>, <b>[Freq Select 2]</b> or <b>[Preset Freq 1-7]</b> as determined by inputs to SW1, SW2 and SW3 at TB2.</p>	<p><b>Parameter #</b> 65  <b>Parameter Type</b> Read Only  <b>Units</b> 0.01 Hz</p>	<p><b>Factory Default</b> 0.00 Hz  <b>Minimum</b> 0.00 Hz  <b>Maximum</b> 400.00 Hz</p>
<p><b>[Drive Direction]</b></p> <p>This parameter displays the running direction of the drive.</p>	<p><b>Parameter #</b> 69  <b>Parameter Type</b> Read Only  <b>Units</b> Text</p>	<p><b>Factory Default</b> “Forward”  <b>Displays</b> “Forward”  “Reverse”</p>
<p><b>[Motor Mode]</b></p> <p>This parameter is used for internal diagnostic purposes.</p>	<p><b>Parameter #</b> 43  <b>Parameter Type</b> Read Only</p>	

**Diagnostics Group** (continued)

<p><b>[Power Mode]</b></p> <p>This parameter is used for internal diagnostic purposes.</p>	<p><b>Parameter #</b> 44  <b>Parameter Type</b> Read Only</p>	
<p><b>[Drive Type]</b></p> <p>This parameter displays a decimal number that identifies the drive.</p>	<p><b>Parameter #</b> 61  <b>Parameter Type</b> Read Only</p>	
<p><b>[Firmware Ver]</b></p> <p>This parameter displays the version number of the drive firmware.</p>	<p><b>Parameter #</b> 71  <b>Parameter Type</b> Read Only</p>	<p><b>Factory Default</b> None  <b>Display</b> 0.00</p>
<p><b>[Output Pulses]</b></p> <p>This parameter displays the number of output cycles for the PWM waveform. The count rolls over at 65535.</p>	<p><b>Parameter #</b> 67  <b>Parameter Type</b> Read Only  <b>Units</b> 1 Cycle</p>	<p><b>Factory Default</b> None  <b>Minimum</b> 0  <b>Maximum</b> 65535</p>
<p><b>[Drive Temp]</b></p> <p>This parameter displays the internal drive temperature.</p>	<p><b>Parameter #</b> 70  <b>Parameter Type</b> Read Only  <b>Units</b> 1 Degree C</p>	<p><b>Factory Default</b> None  <b>Minimum</b> 0 Degrees C  <b>Maximum</b> 100 Degrees C</p>
<p><b>[Set Defaults]</b></p> <p>Setting parameter to "Default Init" resets all parameters to their factory values. See also page 3-11 EEPROM Mode.</p> <p><b>Note:</b> This parameter can not be programmed while the drive is running.</p>	<p><b>Parameter #</b> 64  <b>Parameter Type</b> Read &amp; Write  <b>Units</b> Text</p>	<p><b>Factory Default</b> "Ready"</p> <p><b>Settings</b> "Ready"  "Store to EE"  "Recll frm EE"  "Default Init"</p> <p><i>Display After Function Complete  Saves parameter Ram to EEPROM  Restores parameter Ram from EEPROM  Resets All Parameters to Their Factory Settings</i></p>

# Masks

This group of parameters contains binary masks for all control functions except the stop command. The masks control which adapters can issue control commands.

Each mask contains a bit for each adapter. Individual bits can be set to "0" to lockout control by an adapter or set to "1" to permit an adapter to have control.

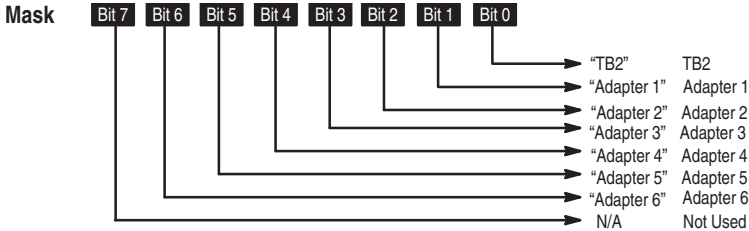

**[Logic Mask]**

This parameter determines which adapters are allowed to control the drive logic commands. Setting a bit to "0" (deny control) disables all command functions except stop and frequency reference. **Important:** In order to remove an adapter from the drive without causing a drive communications fault, the corresponding bit for that adapter must be set to zero. **Important:** This parameter has no effect on the frequency value being sent from TB2 or any of the adapters.

<b>Parameter #</b>	92	<b>Factory Default</b>	01111111	
<b>Parameter Type</b>	Read & Write	<b>Settings</b>	1	<i>Permit Control</i>
<b>Units</b>	Byte		0	<i>Deny Control</i>

**[Direction Mask]**

This parameter determines which adapters can issue forward/reverse commands. **Important:** Terminal Block (TB2) will have control unless masked out.

<b>Parameter #</b>	94	<b>Factory Default</b>	01111111	
<b>Parameter Type</b>	Read & Write	<b>Settings</b>	1	<i>Permit Control</i>
<b>Units</b>	Byte		0	<i>Deny Control</i>

**Masks Group** (continued)

<p><b>[Start Mask]</b></p> <p>This parameter determines which adapters can issue start commands.</p>	<p><b>Parameter #</b> 95  <b>Parameter Type</b> Read &amp; Write  <b>Units</b> Byte</p>	<p><b>Factory Default</b> 01111111</p> <p><b>Settings</b> 1 0</p>	<p>01111111</p> <p><i>Permit Control</i> <i>Deny Control</i></p>
<p><b>[Jog Mask]</b></p> <p>This parameter determines which adapters can issue jog commands.</p>	<p><b>Parameter #</b> 96  <b>Parameter Type</b> Read &amp; Write  <b>Units</b> Byte</p>	<p><b>Factory Default</b> 01111111</p> <p><b>Settings</b> 1 0</p>	<p>01111111</p> <p><i>Permit Control</i> <i>Deny Control</i></p>
<p><b>[Reference Mask]</b></p> <p>This parameter determines which adapters can control the switching between the available freq. reference sources.  <b>Important:</b> Terminal Block (TB2) will have control unless masked out.</p>	<p><b>Parameter #</b> 97  <b>Parameter Type</b> Read &amp; Write  <b>Units</b> Byte</p>	<p><b>Factory Default</b> 01111111</p> <p><b>Settings</b> 1 0</p>	<p>01111111</p> <p><i>Permit Control</i> <i>Deny Control</i></p>
<p><b>[Accel Mask]</b></p> <p>This parameter determines which adapters can switch between <b>[Accel Time 1]</b> and <b>[Accel Time 2]</b>.  <b>Important:</b> Terminal Block (TB2) will have control unless masked out.</p>	<p><b>Parameter #</b> 98  <b>Parameter Type</b> Read &amp; Write  <b>Units</b> Byte</p>	<p><b>Factory Default</b> 01111111</p> <p><b>Settings</b> 1 0</p>	<p>01111111</p> <p><i>Permit Control</i> <i>Deny Control</i></p>
<p><b>[Decel Mask]</b></p> <p>This parameter determines which adapters can switch between <b>[Decel Time 1]</b> and <b>[Decel Time 2]</b>.  <b>Important:</b> Terminal Block (TB2) will have control unless masked out.</p>	<p><b>Parameter #</b> 99  <b>Parameter Type</b> Read &amp; Write  <b>Units</b> Byte</p>	<p><b>Factory Default</b> 01111111</p> <p><b>Settings</b> 1 0</p>	<p>01111111</p> <p><i>Permit Control</i> <i>Deny Control</i></p>

**Masks Group** (continued)

<p><b>[Fault Mask]</b></p> <p>This parameter determines which adapters can reset a fault using input control signals.</p>	<table border="0"> <tr> <td><b>Parameter #</b></td> <td>100</td> <td><b>Factory Default</b></td> <td colspan="2">01111111</td> </tr> <tr> <td><b>Parameter Type</b></td> <td>Read &amp; Write</td> <td></td> <td></td> <td></td> </tr> <tr> <td><b>Units</b></td> <td>Byte</td> <td><b>Settings</b></td> <td>1</td> <td><i>Permit Control</i></td> </tr> <tr> <td></td> <td></td> <td></td> <td>0</td> <td><i>Deny Control</i></td> </tr> </table>	<b>Parameter #</b>	100	<b>Factory Default</b>	01111111		<b>Parameter Type</b>	Read & Write				<b>Units</b>	Byte	<b>Settings</b>	1	<i>Permit Control</i>				0	<i>Deny Control</i>
<b>Parameter #</b>	100	<b>Factory Default</b>	01111111																		
<b>Parameter Type</b>	Read & Write																				
<b>Units</b>	Byte	<b>Settings</b>	1	<i>Permit Control</i>																	
			0	<i>Deny Control</i>																	
<p><b>[MOP Mask]</b></p> <p>This parameter determines which adapters can issue MOP commands to the drive.</p>	<table border="0"> <tr> <td><b>Parameter #</b></td> <td>101</td> <td><b>Factory Default</b></td> <td colspan="2">01111111</td> </tr> <tr> <td><b>Parameter Type</b></td> <td>Read &amp; Write</td> <td></td> <td></td> <td></td> </tr> <tr> <td><b>Units</b></td> <td>Byte</td> <td><b>Settings</b></td> <td>1</td> <td><i>Permit Control</i></td> </tr> <tr> <td></td> <td></td> <td></td> <td>0</td> <td><i>Deny Control</i></td> </tr> </table>	<b>Parameter #</b>	101	<b>Factory Default</b>	01111111		<b>Parameter Type</b>	Read & Write				<b>Units</b>	Byte	<b>Settings</b>	1	<i>Permit Control</i>				0	<i>Deny Control</i>
<b>Parameter #</b>	101	<b>Factory Default</b>	01111111																		
<b>Parameter Type</b>	Read & Write																				
<b>Units</b>	Byte	<b>Settings</b>	1	<i>Permit Control</i>																	
			0	<i>Deny Control</i>																	
<p><b>[Local Mask]</b></p> <p>This parameter determines which adapters can issue a Local command in order to obtain exclusive control of the drive. For safety reasons, local control can only be granted or removed while the drive is <b>not running and is in a safe state</b>. If any adapter is in local control of the drive, all other adapters are locked out and prohibited from controlling any logic function except stop.</p> <p><b>Important:</b> The only way to obtain local control of Bulletin 1305 drives is through the serial port via a PLC command.</p> <p><b>Important:</b> This parameter has no effect on the frequency value being sent from TB2 or any of the adapters..</p>	<table border="0"> <tr> <td><b>Parameter #</b></td> <td>93</td> <td><b>Factory Default</b></td> <td colspan="2">01111111</td> </tr> <tr> <td><b>Parameter Type</b></td> <td>Read &amp; Write</td> <td></td> <td></td> <td></td> </tr> <tr> <td><b>Units</b></td> <td>Byte</td> <td><b>Settings</b></td> <td>1</td> <td><i>Permit Control</i></td> </tr> <tr> <td></td> <td></td> <td></td> <td>0</td> <td><i>Deny Control</i></td> </tr> </table>	<b>Parameter #</b>	93	<b>Factory Default</b>	01111111		<b>Parameter Type</b>	Read & Write				<b>Units</b>	Byte	<b>Settings</b>	1	<i>Permit Control</i>				0	<i>Deny Control</i>
<b>Parameter #</b>	93	<b>Factory Default</b>	01111111																		
<b>Parameter Type</b>	Read & Write																				
<b>Units</b>	Byte	<b>Settings</b>	1	<i>Permit Control</i>																	
			0	<i>Deny Control</i>																	

## Owners

This group of parameters contains binary status information to display which adapters are issuing control commands.

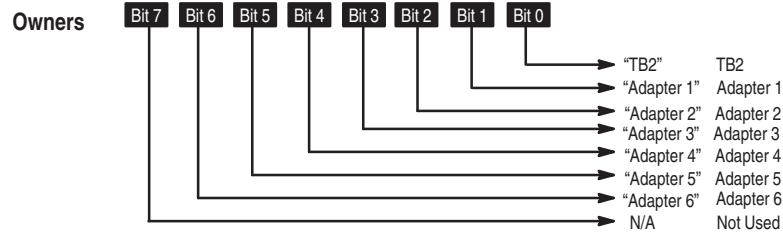
**[Stop Owner]**

This parameter displays which adapters are currently issuing a valid stop command.

<b>Parameter #</b>	102
<b>Parameter Type</b>	Read Only
<b>Units</b>	Byte
<b>Settings</b>	1 0
	<i>Controlling</i> <i>Not Controlling</i>

**[Direction Owner]**

This parameter displays which adapter currently has exclusive control of direction changes. When commanding the direction from an adapter, the corresponding bit is set to "1".

**Important:** Only one adapter is allowed to control direction at any instance.

<b>Parameter #</b>	103
<b>Parameter Type</b>	Read Only
<b>Units</b>	Byte
<b>Settings</b>	1 0
	<i>Controlling</i> <i>Not Controlling</i>

**Owners Group** (continued)

**[Start Owner]**

This parameter displays which adapters are currently issuing Start commands. Since Start commands are edge triggered, multiple adapters can issue the Start command simultaneously and as such are displayed. However, it is the first low to high transition of the Start (once all Stops and/or Faults are removed) that initiates the actual Start command.

<b>Parameter #</b>	104			
<b>Parameter Type</b>	Read Only			
<b>Units</b>	Byte	<b>Settings</b>	1	<i>Controlling</i>
			0	<i>Not Controlling</i>

**[Jog Owner]**

This parameter displays which adapters are currently issuing Jog commands. Since the Jog function is momentary, multiple adapters can issue Jog commands simultaneously. This means that all adapters issuing the Jog must stop commanding the Jog before the function ceases.

**Important:** Stop commands will terminate Jog control and Start commands will override any Jog command.

<b>Parameter #</b>	105			
<b>Parameter Type</b>	Read Only			
<b>Units</b>	Byte	<b>Settings</b>	1	<i>Controlling</i>
			0	<i>Not Controlling</i>

**Owners Group** (continued)

<p><b>[Reference Owner]</b></p> <p>This parameter displays which adapter has exclusive control of selecting the <b>[Freq Source]</b>.</p>	<p><b>Parameter #</b> 106  <b>Parameter Type</b> Read Only  <b>Units</b> Byte</p>	<p><b>Settings</b> 1 0</p>	<p><i>Controlling</i> <i>Not Controlling</i></p>
<p><b>[Accel Owner]</b></p> <p>This parameter displays which adapter currently is exclusively controlling the selection between <b>[Accel Time 1]</b> and <b>[Accel Time 2]</b>.</p>	<p><b>Parameter #</b> 107  <b>Parameter Type</b> Read Only  <b>Units</b> Byte</p>	<p><b>Settings</b> 1 0</p>	<p><i>Controlling</i> <i>Not Controlling</i></p>
<p><b>[Decel Owner]</b></p> <p>This parameter displays which adapter currently is exclusively controlling the selection between <b>[Decel Time 1]</b> and <b>[Decel Time 2]</b>.</p>	<p><b>Parameter #</b> 108  <b>Parameter Type</b> Read Only  <b>Units</b> Byte</p>	<p><b>Settings</b> 1 0</p>	<p><i>Controlling</i> <i>Not Controlling</i></p>
<p><b>[Fault Owner]</b></p> <p>This parameter displays which adapters are currently issuing a <b>[Clear Faults]</b> Command. Multiple adapters can issue simultaneous <b>[Clear Faults]</b> Commands.</p>	<p><b>Parameter #</b> 109  <b>Parameter Type</b> Read Only  <b>Units</b> Byte</p>	<p><b>Settings</b> 1 0</p>	<p><i>Controlling</i> <i>Not Controlling</i></p>

**Owners Group** (continued)

<p><b>[MOP Owner]</b></p> <p>This parameter displays which adapters are currently issuing increases or decreases in MOP Command Frequency. Multiple adapters can issue changes simultaneously to the MOP value.</p>	<table border="0"> <tr> <td><b>Parameter #</b></td> <td>110</td> <td></td> <td></td> <td></td> </tr> <tr> <td><b>Parameter Type</b></td> <td>Read Only</td> <td></td> <td></td> <td></td> </tr> <tr> <td><b>Units</b></td> <td>Byte</td> <td><b>Settings</b></td> <td>1</td> <td><i>Controlling</i></td> </tr> <tr> <td></td> <td></td> <td></td> <td>0</td> <td><i>Not Controlling</i></td> </tr> </table>	<b>Parameter #</b>	110				<b>Parameter Type</b>	Read Only				<b>Units</b>	Byte	<b>Settings</b>	1	<i>Controlling</i>				0	<i>Not Controlling</i>
<b>Parameter #</b>	110																				
<b>Parameter Type</b>	Read Only																				
<b>Units</b>	Byte	<b>Settings</b>	1	<i>Controlling</i>																	
			0	<i>Not Controlling</i>																	

<p><b>[Local Owner]</b></p> <p>This parameter displays which adapter currently has exclusive control of all drive logic functions by requesting a LOCAL command. If an adapter is the <b>[Local Owner]</b>, all other functions (except stop) on all other adapters are locked out and non-functional.</p> <p><b>Important:</b> Local control can only be granted when the drive is in a safe state or stopped.</p>	<table border="0"> <tr> <td><b>Parameter #</b></td> <td>137</td> <td></td> <td></td> <td></td> </tr> <tr> <td><b>Parameter Type</b></td> <td>Read Only</td> <td></td> <td></td> <td></td> </tr> <tr> <td><b>Units</b></td> <td>Byte</td> <td><b>Settings</b></td> <td>1</td> <td><i>Controlling</i></td> </tr> <tr> <td></td> <td></td> <td></td> <td>0</td> <td><i>Not Controlling</i></td> </tr> </table>	<b>Parameter #</b>	137				<b>Parameter Type</b>	Read Only				<b>Units</b>	Byte	<b>Settings</b>	1	<i>Controlling</i>				0	<i>Not Controlling</i>
<b>Parameter #</b>	137																				
<b>Parameter Type</b>	Read Only																				
<b>Units</b>	Byte	<b>Settings</b>	1	<i>Controlling</i>																	
			0	<i>Not Controlling</i>																	

## Adapter I/O

This group contains the parameters needed for an optional communications adapter to communicate with the drive.

### [Data In A1 through D2]

These parameters are used to write real time data values from a source controller (PLC, SLC, etc.) to the drive. This is accomplished by programming a parameter number into the [Data In] parameters. The value programmed into the source controller's output image table will be written to the drive parameter identified in the corresponding [Data In] parameter.

**Parameter #** 111 - 118

**Parameter Type** Read & Write

Parameter	Bulletin 1305 drive
111	Data In A1 ←
112	Data In A2 ←
113	Data In B1 ←
114	Data In B2 ←
115	Data In C1 ←
116	Data In C2 ←
117	Data In D1 ←
118	Data In D2 ←

Controller Output Image Table (i.e. PLC, SLC, etc.)

**Important:** addressing information that defines which controller I/O address corresponds to a [Data In] parameter is determined by the dip switch settings on the external communication module. Refer to the appropriate Bulletin 1203 Communication Module User Manual for details.

Refer to Appendix B for additional information.

**Important:** The drive parameter that is accessed indirectly using Data In will not be stored permanently and automatically to EEPROM (due to the high potential update rate from a PLC). A manual operation is necessary for permanent storage. The HIM EEPROM command, Save Values, or using parameter (64) [Set Defaults] will perform this task. Similarly, to restore the values to the ones the drive had before Data In was configured, the HIM Recall Values Function can be used.

### [Data Out A1 through D2]

These parameters are used to write real time data values from the drive to a destination controller. This is accomplished by programming a parameter number into the [Data Out] parameters. The real time value of that parameter will be written to the input image table of the destination controller.

**Parameter #** 119 - 126

**Parameter Type** Read & Write

Parameter	Bulletin 1305 drive
119	Data Out A1 →
120	Data Out A2 →
121	Data Out B1 →
122	Data Out B2 →
123	Data Out C1 →
124	Data Out C2 →
125	Data Out D1 →
126	Data Out D2 →

Controller Input Image Table (i.e. PLC, SLC, etc.)

**Important:** addressing information that defines which controller I/O address corresponds to a [Data Out] parameter is determined by the dip switch settings on the external communication module. Refer to the appropriate Bulletin 1203 Communication Module User Manual for details.

Refer to Appendix B for additional information.

## Process Display

This group contains parameters that can be used to display a drive parameter in “User Units.”

### [Process Par]

This parameter should be set to the number of the parameter whose scaled value will be displayed on **Line 1** of the HIM Display Panel when in process mode.

<b>Parameter #</b>	127	<b>Factory Default</b>	1
<b>Parameter Type</b>	Read & Write	<b>Minimum</b>	1
<b>Units</b>	Numeric	<b>Maximum</b>	Max. Parameter Number

### [Process Scale]

This value sets the scaling multiplier for [Process Par]. The displayed value will be:

$$\begin{aligned} & \text{[Process Par] actual value} \\ \times & \text{ [Process Scale] value} \\ \hline & \text{Displayed Value } \textcircled{1} \end{aligned}$$

<b>Parameter #</b>	128	<b>Factory Default</b>	+1.00
<b>Parameter Type</b>	Read & Write	<b>Minimum</b>	-327.68
<b>Units</b>	Numeric	<b>Maximum</b>	+327.67

### [Process Txt 1-8]

These parameters set the “User Units” description for the value determined by [Process Par] and [Process Scale]. This text is displayed on Line 1 of the HIM.

<b>Parameter #(s)</b>	129-136	<b>Factory Default</b>	“?”
<b>Parameter Type</b>	Read & Write		
<b>Units</b>	ASCII Text Character		

<sup>①</sup> The maximum value that can be displayed is 99,999.99. If this value is exceeded a character string of asterisks (\*\*\*\*\* ) will appear on the display.

## Linear List

This group lists all parameters in numerical order.

1	Output Voltage	27	Preset Freq 1	53	DC Bus Voltage	84	Analog Invert	110	MOP Owner	136	Process Text 8
2	% Output Curr	28	Preset Freq 2	54	Output Current	85	Reset/Run Tries	111	Data In A1	137	Local Owner
3	% Output Power	29	Preset Freq 3	55	Input Status	86	Fault Buffer 0	112	Data In A2	141	Sec Curr Limit
4	Last Fault	30	Accel Time 2	56	S Curve Time	87	Fault Buffer 1	113	Data In B1	142	Above Curr Val
5	Freq Select 1	31	Decel Time 2	57	S Curve Enable	88	Fault Buffer 2	114	Data In B2	143	Cable Length
6	Freq Select 2	32	Skip Freq 1	58	Drive Command	89	Fault Buffer 3	115	Data In C1	144	Analog Filter
7	Accel Time 1	33	Skip Freq 2	59	Drive Status	90	Output 1 Config	116	Data In C2	146	Rated Slip
8	Decel Time 1	34	Skip Freq 3	60	Drive Alarm	91	Output 2 Config	117	Data In D1	147	IR Comp %
9	DC Boost Select	35	Skip Freq Band	61	Drive Type	92	Logic Mask	118	Data In D2	148	Slip Comp Adder
10	Stop Select	36	Current Limit	62	Freq Source	93	Local Mask	119	Data Out A1	149	Adaptive I Lim
11	DB Enable	37	Overload Mode	64	Set Defaults	94	Direction Mask	120	Data Out A2		
12	DC Hold Time	38	Overload Current	65	Freq Command	95	Start Mask	121	Data Out B1		
13	DC Hold Volts	39	Fit Clear Mode	66	Output Freq	96	Jog Mask	122	Data Out B2		
14	Run On Power Up	40	Line Loss Fault	67	Output Pulses	97	Reference Mask	123	Data Out C1		
15	Reset/Run Time	41	Motor Type	69	Drive Direction	98	Accel Mask	124	Data Out C2		
16	Minimum Freq	42	MOP Hertz	70	Drive Temp	99	Decel Mask	125	Data Out D1		
17	Base Frequency	43	Motor Mode	71	Firmware Ver	100	Fault Mask	126	Data Out D2		
18	Base Voltage	44	Power Mode	72	Upper Presets	101	MOP Mask	127	Process Par		
19	Maximum Freq	45	PWM Frequency	73	Preset Freq 4	102	Stop Owner	128	Process Scale		
20	Maximum Voltage	46	Current Angle	74	Preset Freq 5	103	Direction Owner	129	Process Text 1		
21	Input Mode	47	Language	75	Preset Freq 6	104	Start Owner	130	Process Text 2		
22	MOP Increment	48	Start Boost	76	Preset Freq 7	105	Jog Owner	131	Process Text 3		
23	Output Power	49	Break Frequency	77	Above Freq Val	106	Reference Owner	132	Process Text 4		
24	Jog Frequency	50	Break Voltage	81	4–20mA Loss Sel	107	Accel Owner	133	Process Text 5		
25	Analog Out Sel	51	Clear Fault	82	Cur Lim Trip En	108	Decel Owner	134	Process Text 6		
26	Prst/2nd Accel	52	Compensation	83	Run Boost	109	Fault Owner	135	Process Text 7		

### CHAPTER OBJECTIVES

Chapter 6 provides information to guide the user in understanding drive fault conditions and general troubleshooting procedures for 1305 drives. Included is a listing and description of the various drive faults with possible solutions, when applicable. General troubleshooting is presented in Table 6.C.

### FAULT INFORMATION

Figure 6.1 Fault Display



Drives equipped with a Human Interface Module will display a brief fault message on Line 1 of the LCD display when a fault occurs. Line 2 of the display indicates the corresponding fault number. **Important:** For Series A HIM software version 3.00 and Above or Series B HIM software version 1.01 and Above, faults are displayed as soon as they occur. Earlier HIM versions only display faults when the HIM is in the Status Display Mode. [Fault Buffer 0] through [Fault Buffer 3] display previous faults.

Table 6.A lists all faults numerically with a cross reference to the page number where information can be found relating to that fault. Table 6.B provides an alphabetized listing of the faults with a description and possible corrective action to take.

### Fault LED

All drives come equipped with a fault LED. When the fault LED is illuminated it is an indication a fault condition exists. Refer to page 2-3 for the location of the fault LED. Once the fault is properly cleared the LED will return to an off state.

### Diagnostics

As can be seen in Figure 2.3, there are two indicators provided to display the drive's status condition. The DC Bus Charge Indicator is a neon bulb that will be illuminated when power is applied to the drive. The Fault Indicator is an LED that will be illuminated if a drive fault condition exists. Refer to details on How To Clear a Fault, below.

### How To Clear a Fault

**Important:** Resetting a fault will not correct the cause of the fault condition. Corrective action must be taken prior to resetting the fault.

To clear a fault perform one of the following:

1. Cycle power to the drive.
2. Cycle the stop signal to the drive.
3. Cycle the [Clear Fault] parameter. See page 5-39.

**Important:** The stop signal will not clear a fault if the [Logic Mask] or [Fault Mask] bit of that adapter has been disabled or the [Fault Clear Mode] parameter is disabled.

Table 6.A Fault Code Cross Reference

Fault Number	Fault Name	Page
F3	Power Loss Fault	6-7
F4	Undervolt Fault	6-8
F5	Overvolt Fault	6-6
F6	Motor Stall Fault	6-5
F7	Overload Fault	6-6
F8	Overtemp Fault	6-6
F9	Open Pot Fault	6-5
F10	Serial Fault	6-7
F11	Op Error Fault	6-5
F12	Overcurrent Flt	6-6
F22	Drive Reset Flt	6-3
F24	Motor Mode Flt	6-5
F25	Overspeed Flt	6-6
F26	Power Mode Fault	6-7
F29	Hz Err Fault	6-3
F30	Hz Sel Fault	6-3
F32	EEprom Fault	6-3
F33	Max Retries Fault	6-4
F34	Run Boost Fault	6-7
F35	Neg Slope Fault	6-5

Fault Number	Fault Name	Page
F36	Diag C Lim Flt	6-3
F38	Phase U Fault	6-6
F39	Phase V Fault	6-6
F40	Phase W Fault	6-6
F41	UV Short Fault	6-8
F42	UW Short Fault	6-8
F43	VW Short Fault	6-8
F44	IPM Current Fault	6-4
F45	IPM Overtemp Fault	6-4
F46	Power Test Fault	6-6
F48	Reprogram Fault	6-7
–	Drive → HIM <sup>①</sup>	6-3
–	HIM → Drive <sup>①</sup>	6-4
–	Network Error * <sup>①</sup>	6-5
–	Pin ID Error <sup>①</sup>	6-7

<sup>①</sup> These faults are generated in the HIM and not stored in the drive EEPROM.

**Table 6.B 1305 Fault Descriptions**

Name & Fault Number	Description	Action to Take
<b>Diag C Lim Fault</b> F36	The drive output current has exceeded the software <b>[Current Limit]</b> and the <b>[Cur Lim Trip En]</b> parameter was enabled.	Check programming of <b>[Curr Lim Trip En]</b> parameter. Check for excess load, improper DC boost setting, DC brake volts set too high or other causes of excess current.
<b>Drive → HIM</b>	The checksum read from the HIM's EEPROM does not match the checksum calculated from the EEPROM data.	Repeat operation. Replace HIM.
<b>Drive Reset Fault</b> F22	Occurs on power-up. Caused by having the Start Input (or Run Input) closed, with the Stop Input open and <b>[Run On Power Up]</b> = Disabled.	Check stop connection at TB2, terminal 8.
<b>EEprom Fault</b> F32	EEPROM has invalid data or can not be programmed to valid data.	Check cable connection from main control board to power board. Reset to Default Parameters and Cycle power.
<b>Hz Err Fault</b> F29	This fault indicates that there is not a valid operating frequency. It can be caused by any of the following: <ol style="list-style-type: none"> <li>1. <b>[Maximum Frequency]</b> is less than <b>[Minimum Freq]</b>.</li> <li>2. Skip frequencies and skip bandwidth eliminate all operating frequencies.</li> <li>3. 4-20mA input signal speed reference has been lost or is out of range and <b>[4-20mA Loss Sel]</b> is set for "Stop-Fault."</li> </ol>	<ol style="list-style-type: none"> <li>1. Check <b>[Minimum Freq]</b> and <b>[Maximum Freq]</b> parameters.</li> <li>2. Check <b>[Skip Freq 1]</b>, <b>[Skip Freq 2]</b>, <b>[Skip Freq 3]</b> and <b>[Skip Freq Band]</b> parameters.</li> <li>3. Check for broken wires, loose connections or transducer loss at 4-20mA input, TB2.</li> </ol>
<b>Hz Sel Fault</b> F30	An adapter that is not connected has been chosen as the active frequency source.	Connect proper adapter or change active frequency source.

**Table 6.B 1305 Fault Descriptions** (continued)

Fault Name & Number	Fault Description	Action to Take
<b>HIM → Drive</b>	<p>Error 1 – The checksum read from the HIM's EEPROM does not match the checksum calculated from the EEPROM data.</p> <p>Error 2 – The number of parameters in saved profile does not equal master.</p> <p>Error 3 – Download was attempted to a different type drive (i.e. 1336-&gt;1305).</p> <p>Error 4 – Saved data for parameter not correct for new drive.</p> <p>Error 5 – Drive is running while attempting download.</p>	<p>Repeat operation. Old profile corrupt. Save new profile. Repeat operation.</p> <p>The last parameter programmed will be displayed on the top line. Verify that all parameters have been programmed. If not, manually program any remaining parameters.</p> <p>Download can only take place with the same type of drive.</p> <p>Capabilities of drive are different than the master drive. Press Enter to continue download. When download is complete, manually program the parameter where the error occurred.</p> <p>Stop drive, then perform download.</p>
<b>IPM Current Fault</b> F44	The internal power module overcurrent limit had been exceeded.	Check for short circuit at the drive output or excessive load conditions at the motor, specifically cable capacitance to ground.
<b>IPM Overtemp Fault</b> F45	The internal power module thermal limit has been exceeded.	Check for blocked or dirty heat sink fins. Check for proper mounting and spacing (See page 2-1). Check if the ambient temperature limit has been exceeded.
<b>Max Retries Fault</b> F33	Drive unsuccessfully attempted to reset a fault and resume running for the programmed number of <b>[Reset/Run Tries]</b> .	Check fault buffer for fault code requiring reset. Correct the cause of the fault and manually clear by cycling the stop command or cycling power.

**Table 6.B 1305 Fault Descriptions** *(continued)*

Fault Name & Number	Fault Description	Action to Take
<b>Motor Mode Flt</b> F24	Internal error.	Reset drive to factory defaults.
<b>Motor Stall Fault</b> F6	The motor is stalled.	If the motor is drawing excessive current, the motor load is excessive and will not allow the drive to accelerate to set speed. A longer accel time or a reduced load may be required.
<b>Neg Slope Fault</b> F35	Drive software detected a portion of the volts/Hz curve with a negative slope.	Check drive programming. <ol style="list-style-type: none"> <li>1. <b>[Base Voltage]</b> parameter must be greater than 1.5 X <b>[Start Boost]</b>.</li> <li>2. If the <b>[DC Boost Select]</b> parameter is set to “Break Point,” <b>[Base Voltage]</b> must be greater than <b>[Break Voltage]</b> and <b>[Break Voltage]</b> must be greater than <b>[Start Boost]</b>.</li> </ol>
<b>Network Error *</b>	Network Error 0 – Error 6      ScanPort Error Network Error 7 – Error 9      Communications Error	<ol style="list-style-type: none"> <li>1. Press the “UP” or “DOWN” arrow to clear the message from the HIM display.</li> <li>2. Unplug the HIM from the cable or drive and re-connect.</li> <li>3. Check for external noise sources.</li> </ol>
<b>Op Error Fault</b> F11	<b>[Motor Type]</b> is set to “Sync PM” and <b>[Stop Mode]</b> is set to “DC Brake”.	Change one of these parameters. DC Braking cannot be used with a synchronous motor.
<b>Open Pot Fault</b> F9	An external pot is connected and the ground lead of the pot is disconnected creating a potential drive overspeed hazard.	Check the external potentiometer circuit at TB2, terminals 1, 2 and 3 for an open circuit.

**Table 6.B 1305 Fault Descriptions** *(continued)*

Fault Name & Number	Fault Description	Action to Take
<b>Overcurrent Fault</b> F12	Overcurrent is detected in overcurrent hardware trip circuit.	Check for a short circuit at the drive output or excessive load conditions at the motor.
<b>Overload Fault</b> F7	Internal electronic overload trip.	An excessive motor load exists. It must be reduced such that drive output current does not exceed the % of current set by the <b>[Overload Current]</b> parameter. Reduce <b>[Start Boost]</b> if applicable. Change <b>[Cable Length]</b> to “Long” if applicable.
<b>Overspeed Fault</b> F25	Internal error.	Reset drive to factory defaults.
<b>Overtemp Fault</b> F8	Temperature sensor detects excessive heat.	Check for blocked or dirty heat sink fins. Check for proper mounting and spacing (See page 2-1). Check if the ambient temperature limit has been exceeded.
<b>Overvolt Fault</b> F5	DC bus voltage exceeded maximum value.	Monitor the AC line for high line voltage or transient conditions. Bus overvoltage can also be caused by motor regeneration. Extend the decel time or install dynamic brake option.
<b>Phase U Fault</b> F38	A phase to ground fault has been detected between the drive and motor in this phase.	Check the wiring between the drive and motor. Check motor for grounded phase.
<b>Phase V Fault</b> F39	A phase to ground fault has been detected between the drive and motor in this phase.	Check the wiring between the drive and motor. Check motor for grounded phase.
<b>Phase W Fault</b> F40	A phase to ground fault has been detected between the drive and motor in this phase.	Check the wiring between the drive and motor. Check motor for grounded phase.

**Table 6.B 1305 Fault Descriptions** *(continued)*

<b>Fault Name &amp; Number</b>	<b>Fault Description</b>	<b>Action to Take</b>
<b>Pin ID Error</b>	Communication Hardware problem.	1. Unplug the HIM from the cable or drive and re-connect. 2. Replace Communication Cable.
<b>Power Loss Fault</b> F3	DC bus voltage remained below 85% of nominal for longer than 0.500 sec. <b>[Line Loss Fault]</b> parameter is programmed to "F03 Enable".	Monitor the incoming AC line for low voltage or line power interruption.
<b>Power Mode Fault</b> F26	Internal error.	Reset drive to factory defaults.
<b>Power Test Fault</b> F46	Fault detected during initial start-up sequence.	Check drive wiring. Check motor wiring. Reset drive to factory defaults.
<b>Reprogram Fault</b> F48	Occurs when drive parameters are reset to defaults.	Clear fault.
<b>Run Boost Fault</b> F34	An attempt has been made to set the <b>[Run Boost]</b> parameter to a value greater than the <b>[Start Boost]</b> parameter.	Verify that parameter has been programmed correctly.
<b>Serial Fault</b> F10	An active local bus adapter is disconnected while it possesses control of a local bus function.	Check for break in communications line.

**Table 6.B 1305 Fault Descriptions** *(continued)*

<b>Fault Name &amp; Number</b>	<b>Fault Description</b>	<b>Action to Take</b>
<b>Undervolt Fault</b> F4	DC Bus voltage fell below the minimum value. [ <b>Line Loss Fault</b> ] parameter is programmed to "U Volt Run".	Monitor the incoming AC line for low voltage or line power interruption.
<b>UV Short Fault</b> F41	Excessive current has been detected between these two drive output terminals.	Check the motor and external wiring to the drive output terminals for a shorted condition.
<b>UW Short Fault</b> F42	Excessive current has been detected between these two drive output terminals.	Check the motor and external wiring to the drive output terminals for a shorted condition.
<b>VW Short Fault</b> F43	Excessive current has been detected between these two drive output terminals.	Check the motor and external wiring to the drive output terminals for a shorted condition.

**Table 6.C Troubleshooting**

General Problem	Action to Take
Motor does not start (No output voltage to motor) ("Stopped" is displayed on the HIM).	<ol style="list-style-type: none"> <li>(1) Check power circuit                             <ul style="list-style-type: none"> <li>- Check supply voltage.</li> <li>- Check all fuses and disconnects.</li> </ul> </li> <li>(2) Check motor                             <ul style="list-style-type: none"> <li>- Verify that motor is connected properly.</li> </ul> </li> <li>(3) Check control input signals.                             <ul style="list-style-type: none"> <li>- Verify that Enable signal is present. ("Not Enabled" is displayed on the HIM)</li> <li>- Verify that Start signal is present.</li> <li>- Verify that Stop signal is present.</li> <li>- Verify that Run Forward and Run Reverse signals are NOT both active.</li> </ul> </li> <li>(4) Check parameter mask settings                             <ul style="list-style-type: none"> <li>- Verify that <b>[Start Mask]</b> is set properly.</li> <li>- Verify that <b>[Logic Mask]</b> is set properly.</li> <li>- Verify that <b>[Local Mask]</b> is set properly.</li> </ul> </li> </ol>
Drive Started but motor NOT rotating. ("At Speed 0.00 Hz" is displayed on HIM).	<ol style="list-style-type: none"> <li>(1) Check motor                             <ul style="list-style-type: none"> <li>- Verify that motor is connected properly.</li> </ul> </li> <li>(2) Check Frequency Source                             <ul style="list-style-type: none"> <li>- Verify that frequency signal is present at terminal block TB2.                                     <ul style="list-style-type: none"> <li>- 4-20mA signal</li> <li>- 0-10V signal</li> <li>- Remote Potentiometer</li> </ul> </li> <li>- Verify that Adapter or Preset Frequencies are set properly.</li> </ul> </li> <li>(3) Check control input signals.                             <ul style="list-style-type: none"> <li>- Verify that SW1, SW2 and SW3 are in the proper state. (Refer to Table 5.A on page 5-29)</li> </ul> </li> <li>(4) Check parameter settings and charts on Pages 5-29 and 5-30.                             <ul style="list-style-type: none"> <li>- Verify that <b>[Freq Source]</b> is showing the desired frequency source.</li> <li>- Verify that <b>[Freq Command]</b> is the desired value.</li> <li>- Verify that <b>[Reference Mask]</b> is set properly.</li> </ul> </li> </ol>

**Table 6.C Troubleshooting** (continued)

General Problem	Action to Take
Motor not accelerating properly.	(1) Check motor <ul style="list-style-type: none"> <li>- Verify that motor is connected properly.</li> <li>- Verify that no mechanical problems exist.</li> </ul> 2) Check control input signals <ul style="list-style-type: none"> <li>- Verify that SW1, SW2, and SW3 are in the proper state to select desired Accel/Decel rates. (Refer to Table 5.A on page 5-29)</li> </ul> (4) Check parameter settings and charts on Pages 5-29 and 5-30. <ul style="list-style-type: none"> <li>- Verify that <b>[Accel Time 1]</b> and <b>[Accel Time 2]</b> are set properly.</li> <li>- Verify that <b>[Current Limit]</b> is set properly.</li> <li>- Verify that <b>[DC Boost Select]</b> is set correctly.</li> <li>- Verify that <b>[Start Boost]</b> and <b>[Run Boost]</b> are set properly.</li> </ul>
Specific Problem	Action to Take
Can not Jog from Adapter.	(1) Verify that <b>[Jog Mask]</b> is set properly to allow jogging from that adapter. (2) Verify that <b>[Logic Mask]</b> is set properly to allow jogging from that adapter. (3) Is drive already running? (4) Examine <b>[Stop Owner]</b> to verify that a maintained Stop does not exist.
Can not change direction from Adapter.	(1) Verify that <b>[Direction Mask]</b> is set to allow direction changes from that adapter. (2) Verify that <b>[Logic Mask]</b> is set to allow direction changes from that adapter.
Can not Start from Adapter.	(1) Verify that <b>[Start Mask]</b> is set properly to allow starting from that adapter. (2) Verify that <b>[Logic Mask]</b> is set properly to allow starting from that adapter. (3) Is drive already running? (4) Examine <b>[Stop Owner]</b> to verify that a maintained Stop does not exist.
Display indicates "Not Enabled".	(1) Check enable signal at TB2, terminals 11 & 12.

**Table 6.C Troubleshooting** *(continued)*

<b>Specific Problem</b>	<b>Action to Take</b>
Can not operate in "Run Fwd/Run Rev" mode.	(1) Verify that <b>[Input Mode]</b> is set correctly. (2) Has power been cycled for above change to take effect? (3) Are both Run Forward and Run Reverse switches active?
Can not change speed from Adapter.	(1) Verify that the speed source is the adapter in question. (examine <b>[Freq Source]</b> parameter).
Can not operate drive without HIM.	(1) Verify that SW1, SW2, and SW3 are in the proper state to select the desired speed source. (Refer to charts on Pages 5-29 and 5-30) (2) Verify that <b>[Freq Source]</b> and <b>[Freq Command]</b> are desired values.
Drive faults when Adapter is unplugged.	(1) Verify that <b>[Logic Mask]</b> is set properly to allow removal of a particular Adapter while drive is powered up. (2) Verify that the adapter being unplugged is not the active frequency source.
Pin ID Error is displayed on HIM.	(1) Unplug the HIM from the cable or drive and re-connect.
"Network Error ✱" is displayed on the HIM.	(1) Press the "Up" or "Down" arrow to clear the message from the HIM display. (2) Unplug the HIM from the cable or drive and re-connect.
Can not clear fault from Adapter or Terminal Block with stop command.	(1) Verify that <b>[Fault Clear Mode]</b> is set to "Enabled" (2) Verify that <b>[Fault Mask]</b> is set to allow clearing of faults from chosen device. (3) Verify that <b>[Logic Mask]</b> is set properly.

**This Page Intentionally Left Blank.**

## BLOCK DIAGRAM

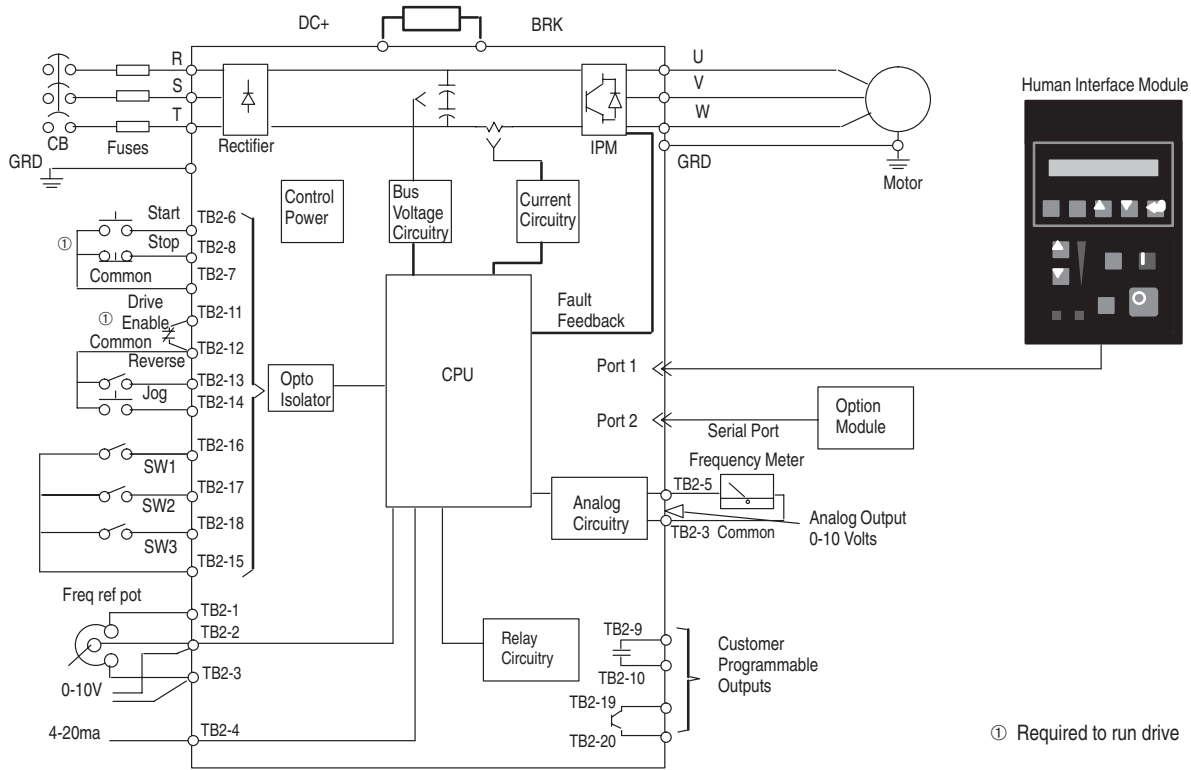

Table A.1 Specifications

Drive	Bulletin 1305 Drive Rated 200-230 V AC					Bulletin 1305 Drives Rated 380-460 V AC					
	-AA02A	-AA03A	-AA04A	-AA08A	-AA12A	-BA01A	-BA02A	-BA03A	-BA04A	-BA06A	-BA09A
<b>OUTPUT RATINGS</b>											
Three-Phase Motor Rating kW (HP)	0.37 (0.5)	0.55 (0.75)	0.75 (1)	1.5 (2)	2.2 (3)	0.37 (0.5)	0.55 (0.75)	0.75 (1)	1.5 (2)	2.2 (3)	4.0 (5)
Output Current (A) ①②	2.3	3.0	4.5	8.0	12.0 ③	1.3	1.6	2.3	4.0	6.0 ④	9.0 ⑤
Output Voltage	Adjustable from 0 V to Input Voltage										
Output Frequency (Hz)	0.00 to 400.00 Hz Programmable										
SCANport Load	250 mA maximum (all adapters combined)										
<b>INPUT RATINGS</b>											
Input Voltage & Frequency	200/230V Three Phase, 50/60 Hz					380/460V Three Phase, 50/60 Hz					
Operational Range (V)	180-265V, 47-63 Hz					340V-500V, 47-63 Hz					
Input kVA	0.9	1.3	1.7	3.1	4.6	0.9	1.3	1.7	3.1	4.6	7.0
Power Factor (Displacement)	0.8 (Lagging)										
Efficiency (%)	97.5 % (Typical)										
Power Dissipation (W)	27	34	46	76	108	21	27	34	52	73	107

In general:

- ① Motor Full Load Amps (FLA) should not exceed the drive output current rating.  
 ② If the [PWM Frequency] is set above 4kHz, the output current must be derated per the chart on page 5-20.

When operating the drive in an ambient temperature at or near the maximum operating temperature (50°C), the following derating guidelines are recommended to guard against overheating depending on application and operating conditions.

- ③ Output current value listed for 200V input voltage. At 230V input voltage, output current is 9.6A for 3 phase and 6.8A for single phase.  
 ④ Output current value listed for 380V input voltage. At 415V input voltage, output current is 5.3A. At 460V input voltage, output current is 4.8A.  
 ⑤ Output current value listed for 380V input voltage. At 415V input voltage, output current is 8.4A. At 460V input voltage, output current is 7.6A.

For derating guidelines at ambient temperatures between 40°C and 50°C, consult Allen-Bradley.

**Table A.1 Specifications** *(continued)*

<b>ENVIRONMENTAL SPECIFICATIONS</b>	
Enclosure	NEMA 1 (IP30) standard
Ambient Temperature	0 to 50°C; Optional Enclosures: 0 to 40°C
Storage Temperature	-40°C to 70°C
Relative Humidity	0 to 95% (non condensing)
Vibration	1.0 G Operational
Cooling Method	Natural Convection (no fans)
Altitude	Above 1,000 m (3,300 ft), derate at 6% of drive rated amps per 1000 m
<b>CONTROL INPUTS</b>	
Control Input Type	Contact closure (Internal 5V supply) DO NOT ground or apply external voltage
Start Stop Forward/Reverse	Configurable Inputs for 2 or 3 wire control
Jog	Momentary (non-maintained) Input
SW1 SW2 SW3	Configurable Inputs for control of 7 Preset speeds and 2 Accel/Decel times
Enable	Interlock Input to enable drive operation
External Speed Potentiometer	10 K Ohms, 1 Watt
Analog Input (4 to 20mA)	Input Impedance 250 Ohms (Non-Isolated), 10 bit resolution
Analog Input (0 to 10 V DC)	Input Impedance 100 K Ohms (Non-Isolated), 10 bit resolution

**Table A.1 Specifications** (continued)

<b>CONTROL OUTPUTS</b>											
Programmable Output 1	Form A Relay Contact: Resistive Rating 115V AC/ 30V DC, 5A; Inductive Rating 115V AC/ 30V DC, 2A										
Programmable Output 2	Open Collector (Sink): 24V DC, $\pm 20\%$ , 50 mA maximum (User supplied source voltage)										
Analog Output (0 to 10V DC)	Load Impedance $\geq 4,000$ Ohms, 8 bit resolution										
PWM Algorithm	Sine Weighted PWM Output										
Switching Device 3-Phase Output	IGBT Intelligent Power Module										
V/Hz Ratio	Programmable										
Carrier Frequency	Adjustable in 100Hz Increments from 2 kHz to 8 kHz. Output Current Derating applies above 4 kHz.										
DC Boost	Adjustable single point or full custom – Start and Run boost available										
<b>CONTROL FEATURES</b>											
Drive	Bulletin 1305 Drive Rated 200-240 V AC					Bulletin 1305 Drives Rated 380-460 V AC					
	-AA02A	-AA03A	-AA04A	-AA08A	-AA12A	-BA01A	-BA02A	-BA03A	-BA04A	-BA06A	-BA09A
AC Dynamic Braking Torque - Estimated - Actual value will depend on motor characteristics											
W/O External Resistor	100%	100%	100%	50%	50%	100%	100%	100%	50%	50%	20%
With External Resistor	N/A	N/A	N/A	150%	100%	150%	150%	150%	150%	100%	100%
Current Limiting	Trip Free Operation, Co-ordinated for Drive and Motor Protection Programmable from 20% to 150% of Drive Rated Current										
Overload	200%, Fixed by hardware, based on drive rating 150% for 60 seconds										

**Table A.1 Specifications** (continued)

Motor Protection <sup>①</sup>	Electronic Overload Protection. Adjustable from 20% to 115% (Motor FLA)
Overload Pattern #0	Flat response over speed range (no current derating)
Overload Pattern #1	Current derating below 25% of Base Speed
Overload Pattern #2	Current derating below 50% of Base Speed
Accel/Decel Time(s)	0.1 to 3600 Seconds, independently set (2 Accel, 2 Decel)
Preset Speeds	0 to 400 Hz, 7 selections, independently set
Jog Input	0 to 400 Hz
Stopping Modes	4 modes programmable
Ramp to stop	0.1 to 3600 seconds
Coast	Stops all PWM Output
DC Brake to stop	Applies DC Voltage to the Motor for 0 to 150 seconds
S-Curve	Ramps to stop with S-Curve profile
<b>PROTECTIVE FEATURES</b>	
Excessive Temperature	Embedded temperature sensor trips if factory preset level is exceeded <sup>②</sup>
Over/Under Voltage	DC Bus voltage is monitored
Power Ride Through	Minimum ride through 15mS under nominal conditions
Control Ride Through	Minimum ride through is 0.5 Seconds – typical value 2 seconds
Ground Short	Any output short to ground, detected prior to start
Line Voltage Transients	Inherent MOV (varistor) protection
Output Short Circuit	Inherent short circuit protection provided within IPM

<sup>①</sup> See Page 5-12 for NEC and UL information.

<sup>②</sup> Conditions such as ambient temperature, overload, duty cycle, etc. can affect tripping time.

**Table A.1 Specifications** (continued)

<b>PROGRAMMING/COMMUNICATIONS</b>	
Adapters	The maximum current draw of all adapters connected to the drive should not exceed 250 mA
Hand Held Programming	Optional Human Interface Module (HIM can be removed from the Drive)
Type of Annunciation	Parameters displayed in textual form, organized in logical groupings
Type of Display	16 character, 2 line LCD supertwist with backlight
Language Capability	Multiple Languages available
Local Controls	3 versions available ( Digital Pot., Analog Pot. and Blank)
Communication Adapters	Optional adapters provide Remote I/O, or RS232/RS422/RS485/DF1/DH485, or DeviceNet™ capability
<b>MONITORING</b>	
Output Frequency (Hz)	Displayed over the entire range of operation with direction indication
Output Voltage (V)	Selectable as a displayed parameter
Output Current (A)	Selectable as a displayed parameter in % or actual value
Output Power (kW)	Selectable as a displayed parameter in % or actual value
DC Bus Voltage (V)	Selectable as a displayed parameter
Frequency Command (Hz)	Selectable as a displayed parameter
Process Parameter	Any drive variable can be scaled and definable text can be added up to 8 characters
Drive Temperature °C	Selectable as a displayed parameter
Last Fault	The previous 4 faults can be displayed for troubleshooting

## COMMUNICATIONS USING BULLETIN 1203 COMMUNICATION MODULES

Bulletin 1305 drive parameter data can be programmed and displayed using PLC's, SLC's or other logic controllers using an optional Bulletin 1203 Communication Module. The amount of information that can be transferred between the drive and controller is determined by the DIP switch settings on the Communication Module.

Table B.1 illustrates the dip switch settings for Bulletin 1203-GD1 (Remote I/O) communication modules. Dip switch settings for other communication modules will be similar. Refer to the appropriate communication module user manual for details.

**Important:** 1305 drives with firmware revisions FRN1.01 and FRN1.02 are not compatible with Bulletin 1203 Communication Modules. If connected, an error message will be indicated. The red fault status and amber SCANport™ status LED's on the front of the module will flash simultaneously.

SCANport is a trademark of Allen-Bradley Company.

Table B.1 Remote I/O Data Transfer

SW3 Settings	Type of Data Transferred	Rack Space in Words	Reference Information
No. 1	Block transfer of data	1	①
No. 2	Logic commands and Drive Status information	1	See Table B.2 & Table B.3
No. 3	Analog frequency reference	1	②
No. 4	Parameter data via Datalink A	2	See Page 5-54
No. 5	Parameter data via Datalink B	2	See Page 5-54
No. 6	Parameter data via Datalink C	2	See Page 5-54
No. 7	To transfer data via Datalink D	2	See Page 5-54
No. 8	Unused	—	—

① Refer to the Bulletin 1203 Communication Module Block Transfer User Manual.

② To enable the PLC to provide the frequency reference, Logic Bits 12 through 15 must be set to select **[Freq Select 1]** or **[Freq Select 2]** as the frequency reference (refer to Table B.2). The **[Freq Select 1]** or **[Freq Select 2]** parameters must then be set to the adapter number that the communication module is connected to. See Pages 2-24 and 5-25 for additional information on determining the Adapter number and **[Freq Select 1]** and **[Freq Select 2]** selections.

## LOGIC CONTROL DATA

The information in Table B.2 provides the Logic Control information that is sent to the drive through the logic controllers output image table. When using the Bulletin 1203-GD1 communication module, this information is sent to the drive when dip switch No. 2 of SW3 is enabled.

## DRIVE STATUS DATA

The information in Table B.3 provides the Drive Status information that will be sent to the logic controllers input image table from the drive. When using the Bulletin 1203-GD1 communication module this information will be sent to the PLC from the drive when switch No. 2 of SW3 is enabled.

## PARAMETER GROUPS/USER SETTINGS

The information in Table B.4 provides a listing of all drive parameters.

The column entitled “Display Units” are the units that will appear on the Human Interface Module.

Since certain parameters have different resolution than others, a scale factor is required to convert the “Display Units” value to a decimal value that will be displayed in the controller’s I/O image tables. The column marked “Drive Units Scale Factor” is provided to perform this conversion.

## SCALE FACTOR CONVERSION

When **Reading** parameter data in the controller’s input image table, divide this value by the “Drive Units Scale Factor” to determine the “Display Units.”

When **Writing** parameter data from the controller’s output image table to the drive, the value entered into the output image table should be the required “Display Units” value multiplied by the “Drive Units Scale Factor”.

### **“Display Unit” equivalent to Parameter Text Descriptions.**

Some parameters use a text description in the place of numerical “Display Units”. The information in Table B.5 provides the decimal equivalent to the text descriptions.

Table B.2 Logic Control Data

This information will be displayed in the controller's output image table and will be sent to the drive when the appropriate dip switch setting on the Communication Module is enabled.

Logic Bits																Status	Text
15	14	13	12	11	10	9	8	7	6	5	4	3	2	1	0		
															X	Stop	1 = Stop, 0 = Not Stop
															X	Start	1 = Start, 0 = Not Start
													X			Jog	1 = Jog, 0 = Not Jog
											X					Clear Faults	1 = Clear Faults 0 = Not Clear Faults
									X	X						Direction	00 = No Command 10 = Reverse Command 01 = Forward Command 11 = Hold Direction Control
									X							Local	1 = Local Lockout, 0 = Not Local
								X								MOP Increment	1 = Increment, 0 = Not
						X	X									Accel Time	00 = No Commd 10 = Accel Time 2 Commd 01 = Accel Time 1 Commd 11 = Hold Accel Time Ctrl
				X	X											Decel Time	00 = No Commd Time 10 = Decel Time 2 Commd 01 = Decel Time 1 Commd 11 = Hold Time Ctrl
	X	X	X													Reference Select	000 = No Command Select 001 = [Freq Select 1] (Selectable) 010 = [Freq Select 2] (Selectable) 011 = [Preset Freq 3] 100 = [Preset Freq 4] 101 = [Preset Freq 5] 110 = [Preset Freq 6] 111 = [Preset Freq 7]
X																MOP Dec	1 = Decrement, 0 = Not

Table B.3 Drive Status Data

This information will be displayed in the controller's input image table when the appropriate dip switch setting on the Communication Module is enabled.

Logic Bits															Status	Text	
15	14	13	12	11	10	9	8	7	6	5	4	3	2	1			0
															X	Enabled	1 = Enabled, 0 = Not Enabled
															X	Running	1 = Running, 0 = Not Running
														X		Command Direction	1 = Forward, 0 = Reverse
												X				Rotating Direction	1 = Forward, 0 = Reverse
											X					Accel	1 = Accelerating, 0 = Not
										X						Decel	1 = Decelerating, 0 = Not
									X							Alarm	1 = Alarm, 0 = No Alarm
								X								Fault	1 = Faulted, 0 = Not Faulted
							X									At Speed	1 = At Speed, 0 = NOT at Speed
				X	X	X										Local	000 = TB2 Local      100 = Adapter 4 Local 001 = Adapter 1 Local      101 = Adapter 5 Local 010 = Adapter 2 Local      110 = Adapter 6 Local 011 = Adapter 3 Local      111 = No Local Control
X	X	X	X													Frequency Reference	0000 = Freq Select 1      1000 = Freq Select 2 0001 = Preset Freq 1      1001 = Port 1 Adapter 1 0010 = Preset Freq 2      1010 = Port 2 Adapter 2 0011 = Preset Freq 3      1011 = Port 3 Adapter 3 0100 = Preset Freq 4      1100 = Port 4 Adapter 4 0101 = Preset Freq 5      1101 = Port 5 Adapter 5 0110 = Preset Freq 6      1110 = Port 6 Adapter 6 0111 = Preset Freq 7      1111 = Jog Frequency

Table B.4 Parameter Grouping/User Settings

Group	Parameter Name	Parameter Number	Display Units	Drive Units Scale Factor ②	Minimum	Maximum	Factory Setting	User's Setting
Metering	Output Current	54	Amps	100	0.00	Two times drive output current	—	
	Output Voltage	1	Volts	100	0	Maximum Voltage	—	
	Output Power	23	kW	100	0.00	Two times rated drive output power	—	
	DC Bus Voltage	53	Volts	1	0	410 - 230V Drive 815 - 460V Drive	—	
	Output Freq	66	Hz	32767 = Max. Freq	Max. Frequency	Maximum Frequency	—	
	Freq Command	65	Hz	100	0.00	+400.00	0.00	
	MOP Hz	42	Hz	100	0.00	400.00	—	
	Drive Temp	70	Degrees C	1	0	100	—	
	Last Fault	4	Numeric	1	0	Max. Fault Number	—	
	% Output Power	3	%	1	0	200% Drive Rated Power	—	
	% Output Curr	2	%	1	0	200% of Rated Drive Output Current	—	

① Refer to Table B.5 on pages B-13, B-14 and B-15 for the numerical equivalent of the text descriptions

② Refer to page B-2.

Table B.4 Parameter Grouping/User Settings (continued)

Group	Parameter Name	Parameter Number	Display Units	Drive Units Scale Factor ②	Minimum	Maximum	Factory Setting	User's Setting
Set Up	Input Mode	21	Text ①	1	—	—	Three Wire	
	Freq Select 1	5	Text ①	1	—	—	Adapter 1	
	Accel Time 1	7	Seconds	10	0.0	3600.0	10.0	
	Decel Time 1	8	Seconds	10	0.0	3600.0	10.0	
	Base Frequency	17	Hz	1	40	400	60	
	Base Voltage	18	Volts	1	25% of DRV	100% of Drive Rated Volts	Drive Rated Volts	
	Maximum Voltage	20	Volts	1	25% of DRV	110% of Drive Rated Volts	Drive Rated Volts	
	Minimum Freq	16	Hz	1	0	120	0	
	Maximum Freq	19	Hz	1	40	400	60	
	Stop Select	10	Text ①	1	—	—	Ramp	
	Current Limit	36	%	1	20% of DRC	150% of Drive Rated Current (DRC)	150% of DRC	
	Overload Mode	37	Text ①	1	—	—	No Derating	
	Overload Current	38	Amps	100 = DRC	20% of DRC	115% of Drive Rated Current (DRC)	115% of DRC	
	Sec Curr Limit	141	%	1	0% of DRC	150% of Drive Rated Current (DRC)	0% of DRC	
Adaptive I Lim	149	Text ①	1	—	—	Enabled		

① Refer to Table B.6 on pages B-13, B-14 and B-15 for the numerical equivalent of the text descriptions

② Refer to page B-2.

Table B.4 Parameter Grouping/User Settings (continued)

Group	Parameter Name	Parameter Number	Display Units	Drive Units Scale Factor ②	Minimum	Maximum	Factory Setting	User's Setting
Advanced Set Up	Minimum Freq	16	Hz	1	0	120	0	
	Maximum Freq	19	Hz	1	40	400	60	
	Base Frequency	17	Hz	1	40	400	60	
	Base Voltage	18	Volts	1	25% of DRV	100% of Max. Drive Rated Volts	Maximum DRV	
	Break Frequency	49	Hz	1	0	120	30	
	Break Voltage	50	Volts	1	0	50% of Max Drive Rated Volts	Drive Size Dependent	
	Maximum Voltage	20	Volts	1	25% of DRV	110% of Max. Drive Rated Volts	Maximum DRV	
	DC Boost Select	9	Text ①	1	—	—	Break Point	
	Start Boost	48	Volts	1	0	25% of Max. Drive Rated Volts	Drive Size Dependent	
	Run Boost	83	Volts	1	0	25% of Max. Drive Rated Volt	0	
	PWM Frequency	45	kHz	10	2.0	8.0	4.0	
	Analog Invert	84	Text ①	1	—	—	Disabled	
	4–20 mA Loss Sel	81	Text ①	1	—	—	Stop/Fault	
	Stop Select	10	Text ①	1	—	—	Ramp	
	DC Hold Time	12	Seconds	100	0.0	150.0	0.0	
	DC Hold Volts	13	Volts	1	0	25% of Max. Drive Rated Volts	0	
DB Enable	11	Text ①	1	—	—	Disabled		
Motor Type	41	Text ①	1	—	—	Induc/Reluc		
Compensation	52	Text ①	1	—	—	Comp		

① Refer to Table B.1 on pages B-13, B-14 and B-15 for the numerical equivalent of the text descriptions.

② Refer to page B-2.

Table B.4 Parameter Grouping/User Settings (continued)

Group	Parameter Name	Parameter Number	Display Units	Drive Units Scale Factor ②	Minimum	Maximum	Factory Setting	User's Setting
Frequency Set	Freq Select 1	5	Text ①	1	—	—	Adapter 1	
	Freq Select 2	6	Text ①	1	—	—	Remote Pot	
	Jog Frequency	24	Hz	100	0.0	400.0	10.0	
	Prst/2nd Accel	26	Text ①	1	—	—	Preset	
	Upper Presets	72	Text ①	1	—	—	Disabled	
	Accel Time 2	30	Seconds	10	0.0	3600.0	5.0	
	Decel Time 2	31	Seconds	10	0.0	3600.0	5.0	
	Preset Freq 1	27	Hz	100	0.0	400.0	10.0	
	Preset Freq 2	28	Hz	100	0.0	400.0	20.0	
	Preset Freq 3	29	Hz	100	0.0	400.0	30.0	
	Preset Freq 4	73	Hz	100	0.0	400.0	40.0	
	Preset Freq 5	74	Hz	100	0.0	400.0	50.0	
	Preset Freq 6	75	Hz	100	0.0	400.0	60.0	
	Preset Freq 7	76	Hz	100	0.0	400.0	0.0	
	Skip Freq 1	32	Hz	1	0	400	400	
	Skip Freq 2	33	Hz	1	0	400	400	
	Skip Freq 3	34	Hz	1	0	400	400	
	Skip Freq Band	35	Hz	1	0	15	0	
	MOP Increment	22	Hz/Second	1	0.00	255.00	1.00	
	Analog Filter	144	Text ①	1	—	—	100%	

① Refer to Table B.7 on pages B-13, B-14 and B-15 for the numerical equivalent of the text descriptions.

② Refer to page B-2.

Table B.4 Parameter Grouping/User Settings (continued)

Group	Parameter Name	Parameter Number	Display Units	Drive Units Scale Factor ②	Minimum	Maximum	Factory Setting	User's Setting
Feature Select	Run On Power Up	14	Text ①	1	—	—	Disabled	
	Reset/Run Tries	85	Numeric	1	0	9	0	
	Reset/Run Time	15	Seconds	100	0.5	30.0	1.0	
	S Curve Enable	57	Text ①	1	—	—	Disabled	
	S Curve Time	56	Seconds	10	0.0	300.0	0.0	
	Language	47	Text ①	1	—	—	Appropriate Lang.	
	Cable Length	143	Text ①	1	—	—	Short	
	Rated Slip	146	Hz	10	0.0	5.0	2.0	
	Slip Comp Adder	148	Hz	100	0.00	5.00	—	
	IR Comp %	147	%	1	0%	150%	Drive Size Depend.	
Output Config	Output 1 Config	90	Text ①	1	—	—	Faulted	
	Output 2 Config	91	Text ①	1	—	—	Running	
	Analog Out Sel	25	Text ①	1	—	—	Frequency	
	Above Freq Val	77	Hz	1	0	400	0	
	Above Curr Val	142	%	1	0	150% of Drive Rated Current (DRC)	0	
Faults	Fault Buffer 0	86	Numeric	1	—	—	—	
	Fault Buffer 1	87	Numeric	1	—	—	—	
	Fault Buffer 2	88	Numeric	1	—	—	—	
	Fault Buffer 3	89	Numeric	1	—	—	—	
	Clear Fault	51	Text ①	1	—	—	Ready	
	Cur Lim Trip En	82	Text ①	1	—	—	Default Run	
	Line Loss Fault	40	Text ①	1	—	—	F03 Enable	
	Flt Clear Mode	39	Text ①	1	—	—	Enabled	

① Refer to Table B.1 on pages B-13, B-14 and B-15 for the numerical equivalent of the text descriptions.

② Refer to page B-2.

Table B.4 Parameter Grouping/User Settings (continued)

Group	Parameter Name	Parameter Number	Display Units	Drive Units Scale Factor ②	Minimum	Maximum	Factory Setting	User's Setting
Diagnostics	Drive Command	58	Byte	—	—	—	—	
	Drive Status	59	Text ①	—	—	—	—	
	Drive Alarm	60	Byte	—	—	—	—	
	Input Status	55	Byte	—	—	—	—	
	Freq Source	62	Text ①	1	—	—	—	
	Freq Command	65	Hz	100	0.00	400.00	0.00	
	Drive Direction	69	Text ①	1	—	—	Forward	
	Motor Mode	43	Text ①	1	—	—	—	
	Power Mode	44	Text ①	1	—	—	—	
	Drive Type	61	Numeric	1	—	—	—	
	Firmware Ver.	71	Numeric	1	—	—	—	
	Output Pulses	67	Cycles	256 = 1 rev	0	65535	—	
	Drive Temp	70	Degrees C	1	0	100	—	
	Set Defaults	64	Text ①	1	—	—	Ready	
Masks	Logic Mask	92	Byte	—	—	—	01111111	
	Direction Mask	94	Byte	—	—	—	01111111	
	Start Mask	95	Byte	—	—	—	01111111	
	Jog Mask	96	Byte	—	—	—	01111111	
	Reference Mask	97	Byte	—	—	—	01111111	
	Accel Mask	98	Byte	—	—	—	01111111	
	Decel Mask	99	Byte	—	—	—	01111111	
	Fault Mask	100	Byte	—	—	—	01111111	
	MOP Mask	101	Byte	—	—	—	01111111	
Local Mask	93	Byte	—	—	—	01111111		

① Refer to Table B.1 on pages B-13, B-14 and B-15 for the numerical equivalent of the text descriptions.

② Refer to page B-2.

Table B.4 Parameter Grouping/User Settings (continued)

Group	Parameter Name	Parameter No.	Display Units	DU Scale Factor ①	Minimum	Maximum	Factory Setting	Setting
Owners	Stop Owner	102	Byte	—	—	—	—	
	Direction Owner	103	Byte	—	—	—	—	
	Start Owner	104	Byte	—	—	—	—	
	Jog Owner	105	Byte	—	—	—	—	
	Reference Owner	106	Byte	—	—	—	—	
	Accel Owner	107	Byte	—	—	—	—	
	Decel Owner	108	Byte	—	—	—	—	
	Fault Owner	109	Byte	—	—	—	—	
	MOP Owner	110	Byte	—	—	—	—	
	Local Owner	137	Byte	—	—	—	—	
Adapter I/O	Data In A1	111	Numeric	1	0	149	0	
	Data In A2	112	Numeric	1	0	149	0	
	Data In B1	113	Numeric	1	0	149	0	
	Data In B2	114	Numeric	1	0	149	0	
	Data In C1	115	Numeric	1	0	149	0	
	Data In C2	116	Numeric	1	0	149	0	
	Data In D1	117	Numeric	1	0	149	0	
	Data In D2	118	Numeric	1	0	149	0	
	Data Out A1	119	Numeric	1	1	149	1	
	Data Out A2	120	Numeric	1	1	149	1	
	Data Out B1	121	Numeric	1	1	149	1	
	Data Out B2	122	Numeric	1	1	149	1	
	Data Out C1	123	Numeric	1	1	149	1	
	Data Out C2	124	Numeric	1	1	149	1	
Data Out D1	125	Numeric	1	1	149	1		
Data Out D2	126	Numeric	1	1	149	1		

① Refer to page B-2.

Table B.4 Parameter Grouping/User Settings (continued)

Group	Parameter Name	Parameter Number	Display Units	Drive Units Scale Factor ②	Minimum	Maximum	Factory Setting	User's Setting
Process Display	Process Par	127	Numeric	1	1	149	1	
	Process Scale	128	Numeric	100	-327.68	+327.67	+1.00	
	Process Text 1	129	ASCII Text	—	—	—	?	
	Process Text 2	130	ASCII Text	—	—	—	—	
	Process Text 3	131	ASCII Text	—	—	—	—	
	Process Text 4	132	ASCII Text	—	—	—	—	
	Process Text 5	133	ASCII Text	—	—	—	—	
	Process Text 6	134	ASCII Text	—	—	—	—	
	Process Text 7	135	ASCII Text	—	—	—	—	
Process Text 8	136	ASCII Text	—	—	—	—		

① Refer to Table B.1 on pages B-13, B-14 and B-15 for the numerical equivalent of the text descriptions.

② Refer to page B-2.

Table B.1 “Display Unit” Equivalent to Parameter Text Descriptions

Parameter Number	Parameter Name	Text	Display Unit
5	Freq Select 1	“Remote Pot”	1
6	Freq Select 2	“0-10 Volt”	2
62	Freq Source	“4-20 mA”	3
		“MOP”	4
		“Adapter 1”	5
		“Adapter 2 ”	6
		“Adapter 3”	7
		“Adapter 4”	8
		“Adapter 5”	9
		“Adapter 6”	10
		“Preset 1”	11
		“Preset 2”	12
		“Preset 3”	13
		“Preset 4”	14
		“Preset 5”	15
		“Preset 6”	16
		“Preset 7”	17
		“Jog Sel ” <sup>①</sup>	18

Parameter No.	Parameter Name	Text	Display Unit
9	DC Boost Select	“Fan Sel #1”	0
		“Fan Sel #2”	1
		“No Boost”	2
		“6 volts”	3
		“12 volts”	4
		“18 volts”	5
		“24 volts”	6
		“30 volts”	7
		“36 volts”	8
		“42 volts”	9
		“48 volts”	10
		“Break Point”	11
“Run Boost”	12		
10	Stop Select	“Coast”	0
		“DC Brake”	1
		“Ramp”	2
		“S-Curve”	3

① Valid for parameter (62) [Freq Source] only.

Table B.1 “Display Unit” Equivalent to Parameter Text Descriptions (continued)

Parameter-Number	Parameter Name	Text	Display Unit
11	DB Enabled	“Disabled”	0
		“Enabled”	1
14	Run On Power Up	Disabled	0
		Enabled	1
21	Input Mode	“Three Wire”	0
		“Run Fwd/Rev”	1
		“3 W/2nd Acc”	2
		“Run F/R 2nd A”	3
		“3 Wire/MOP”	4
		“Run F/R MOP”	5
25	Analog Out Sel	“Frequency”	0
		“Current”	1
		“BusVolts”	2
		“Power”	3
		“Output Volts”	4
26	Preset/2nd Accel	“Preset”	0
		“2nd Accel”	1
37	Overload Mode	“No Derating”	0
		“Min Derate”	1
		“Max Derate”	2
39	Fault Clear Mode	Disabled	0
		Enabled	1

Parameter No.	Parameter Name	Text	Display Unit
40	Line Loss Fault	“F03 Enable”	0
		“Uvolt Run”	1
41	Motor Type	“Induc/Reluc”	0
		“Sync PM”	1
43	Motor Mode	“Invalid”	0
		“Zero Mode”	1
		“Accel Mode”	2
		“At Hz Mode”	3
		“Decel Mode”	4
		“Coast Mode”	5
		“Braking Mode”	6
		“Faulted Mode”	7
44	Power Mode	“Invalid”	0
		“First Mode”	1
		“Charge Mode”	2
		“Wait Mode”	3
		“Test Mode”	4
		“Line Loss Mode”	5
		“Idle Mode”	6
		“Active Mode”	7
“Braking Mode”	8		
“Faulted Mode”	9		

Table B.1 “Display Unit” Equivalent to Parameter Text Descriptions (continued)

Parameter No.	Parameter Name	Text	Display Unit
47	Language	“English”	0
		“Alternate Language”	1
51	Clear Fault	“Ready”	0
		“Clear Fault”	1
52	Compensation	“No Comp.”	0
		“Comp.”	1
57	S-Curve Enable	Disabled	0
		Enabled	1
64	Set Defaults	“Ready”	0
		“Store to EE”	1
		“Recl frm EE”	2
		“Default Init”	3
69	Drive Direction	“Forward”	0
		“Reverse”	1
72	Upper Presets	Disabled	0
		Enabled	1
81	4-20mA Loss Sel	“Min/Alarm”	0
		“Stop/Fault”	1
		“Hold/Alarm”	2
		“Max/Alarm”	3
		“Pre1/Alarm”	4
82	Curr Lim Trip En	“Default Run”	0
		“Trip @ 1 Lmt”	1
84	Analog Invert	Disabled	0
		Enabled	1
90	Output Config 1	“At Speed”	0
91	Output Config 2	“Above Freq”	1
		“Running”	2
		“Faulted”	3
		“Alarm”	4
143	Cable Length	“Short”	0
		“Long”	1
144	Analog Filter	0%	0
		25%	1
		50%	2
		75%	3
149	Adaptive I Lim	Disabled	0
		Enabled	1

**This Page Intentionally Left Blank.**

**Table C.1 Accessories**

Bulletin 1201 Descriptions	Use With	IP30 (NEMA Type 1) Cat. No.	IP66 NEMA Type 12 (ULType 4X Indoor) Cat. No.	IP30 NEMA Type 1/12 (Enhanced) Cat. No.	Hand Held) (Enhanced) Cat. No.
Door Mount Bezel Kit	Bulletin 1305 Drives	1201-DMA	–	–	–
Blank Cover		1201-HAB	–	–	–
Human Interface Module – Programmer Only		1201-HAP	1201-HJP	1201-HJPE	1201-HHPE
Human Interface Module – Analog Speed Potentiometer		1201-HA1	–	–	–
Human Interface Module – Programmer/Run Time Functions		–	–	1201-HJ3E	1201-HH3E
Human Interface Module – Digital Up–Down Speed Control		1201-HA2	1201-HJ2	–	–
Bulletin 1202 Descriptions	Use With	Cat. No.	Cat. No.	Cat. No.	Cat. No.
Communication Cable (Male-Male) for Port 2 0.33 Meter (1.1 Feet) 1 Meter (3.3 Feet) 3 Meter (9.8 Feet) 9 Meter (29.5 Feet)	Human Interface Module and Communications Modules	1202-C03 1202-C10 1202-C30 1202-C90	–	–	–
Communication Cable (Male-Female) for Port 1 0.33 Meter (1.1 Feet) 1 Meter (3.3 Feet) 3 Meter (9.8 Feet) 9 Meter (29.5 Feet)	Human Interface Module and Communications Modules	1202-H03 1202-H10 1202-H30 1202-H90	–	–	–
Bulletin 1203 Descriptions	Use With	Cat. No.	Cat. No.	Cat. No.	Cat. No.
Single Point Remote I/O Communication Module ①	Bulletin 1305 Drives	1203-GD1/GK1	–	–	–
RS232/RS422/RS485/DF1/DH485 Serial Communication Module ①		1203-GD2/GK2	–	–	–
DeviceNet™ Communication Module ②		1203-GK5	–	–	–
2 Port Splitter 4 Port Splitter		1203-SG2 1203-SG4	–	–	–
SLC/SCANport Module		1203-SM1	–	–	–
Flex I/O SCANport Terminal Base Flex I/O SCANport Module		1203-FB1 1203-FM1	–	–	–

① Separately powered AC/DC.

② Separately powered DC only.

Table C.2 Accessories

Accessory	Specifications
<b>Line Reactor</b>	Iron core, 3% Impedance, 600V, Class H insulation, 115°C rise, copper wound, 50/60 Hz, terminal blocks, UL, CSA
<b>Isolation Transformer</b>	230V/230V or 460V/460V, Delta primary/Wye secondary, Class H insulation, 150°C rise, aluminum wound, 60 Hz, ± 5% taps, (1) N.C. thermostat per coil, UL, CSA
<b>Terminators</b>	NEMA 4, 460V units – Refer to “Motor Lead Lengths” for proper selection.

Drive Out. Ratings		Input Line Reactors		Isolation Transformer	Terminators
HP	kW	Open Style	NEMA Type 1	NEMA Type 1	NEMA Type 4
<b>230V AC</b>					
0.5	0.37	1321-3R4-B	1321-3RA4-B	1321-3T003-AA	—
0.75	0.55	1321-3R4-A	1321-3RA4-A	1321-3T003-AA	—
1	0.75	1321-3R4-A	1321-3RA4-A	1321-3T005-AA	—
2	1.5	1321-3R8-A	1321-3RA8-A	1321-3T005-AA	—
3	2.2	1321-3R12-A	1321-3RA12-A	1321-3T005-AA	—
<b>460V AC</b>					
0.5	0.37	1321-3R2-B	1321-3RA2-B	1321-3T003-BB	—
0.75	0.55	1321-3R2-A	1321-3RA2-A	1321-3T003-BB	—
1	0.75	1321-3R2-A	1321-3RA2-A	1321-3T005-BB	1204-TFA1
2	1.5	1321-3R4-B	1321-3RA4-B	1321-3T005-BB	1204-TFA1 or TFB2
3①	2.2	1321-3R4-B	1321-3RA4-B	1321-3T005-BB	1204-TFA1 or TFB2
3	2.2	1321-3R8-B	1321-3RA8-B	1321-3T005-BB	1204-TFA1 or TFB2
5①	4.0	1321-3R8-B	1321-3RA8-B	1321-3T005-BB	1204-TFA1 or TFB2
5	4.0	1321-3R12-B	1321-3RA12-B	1321-3T007-BB	1204-TFA1

Drive Output Ratings		Dynamic Brake Kits ②
HP	kW	(Kits <i>must not</i> be wired in parallel)
<b>230V AC</b>		
0.5-1	0.37-0.75	Not Required
2-3	1.5-2.2	1305-KAA12
<b>460V AC</b>		
0.5-1	0.37-0.75	1305-KBA03
2-3	1.5-2.2	1305-KBA06
5	4.0	1305-KBA09 ③

CE Conformance Filters	RFI Filters, Kits, and Metal Conduit Plates Required to Meet CE Directives	
Filter (RFB) Metal Plate Kit (MP)	0.5 – 0.75 HP (230V)	1305-RFB-05-A 1305-MP-05-A
	1 HP (230V)	1305-RFB-05-A 1305-MP-06-A
	2 HP (230V), 0.5 – 3 HP (460V)	1305-RFB-08-B 1305-MP-08-B
	3 HP (230V), 5 HP (460V)	1305-RFB-12-C 1305-MP-12-C

Note: Spare plastic parts are available – contact factory.

① Input reactor only.

② **[DB Enable]** should be set to “Enable” when applying external dynamic brake kits.

③ For use with Series C or B Drives only. DO NOT use with Series A Drives.

## EMC DIRECTIVE

This apparatus is tested to meet Council Directive 89/336 Electromagnetic Compatibility (EMC) using a technical construction file and the following standards, in whole or in part:

- EN 50081-1, -2 – General Emission Standard
- EN 50082-1, -2 – General Immunity Standard

**Table D.1 EMC Directives**

<b>Marked for all applicable directives</b>		
<b>Emissions</b>	EN55 011/CISPR 11 Level B	
<b>Immunity</b>	EN50 082-1:1992 (IEC 801-2, IEC 801-3, IEC 801-4) EN50 082-2:1995 (EN 61000-4-2, ENV 50140/50204, EN 61000-4-4, ENV 50141, EN 61000-4-8, IEC 801-6)	

**Important:** The conformity of the drive and filter to any standard does not guarantee that the entire installation will conform. Many other factors can influence the total installation and only direct measurements can verify total conformity.

## REQUIREMENTS FOR CONFORMING INSTALLATION

The following six items **are required** for CE conformance:

1. CE marked product in NEMA Type 1 (IP30) configuration.
2. Filter and Metal Plate Kit catalog numbers are listed in Table D.2 on the following page. One Filter and one Metal Plate Kit are required. The metal bonding plate **MUST** be inserted and bonded to the drive heatsink.
3. Grounding as shown on page D-3. The Green & Yellow ground wire connects to the TB1 GRD terminals and the shield terminates at the compact strain relief connector with double saddle clamp (see item 5).
4. Maximum cable length (drive to motor) of 75 meters (250 feet). For applications greater than 9 meters (30 feet), refer to recommendations tabulated in "Motor Lead Lengths" (see Chapter 2).
5. Input power (source to filter) and output power (drive to motor) wiring must be in braided shielded cable with a coverage of 75% or better, metal conduit or other with equivalent or better attenuation, mounted with appropriate connectors. For shielded cable it is recommended to use a compact strain relief connector with a double saddle clamp for filter and drive input and a compact strain relief connector with EMI protection for motor output.
6. Control (I/O) and signal wiring must be in shielded cable connected to the drive with a compact strain relief connector with EMI protection.

## FILTER

**Table D.2 Filter and Metal Plate Kit Selection**

Filter	Metal Plate Kit	AC Drive Type
1305-RFB-5-A	1305-MP-05-A	1305-AA02 1305-AA03
	1305-MP-06-A	1305-AA04
1305-RFB-8-B	1305-MP-08-B	1305-AA08
		1305-BA01
		1305-BA02
		1305-BA03
		1305-BA04
1305-BA06		
1305-RFB-12-C	1305-MP-12-C	1305-AA12 1305-BA09

### RFI Filter Installation

**Important:** Refer to the instructions supplied with the filter for details.

The RFI filter must be connected between the incoming AC supply line and the drive input terminal.

### RFI Filter Leakage Current

The RFI filter may cause ground leakage currents. Therefore a solid ground connection must be provided.



**ATTENTION:** To guard against possible equipment damage, RFI filters can only be used with AC supplies that are nominally balanced with respect to ground. In some installations, three-phase supplies are occasionally connected in a 3-wire configuration with one phase grounded (Grounded Delta). The filter must not be used in Grounded Delta supplies, nor should they be used in single-phase input applications.

## ELECTRICAL CONFIGURATION

Figure D.1 Electrical Configuration

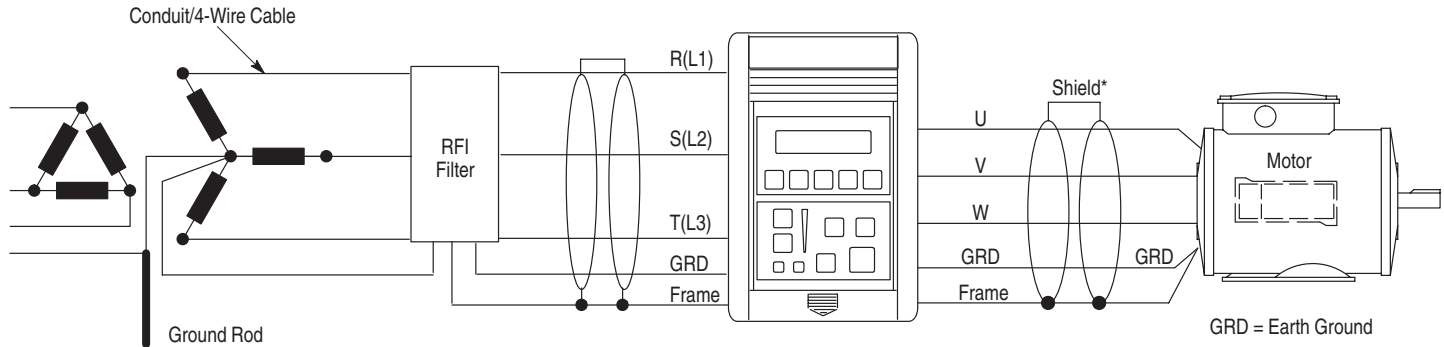

## GROUNDING

### RFI Filter Grounding

**Important:** Shield must be terminated in cable clamp to frame.  
Ground wire must be connected to GRD terminal.

**Important:** For use with a 1305 drive with metal conduit entry panel (frame). Using an RFI filter may result in relatively high ground leakage currents. Therefore, the filter must be permanently installed and solidly grounded to the supply neutral. Grounding must not rely on flexible cables and should not include any form of plug or socket that would permit inadvertent disconnection. The integrity of this connection should be periodically checked. Refer to the instruction manual for RFI filters for CE compliance and for proper installation instructions.

## MECHANICAL CONFIGURATION

Figure D.2 Mechanical Configuration

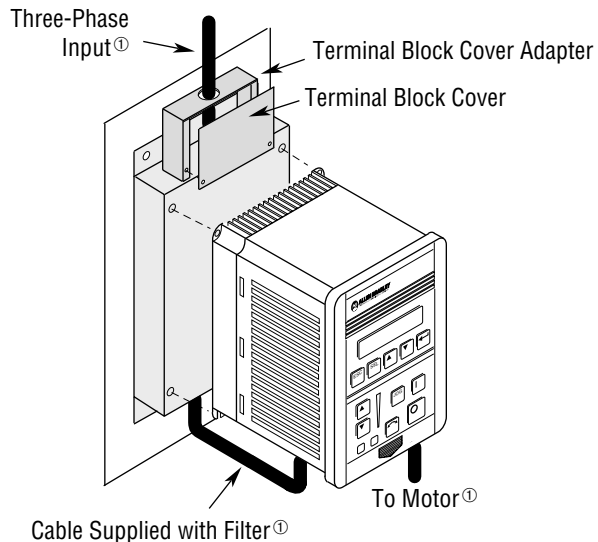

<sup>①</sup> Input power (source to filter) and output power (filter to drive and drive to motor) wiring must be in conduit or have shielding/armor with equivalent attenuation. Shielding/armor must be bonded to the metal conduit panel. See requirements 5 and 6 on page D-1 for details.

Figure D.3 Required Knockout Assignments

### Frame A

(1305-AA02A, AA03A, AA04A)

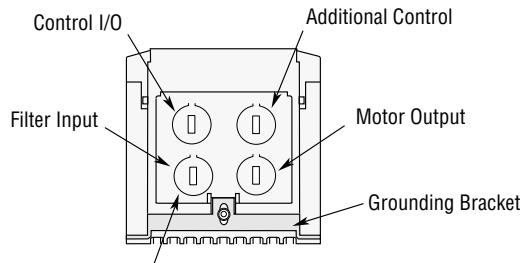

18.6 (0.73) - 4 Plcs.

### Frames B and C

(1305-AA08A, AA12A, BA01A, BA02A, BA03A, BA04A, BA06A, BA09A)

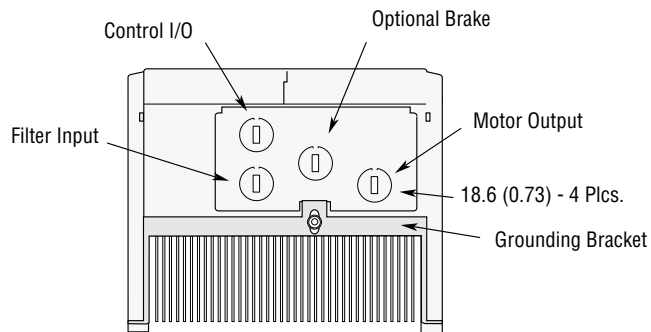

## A

Accel/Decel Control, 2-18, 5-9, 5-26, 5-29, 5-30  
Accessories, C-1, D-2  
Adapters, 2-23  
Ambient Temperature, A-3  
Analog Input  
    0-10V, A-3  
    4-20mA, 5-21, A-3  
Analog Invert, 5-21  
Analog Output, 5-38, A-4  
Auto Restart, 5-32

## B

Block Diagram, A-1

## C

Carrier Frequency, 5-20, A-4  
Catalog Number Description, 1-5  
Choose Mode, 3-5, 3-6  
Clearing Faults, 5-39, 5-41, 6-1  
Control Panel  
    Analog Speed Potentiometer, 3-3  
    Direction Indicators (LEDs), 3-3  
    Speed Indicator, 3-3

## Control Panel Keys

    Change Direction, 3-3  
    Increment/Decrement, 3-3  
    Jog, 3-2  
    Start, 3-2  
    Stop, 3-2  
Control Status Mode, 3-5, 3-15  
Conventions Used in Manual, 1-3  
Current Limiting, 5-12, 5-13, 5-39  
Current Rating, 1-5  
Custom Volts/Hertz Patterns, 5-16, 5-17, 5-18

## D

DC Brake to Stop, 5-11, 5-23  
DC Charge Indicator, 1-2  
DC Hold Volts, 5-23  
Diagnostics Group, 5-42  
Dimensions, 2-2  
Display Mode, 3-5, 3-7  
Display Panel Keys  
    Enter, 3-2  
    Escape, 3-2  
    Increment/Decrement, 3-2  
    Select, 3-2

Distances between Devices, 2-1, 2-13, 2-16, 2-23, 2-24  
Drive Temperature, 5-7, 5-46

## E

EEProm Mode, 3-5, 3-11  
ESD, Electrostatic Discharge, 1-1

## F

Fan/Pump Volts/Hz Patterns, 5-18  
Fault Buffer History, 5-39  
Faults  
    Diag C Lim Fault, 6-3, 6-4  
    Drive Reset Fault, 6-3  
    EEProm Fault, 6-3  
    Hertz Err Fault, 6-3  
    Hertz Set Fault, 6-3  
    IPM Current Fault, 6-4  
    IPM Overtemp Fault, 6-4  
    Max Retries Fault, 6-4  
    Motor Mode Fault, 6-5  
    Motor Stall Fault, 6-5  
    Neg Slope Fault, 6-5  
    Op Error Fault, 6-5  
    Open Pot Fault, 6-5  
    Overcurrent Fault, 6-6

Overload Fault, 6-6  
Overspeed Fault, 6-6  
Overtemp Fault, 6-6  
Overvolt Fault, 6-6  
Phase U Fault, 6-6  
Phase V Fault, 6-6  
Phase W Fault, 6-6  
Power Loss Fault, 6-7  
Power Mode Fault, 6-7  
Reprogram Fault, 6-7  
Run Boost Fault, 6-7  
Serial Fault, 6-7  
Undervolt Fault, 6-8  
UV Short Fault, 6-8  
UW Short Fault, 6-8  
VW Short Fault, 6-8  
Firmware Compatibility, 1-4  
Frequency Select, 5-25, 5-29, 5-30  
Fusing, AC Input, 2-6

## G

Group Level, 3-6

## H

HIM  
    Control Panel, 3-1

Display Panel, 3-1  
Installation, 3-4  
Key Descriptions, 3-2  
Removal, 3-4

#### HIM Modes

Control Status, 3-5, 3-15  
Display, 3-5, 3-7  
EEProm, 3-5, 3-11  
Password, 3-5, 3-17  
Process, 3-5, 3-10  
Program, 3-5, 3-7  
Search, 3-5, 3-14

#### Human Interface Module

*See also* HIM  
Key Descriptions, 3-2  
Removal, 3-4

Human Interface Module (HIM), Description, 3-1

## I

Input Mode Selection, 2-17  
Input Power Conditioning, 2-6  
Isolation Transformer, 2-6

## J

Jog, 5-26, 5-48

## L

Language, 1-5, 5-34  
LEDs  
    Direction Indicators, 3-3  
    Speed Indicator, 3-3  
Levels  
    Group, 3-6  
    Mode, 3-6  
    Operator, 3-6  
    Parameter, 3-6  
Line Reactor, 2-6  
Low Line Operation, 5-40, 5-41

## M

Min/Max Frequencies, 5-11  
Mode Level, 3-6  
Modes  
    *See also* HIM Modes  
    Choose, 3-5, 3-6  
MOP Function, 2-18, 5-6, 5-28  
Mounting, 2-1

## N

Nameplate Location, 1-4

## O

Operator Level, 3-6  
Output Contacts, 5-37, 5-38, A-5  
Output Disconnection, 2-6  
Output Ratings, 1-5, A-2  
Overload Protection, 5-12

## P

Parameter Level, 3-6  
Parameters  
    % Output Current, 5-7  
    % Output Power, 5-7  
    4-20mA Loss Sel, 5-21  
    Above Curr Val, 5-38  
    Above Freq Val, 5-38  
    Accel Mask, 5-48  
    Accel Owner, 5-52  
    Accel Time 1, 5-9  
    Accel Time 2, 5-26  
    Adapter I/O, 5-54  
    Adaptive I Lim, 5-14  
    Advanced Setup Group, 5-15  
    Analog Filter, 5-31  
    Analog Invert, 5-21  
    Analog Out Sel, 5-38  
    Base Frequency, 5-10, 5-15

Base Voltage, 5-10, 5-16  
Break Frequency, 5-16  
Break Voltage, 5-17  
Cable Length, 5-35  
Clear Fault, 5-39  
Compensation, 5-24  
Current Lim Trip En, 5-40  
Current Limit, 5-11  
Data In A1, 5-54  
Data Out A1, 5-54  
DB Enable, 5-23  
DC Boost Select, 5-18  
DC Bus Voltage, 5-5  
DC Hold Time, 5-22  
DC Hold Volts, 5-23  
Decel Mask, 5-48  
Decel Owner, 5-52  
Decel Time 1, 5-9  
Decel Time 2, 5-27  
Diagnostics Group, 5-42  
Direction Mask, 5-47  
Direction Owner, 5-50  
Drive Alarm, 5-44  
Drive Command, 5-42  
Drive Direction, 5-45  
Drive Status, 5-43  
Drive Temp, 5-7, 5-46

- Drive Type, 5-46
  - Fault Buffer 0-3, 5-39
  - Fault Clear Mode, 5-41
  - Fault Mask, 5-49
  - Fault Owner, 5-52
  - Faults Group, 5-39
  - Feature Select, 5-32
  - Firmware Ver, 5-46
  - Freq Command, 5-6, 5-45
  - Freq Select 1, 5-8, 5-25
  - Freq Select 2, 5-25
  - Freq Selection, 5-29
  - Freq Source, 5-45
  - Frequency Set Group, 5-25
  - Input Mode, 5-8
  - Input Status, 5-44
  - IR Comp %, 5-36
  - Jog Frequency, 5-26
  - Jog Mask, 5-48
  - Jog Owner, 5-51
  - Language, 5-34
  - Last Fault, 5-7
  - Line Loss Fault, 5-40
  - Local Mask, 5-49
  - Local Owner, 5-53
  - Logic Masks, 5-47
  - Masks Group, 5-47
  - Maximum Frequency, 5-15
  - Maximum Voltage, 5-10, 5-17
  - Minimum Frequency, 5-10, 5-15
  - MOP Hertz, 5-6
  - MOP Increment, 5-28
  - MOP Mask, 5-49
  - MOP Owner, 5-53
  - Motor Mode, 5-45
  - Motor Type, 5-23
  - Output 1 Config, 5-37
  - Output 2 Config, 5-37
  - Output Configuration Group, 5-37
  - Output Current, 5-5
  - Output Frequency, 5-6
  - Output Power, 5-5
  - Output Pulses, 5-46
  - Output Voltage, 5-5
  - Overload Current, 5-12
  - Overload Mode, 5-12
  - Owners, 5-50
  - Power Mode, 5-46
  - Preset Freq 1-7, 5-27
  - Process 1 Par, 5-55
  - Process 1 Scale, 5-55
  - Process Display Group, 5-55, 5-56
  - Process Txt 1-8, 5-55
  - Prst/2nd Accel, 5-26
  - PWM Frequency, 5-20
  - Rated Slip, 5-35
  - Reference Mask, 5-48
  - Reference Owner, 5-52
  - Reset/Run Time, 5-33
  - Reset/Run Tries, 5-32
  - Run Boost, 5-19
  - Run On Power Up, 5-32
  - S Curve Enable, 5-33
  - S Curve Time, 5-34
  - Sec Current Limit, 5-13
  - Set Defaults, 5-46
  - Setup Group, 5-8
  - Skip Frequency Band, 5-28
  - Skip Frequency Group 1-3, 5-27
  - Slip Comp Adder, 5-36
  - Start Boost, 5-19
  - Start Mask, 5-48
  - Start Owner, 5-51
  - Stop Owner, 5-50
  - Stop Select, 5-11, 5-22
  - Upper Presets, 5-26
  - Password Mode, 3-5, 3-17
  - Potentiometer Wiring, 2-21
  - Power Dissipation, A-2
  - Preset Frequencies, 5-26, 5-27, 5-29, 5-30
  - Process Display, 5-55, 5-56
  - Process Mode, 3-5, 3-10
  - Program Mode, 3-5, 3-7
  - Programming
    - Function Index, 5-1
    - Using a HIM, 5-1
  - Programming Steps, 5-2, 5-4
- ## R
- Reverse, 2-18
- ## S
- S-Curve, 5-33, 5-34
  - Search Mode, 3-5, 3-14
  - Set Defaults, 5-46
  - Skip Frequencies, 5-27
  - Specifications
    - Control, A-3
    - Environment, A-3
    - Input/Output Ratings, A-2
    - Protection, A-5
  - Start-Up, 4-1
    - Procedure, 4-1
  - Status Display, 3-5
  - Stopping, 5-11, 5-22

Storage Temperature, A-3  
Switch Settings  
    Accel/Decel Selection, 5-30  
    Frequency Selection, 5-29

**T**

Three Wire (3w) Control, 2-18  
Troubleshooting, 6-1  
Two Wire Control, 2-17

**V**

Vibration, A-3  
Voltage Boost, 5-18, 5-19  
Voltage Rating, 1-5

**W**

Wiring, Control and Signal, 2-17, 2-18



**[www.rockwellautomation.com](http://www.rockwellautomation.com)**

---

**Power, Control and Information Solutions Headquarters**

Americas: Rockwell Automation, 1201 South Second Street, Milwaukee, WI 53204-2496 USA, Tel: (1) 414.382.2000, Fax: (1) 414.382.4444

Europe/Middle East/Africa: Rockwell Automation, Vorstlaan/Boulevard du Souverain 36, 1170 Brussels, Belgium, Tel: (32) 2 663 0600, Fax: (32) 2 663 0640

Asia Pacific: Rockwell Automation, Level 14, Core F, Cyberport 3, 100 Cyberport Road, Hong Kong, Tel: (852) 2887 4788, Fax: (852) 2508 1846

Publication 1305-5.2 – September, 1998

Supersedes July, 1996

P/N 40052-379-01 (01)

Copyright 1998 Rockwell Automation, Inc. All rights reserved. Printed in USA