

[efesotomasyon.com](http://efesotomasyon.com)



Catalog

ABB general machinery drives  
ACS350, 0.37 to 22 kW / 0.5 to 30 hp

[efesotomasyon.com](http://efesotomasyon.com)

Power and productivity  
for a better world™





# Two ways to select your drive

**Choice 1:** Simply contact your local ABB drives sales office (see page 19) and let them know what you want. Use page 3 as a reference section for more information.

OR

**Choice 2:** Build up your own ordering code using the simple 7-step approach below. Each step is accompanied by a reference to a page that is filled with useful information.

**Type code structure:**

ACS350 - 01E - 02A4 - 2 + A123

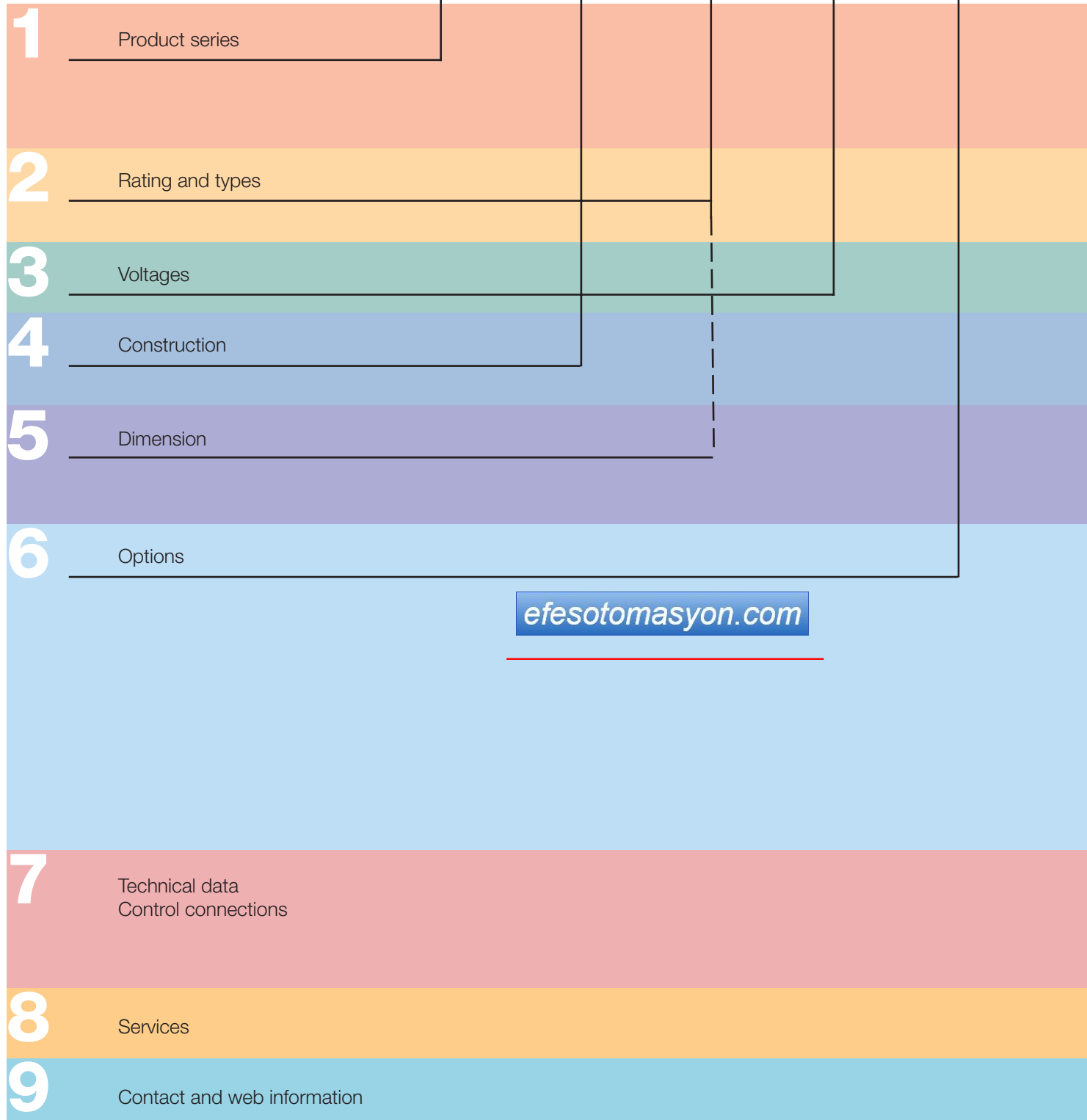

# Contents



## ABB general machinery drives, ACS350

ABB general machinery drives .....	4	<b>1</b>
Features .....	4	
Technical specification .....	5	
High protection class drive (IP66 and IP67) .....	6	<b>2</b>
Ratings, types, voltages and construction .....	7	
Type code .....	7	
Voltages .....	7	<b>3</b>
Construction .....	7	<b>4</b>
Dimensions .....	8	<b>5</b>
Cabinet-mounted drives .....	8	
Wall-mounted drives .....	8	
Options .....	9	<b>6</b>
How to select options .....	9	
User interfaces .....	10	
Machine interfaces .....	11	
Extension modules .....	11	
Protection and installation .....	11	
DriveWindow Light 2 .....	12	
FlashDrop tool .....	13	
Brake resistors .....	13	
Input and output chokes .....	14	
EMC filters .....	15	
Low leakage current filters .....	15	
Technical data .....	16	<b>7</b>
Cooling and fuses .....	16	
Control connections .....	17	
Connection examples .....	17	
Services .....	18	<b>8</b>
www.abb.com/drives .....	19	<b>9</b>

[efesotomasyon.com](http://efesotomasyon.com)

# ABB general machinery drives



ACS350 - 01E - 02A4 - 2 + A123

## ABB general machinery drives

ABB general machinery drives are designed for machine building. In serial type manufacturing the consumed time per unit is critical. The drives are designed to be the fastest drives in terms of installation, setting parameters and commissioning. The basic products have been made as user-friendly as possible, yet providing high intelligence. The drives offer diverse functionality to cater for the most demanding needs.

## Applications

ABB general machinery drives are designed to meet the requirements of an extensive range of machinery applications. The drives are ideal for food and beverage, material handling, textile, printing, rubber and plastics, and woodworking applications.

## Highlights

- Unified height and depth
- Convenient installation
- Optimized interfaces for users and machines
- Impressive software and compact hardware
- Sequence programming
- High ingress protection (IP66/IP67/UL Type 4X) variant as an option
- FlashDrop tool for fast parameter setting

Feature	Advantage	Benefit
FlashDrop tool	Faster and easier drive set up and commissioning for volume manufacturing and maintenance. The FlashDrop tool enables both downloading and uploading drive parameters.	Fast, safe and trouble-free parameter setting without the need to power-up the drive. Patented.
Sequence programming	Application specific 8-state programming with comprehensive transition and triggering conditions.	Logic programming included as standard. Reduces the need for external PLC.
Software	Excellent performance with exceptional flexibility. Software features include application macros, timed functions and fault history.	Quick and intuitive commissioning.
User interfaces	Panel cover for protection as standard. Assistant control panel with clear alphanumerical dynamic menus, real time clock and 14 languages. Basic panel with numerical display.	Cost efficient approach without control panels. Different control panels available according to functionality need.
Fieldbuses	Enclosed plug-in fieldbus adapters. The most common fieldbuses are available.	High speed communication with compact and robust fieldbus design.
Cabinet compatibility	Screw, DIN-rail, sideways and side-by-side mounting. Unified height and depth.	Optimum installation layout and efficient cabinet space usage.
Inbuilt EMC filter	EMC filter complying with IEC/EN 61800-3 as standard.	No extra space, parts, time or cost required.
Inbuilt brake chopper	100% braking capability.	Reduced cost, saved space and simple wiring.
Drive protection	Motor output and I/O protected against wiring faults. Protection against unstable supply networks. Coated boards included as standard.	Latest solutions to protect the drive and offer trouble free use and the highest quality.
High ingress protection as an option	No need to design special enclosure for applications that demand a high ingress protection. No need for external cooling fan. Wall mounted.	Time and cost savings. No maintenance of external moving parts. Can be located close to the process and operator.

[efesotomasyon.com](http://efesotomasyon.com)

# Technical specification



ACS350 - 01E - 02A4 - 2 + A123

## Mains connection

<b>Voltage and power range</b>	1-phase, 200 to 240 V $\pm$ 10% 0.37 to 2.2 kW (0.5 to 3 hp) 3-phase, 200 to 240 V $\pm$ 10% 0.37 to 11 kW (0.5 to 15 hp) 3-phase, 380 to 480 V $\pm$ 10% 0.37 to 22 kW (0.5 to 30 hp)
<b>Frequency</b>	48 to 63 Hz

## Motor connection

<b>Voltage</b>	3-phase, from 0 to $U_{SUPPLY}$
<b>Frequency</b>	0 to 500 Hz
<b>Continuous loading capability</b> <small>(constant torque at a max. ambient temperature of 40 °C)</small>	Rated output current $I_{2N}$
<b>Overload capacity</b> <small>(at a max. ambient temperature of 40 °C)</small>	1.5 x $I_{2N}$ for 1 minute every 10 minutes At start 1.8 x $I_{2N}$ for 2 s
<b>Switching frequency</b>	
Default	4 kHz
Selectable	4 to 16 kHz with 4 kHz steps
<b>Acceleration time</b>	0.1 to 1800 s
<b>Deceleration time</b>	0.1 to 1800 s
<b>Braking</b>	Inbuilt brake chopper as standard
<b>Speed control</b>	
Static accuracy	20% of motor nominal slip
Dynamic accuracy	< 1% s with 100% torque step
<b>Torque control</b>	
Torque step rise time	< 10ms with nominal torque
Non-linearity	$\pm$ 5% with nominal torque

## Environmental limits

<b>Ambient temperature</b>	-10 to 40 °C (14 to 104 °F), no frost allowed 50 °C (122 °F) with 10% derating
<b>Altitude</b>	Rated current available at 0 to 1000 m (0 to 3281 ft) reduced by 1% per 100 m (328 ft) over 1000 to 2000 m (3281 to 6562 ft)
<b>Relative humidity</b>	Lower than 95% (without condensation)
<b>Degree of protection</b>	IP20 / optional NEMA 1/ UL type 1 enclosure IP66/IP67/UL Type 4X as an option up to 7.5 kW, IP69K available for IP66/IP67 variant with compatible cable glands
<b>Enclosure colour</b>	NCS 1502-Y, RAL 9002, PMS 420 C
<b>Contamination levels</b>	IEC721-3-3 No conductive dust allowed
Transportation	Class 1C2 (chemical gases) Class 1S2 (solid particles)
Storage	Class 2C2 (chemical gases) Class 2S2 (solid particles)
Operation	Class 3C2 (chemical gases) Class 3S2 (solid particles)

## Product compliance

Low Voltage Directive 2006/95/EC  
Machinery Directive 2006/42/EC  
EMC Directive 2004/108/EC  
Quality assurance system ISO 9001  
Environmental system ISO 14001  
UL, cUL, CE, C-Tick and GOST R approvals  
RoHS compliant

## Programmable control connections

<b>Two analog inputs</b>	
Voltage signal	
Unipolar	0 (2) to 10 V, $R_{in} > 312$ k $\Omega$
Bipolar	-10 to 10 V, $R_{in} > 312$ k $\Omega$
Current signal	
Unipolar	0 (4) to 20 mA, $R_{in} = 100$ $\Omega$
Bipolar	-20 to 20 mA, $R_{in} = 100$ $\Omega$
Potentiometer reference value	10 V $\pm$ 1% max. 10 mA, $R < 10$ k $\Omega$
Resolution	0.1%
Accuracy	$\pm$ 1%
<b>One analog output</b>	0 (4) to 20 mA, load < 500 $\Omega$
<b>Auxiliary voltage</b>	24 V DC $\pm$ 10%, max. 200 mA
<b>Five digital inputs</b>	12 to 24 V DC with internal or external supply, PNP and NPN, pulse train 0 to 16 kHz
Input impedance	2.4 k $\Omega$
<b>One relay output</b>	
Type	NO + NC
Maximum switching voltage	250 V AC/30 V DC
Maximum switching current	0.5 A/30 V DC; 5 A/230 V AC
Maximum continuous current	2 A rms
<b>One digital output</b>	
Type	Transistor output
Maximum switching voltage	30 V DC
Maximum switching current	100 mA/30 V DC, short circuit protected
Frequency	10 to 16 kHz
Resolution	1 Hz
Accuracy	0.2%

## Serial communication

<b>Fieldbuses</b>	Plug-in type
Refresh rate	< 10 ms (between drive and fieldbus module)
<b>PROFIBUS DP</b>	9-pin D-connector Baud rate up to 12 Mbit/s PROFIBUS DP and PROFIBUS DPV1 Network side based on "PROFIdrive" profile.
<b>DeviceNet</b>	5-pin screw type connector Baud rate up to 500 kbit/s Network side based on ODVA "AC/DC drive" profile.
<b>CANopen</b>	9-pin D-connector Baud rate up to 1 Mbit/s Network side based on CiA DS402 profile.
<b>Modbus</b>	4-pin screw type connector Baud rate up to 115 kbit/s
<b>Ethernet</b>	RJ-45 connector 10 Mbit/s or 100 Mbit/s Modbus/TCP and EtherNet/IP Network side based on ODVA "AC/DC drive" profile (EtherNet/IP)

## Chokes

<b>AC input chokes</b>	External option For reducing THD in partial loads and to comply with EN/IEC 61000-3-12.
<b>AC output chokes</b>	External option To achieve longer motor cables



# ABB general machinery drives

## ACS350, IP66 and IP66

ACS350 - 01E - 02A4 - 2 + A123

### High protection class drive

A range of ABB general machinery drives with IP66 and IP67 protection classes is designed to excel in the harshest and most demanding of conditions.

Designed for the food and beverage, textile, ceramics, pulp and paper and water and waste water industries, the drives are suitable for screws, mixers, pumps, fans and conveyers especially where the machine is exposed to dust, moisture and cleaning chemicals. The heat sink's cooling fins are completely open from top to bottom, which allows easy washing to ensure no dirt adheres to the surfaces. A user control panel housed within a plastic window is designed to resist moist and dusty atmospheres. Furthermore, the cooling fan is located inside the drive, thereby eliminating the need for an external cooling fan and the subsequent maintenance of external moving parts.

The drive's hygienic design and use of materials meeting current hygiene standards, means that the drive traps no bacteria and can withstand frequent washing. The drive is certified by NSF.

The drive is designed for fast installation, parameter setting and commissioning and is based on ABB general machinery drives, possessing the same software features and hardware connections. The drive features the assistant control panel as standard. The wall mounted drive can be located close to the process and the operator.

### Mains connection

<b>Voltage and power range</b>	3-phase, 200 to 240 V ± 10%
	0.37 to 4 kW (0.5 to 5 hp)
	3-phase, 380 to 480 V ± 10%
	0.37 to 7.5 kW (0.5 to 10 hp)

### Environmental limits

<b>Ambient temperature</b>	-10 to 40 °C (14 to 104 °F), no frost allowed
<b>Degree of protection</b>	IP66/IP67/UL Type 4X, indoor use only IP69K with compatible cable glands

### Product compliance

Low Voltage Directive 73/23/EEC with supplements  
Machinery Directive 98/37/EC  
EMC Directive 89/336/EEC with supplements  
Quality assurance system ISO 9001  
Environmental system ISO 14001  
CE and C-Tick approvals  
UL and cUL pending  
GOST R approval  
RoHS compliant  
NSF Certified  
DIN40050-9 (IP69K)

[efesotomasyon.com](http://efesotomasyon.com)



# Ratings, types, voltages and construction



ACS350 - 01E - 02A4 - 2 + A123

## Type code

This is the unique reference number (shown above and in column 4, right) that clearly identifies your drive by power rating and frame size. Once you have selected the type code, the frame size (column 5) can be used to determine the drive dimensions, shown on the next page.

## Voltages

ACS350 is available in two voltage ranges:

2 = 200 - 240 V

4 = 380 - 480 V

Insert either "2" or "4", depending on your chosen voltage, into the type code shown above.

Ratings IP20 / UL Open Type / NEMA 1 option			Type code	Frame size
$P_N$ [kW]	$P_N$ [hp]	$I_{2N}$ [A]		
<b>1-phase supply voltage 200 - 240 V units</b>				
0.37	0.5	2.4	ACS350-01X-02A4-2	R0
0.75	1.0	4.7	ACS350-01X-04A7-2	R1
1.1	1.5	6.7	ACS350-01X-06A7-2	R1
1.5	2.0	7.5	ACS350-01X-07A5-2	R2
2.2	3.0	9.8	ACS350-01X-09A8-2	R2
<b>3-phase supply voltage 200 - 240 V units</b>				
0.37	0.5	2.4	ACS350-03X-02A4-2	R0
0.55	0.75	3.5	ACS350-03X-03A5-2	R0
0.75	1.0	4.7	ACS350-03X-04A7-2	R1
1.1	1.5	6.7	ACS350-03X-06A7-2	R1
1.5	2.0	7.5	ACS350-03X-07A5-2	R1
2.2	3.0	9.8	ACS350-03X-09A8-2	R2
3.0	4.0	13.3	ACS350-03X-13A3-2	R2
4.0	5.0	17.6	ACS350-03X-17A6-2	R2
5.5	7.5	24.4	ACS350-03X-24A4-2	R3
7.5	10.0	31.0	ACS350-03X-31A0-2	R4
11.0	15.0	46.2	ACS350-03X-46A2-2	R4
<b>3-phase supply voltage 380 - 480 V units</b>				
0.37	0.5	1.2	ACS350-03X-01A2-4	R0
0.55	0.75	1.9	ACS350-03X-01A9-4	R0
0.75	1.0	2.4	ACS350-03X-02A4-4	R1
1.1	1.5	3.3	ACS350-03X-03A3-4	R1
1.5	2.0	4.1	ACS350-03X-04A1-4	R1
2.2	3.0	5.6	ACS350-03X-05A6-4	R1
3.0	4.0	7.3	ACS350-03X-07A3-4	R1
4.0	5.0	8.8	ACS350-03X-08A8-4	R1
5.5	7.5	12.5	ACS350-03X-12A5-4	R3
7.5	10.0	15.6	ACS350-03X-15A6-4	R3
11.0	15.0	23.1	ACS350-03X-23A1-4	R3
15.0	20.0	31.0	ACS350-03X-31A0-4	R4
18.5	25.0	38.0	ACS350-03X-38A0-4	R4
22.0	30.0	44.0	ACS350-03X-44A0-4	R4

## Construction

"01E" within the type code (shown above) varies depending on the drive phase and EMC filtering. Choose below the one you need.

01 = 1-phase

03 = 3-phase

E = EMC filter connected, 50 Hz frequency

U = EMC filter disconnected, 60 Hz frequency

(In case the filter is required it can easily be connected.)

B063 = IP66/IP67/UL Type 4X enclosure

Ratings IP66/IP67/UL Type 4X			Type code	Frame size
$P_N$ [kW]	$P_N$ [hp]	$I_{2N}$ [A]		
<b>3-phase supply voltage 200 - 240 V units</b>				
0.37	0.5	2.4	ACS350-03X-02A4-2 + B063	R1
0.55	0.75	3.5	ACS350-03X-03A5-2 + B063	R1
0.75	1.0	4.7	ACS350-03X-04A7-2 + B063	R1
1.1	1.5	6.7	ACS350-03X-06A7-2 + B063	R1
1.5	2.0	7.5	ACS350-03X-07A5-2 + B063	R1
2.2	3.0	9.8	ACS350-03X-09A8-2 + B063	R3
3.0	4.0	13.3	ACS350-03X-13A3-2 + B063	R3
4.0	5.0	17.6	ACS350-03X-17A6-2 + B063	R3
<b>3-phase supply voltage 380 - 480 V units</b>				
0.37	0.5	1.2	ACS350-03X-01A2-4 + B063	R1
0.55	0.75	1.9	ACS350-03X-01A9-4 + B063	R1
0.75	1.0	2.4	ACS350-03X-02A4-4 + B063	R1
1.1	1.5	3.3	ACS350-03X-03A3-4 + B063	R1
1.5	2.0	4.1	ACS350-03X-04A1-4 + B063	R1
2.2	3.0	5.6	ACS350-03X-05A6-4 + B063	R1
3.0	4.0	7.3	ACS350-03X-07A3-4 + B063	R1
4.0	5.0	8.8	ACS350-03X-08A8-4 + B063	R1
5.5	7.5	12.5	ACS350-03X-12A5-4 + B063	R3
7.5	10.0	15.6	ACS350-03X-15A6-4 + B063	R3

X within the type code stands for E or U.

# Dimensions



ACS350 - 01E - 02A4 - 2 + A123

## Cabinet-mounted drives (IP20 UL Open)

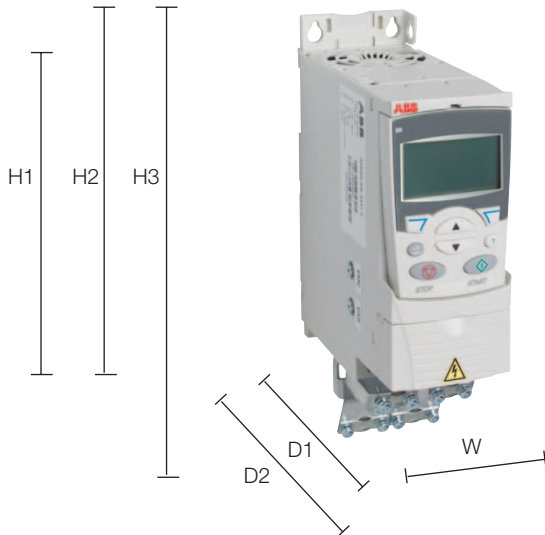

## Wall-mounted drives (NEMA 1/UL Type 1)

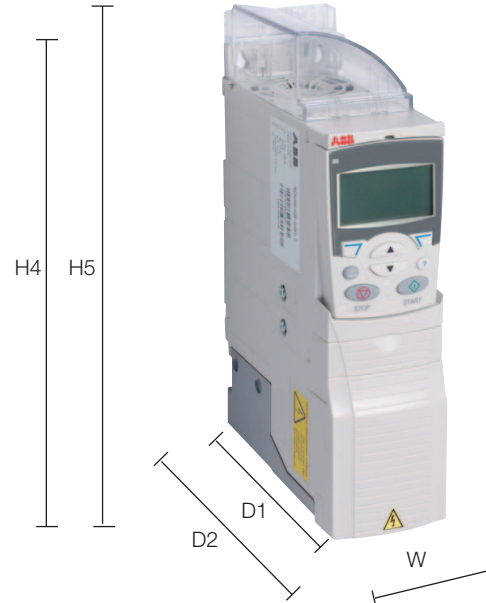

## Wall-mounted drives (IP66/IP67/UL Type 4X)



Frame size	IP20 UL Open							IP66/IP67/UL Type 4X				NEMA 1/UL Type 1					
	H1 mm	H2 mm	H3 mm	W mm	D1 mm	D2 mm	Weight kg	H mm	W mm	D1 mm	Weight kg	H4 mm	H5 mm	W mm	D1 mm	D2 mm	Weight kg
R0	169	202	239	70	161	187	1.2	-	-	-	-	257	280	70	169	187	1.6
R1	169	202	239	70	161	187	1.2	305	195	281	7.7	257	280	70	169	187	1.6
R2	169	202	239	105	165	191	1.5	-	-	-	-	257	282	105	169	191	1.9
R3	169	202	236	169	169	195	2.5	436	246	277	13	260	299	169	177	195	3.1
R4	181	202	244	260	169	195	4.4	-	-	-	-	270	320	260	177	195	5.0

H = Height

H1 = Height without fastenings and clamping plate

H2 = Height with fastenings but without clamping plate

H3 = Height with fastenings and clamping plate

H4 = Height with fastenings and NEMA 1 connection box

H5 = Height with fastenings, NEMA 1 connection box and hood

W = Width

D1 = Standard depth

D2 = Depth with MREL or MTAC option

# Options



ACS350 - 01E - 02A4 - 2 + A123

## How to select options

The options shown in the table are available within the ACS350 range. The ordering code, which is shown in the second column, replaces the A123 in the type code above. You can order as many options as required, simply by extending the code as necessary.

Options	Ordering code	Description	Model	Availability	
				IP20 drive	IP66/67 drive
Protection class	*)	NEMA 1/UL type 1 (R0, R1, R2)	MUL1-R1	■	-
	*)	NEMA 1/UL type 1 (R3)	MUL1-R3	■	-
	*)	NEMA 1/UL type 1 (R4)	MUL1-R4	■	-
	B063	IP66/IP67/UL type 4X enclosure		-	■
Control panel (choose one option only)	J400	Assistant control panel	ACS-CP-A	□	●
	J404	Basic control panel	ACS-CP-C	□	-
Panel mounting kit	*)	Panel mounting kit	ACS/H-CP-EXT	□	-
	*)	Panel holder mounting kit	OPMP-01	□	-
Potentiometer	J402	Potentiometer	MPOT-01	□	-
Fieldbus (choose one option only)	K451	DeviceNet	FDNA-01	□	□
	K454	PROFIBUS DP	FPBA-01	□	□
	K457	CANopen	FCAN-01	□	□
	K458	ModBus RTU	FMBA-01	□	□
	K466	Ethernet	FENA-01	□	□
	*)	RS-485/Modbus	FRSA-00	□	□
Fieldbus power module	*)	Auxiliary power module for fieldbus	FEPA-01	□ <sup>1)</sup>	□
Extension modules (choose one option only)	*)	Speed encoder module	MTAC-01	□	-
	*)	Relay output module	MREL-01	□	-
Remote monitoring	*)	Ethernet adapter	SREA-01	□	□
Connection options	H376	Cable gland kit		-	□
	F278	Input switch kit		-	□
Pressure compensation	C169	Pressure compensation valve		-	□
Tools	*)	FlashDrop tool	MFDT-01	□	□
	*)	DriveWindow Light 2	DriveWindow Light 2	□	□
External options	*)	Input chokes		□	□ <sup>2)</sup>
	*)	EMC filters		□	□ <sup>2)</sup>
	*)	Braking resistors		□	□ <sup>2)</sup>
	*)	Output chokes		□	□ <sup>2)</sup>

● = standard

■ = product variant

□ = option, external

- = not available

\*) = Ordering with a separate MRP code number.

<sup>1)</sup> Option not available with NEMA 1/UL Type 1

<sup>2)</sup> Options only with IP2x



# Options Interfaces

ACS350 - 01E - 02A4 - 2 + A123

## User interfaces

### Panel cover

The purpose of the panel cover is to protect the drive's connection surfaces. The ACS350 drive is delivered with a panel cover as standard. In addition there are two alternative control panels available as options.

### Basic control panel

The basic control panel features a single line numeric display. The panel can be used to control the drive, set the parameter values or copy them from one drive to another.

### Assistant control panel

The assistant control panel features a multilingual alphanumeric display for easy drive programming. The control panel has various assistants and an inbuilt help function to guide the user. It includes a real time clock, which can be used during fault logging and in controlling the drive, such as start/stop. The control panel can be used for copying parameters for back up or for downloading to another drive. A large graphical display and soft keys make it extremely easy to navigate. The drive with IP66/IP67 enclosure has the assistant control panel as standard.

### Potentiometer

Potentiometer MPOT-01 with two switches: start/stop and forward/reverse. Polarity is selected with DIP switches. No external power source is needed for the potentiometer.

### Panel mounting kits

To attach the control panel to the outside of a larger enclosure, two panel mounting kits are available. A simple and cost-efficient installation is possible with the ACS/H-CP-EXT kit, while the OPMP-01 kit provides a more user-friendly solution, including a panel platform that enables the panel to be removed in the same way as a drive-mounted panel. The panel mounting kits include all hardware required, including 3 m extension cables and installation instructions.



Panel cover (included as standard)



Basic control panel



Assistant control panel



Potentiometer



Panel holder mounting kit OPMP-01



MTAC-01 module

# Options Interfaces



ACS350 - 01E - 02A4 - 2 + A123



Fieldbus module

NEMA 1/UL type 1 kit

## Machine interfaces

The plug-in fieldbus modules bring connectivity to major automation systems. A single twisted pair cable avoids large amounts of conventional cabling, thereby reducing costs and increasing system reliability.

ACS350 supports the following fieldbus options:

- PROFIBUS DP
- CANopen
- DeviceNet
- Modbus RTU
- Ethernet

The optional FEPA-01 module provides auxiliary power for the fieldbus module in case of a mains power interruption. This module is compatible with all fieldbus modules for ACS350.

## Extension modules

### MREL-01

ACS350 has one relay output as standard. The optional MREL-01 module offers three additional relay outputs, which can be configured for different functions with parameters.

### MTAC-01

The optional MTAC-01 module offers pulse encoder interface for speed measurement.

## Protection and installation

### NEMA 1/UL Type 1 kit

The NEMA 1/UL Type 1 kit includes a connection box for finger protection, conduit tube installation, and a hood for protection against dirt and dust.

### Terminal cover

The terminal cover is for protection of the I/O connections.

### Clamping plates

The clamping plates are used for protection against electrical disturbances. The clamping plates with clamps are included in the drive package as standard.

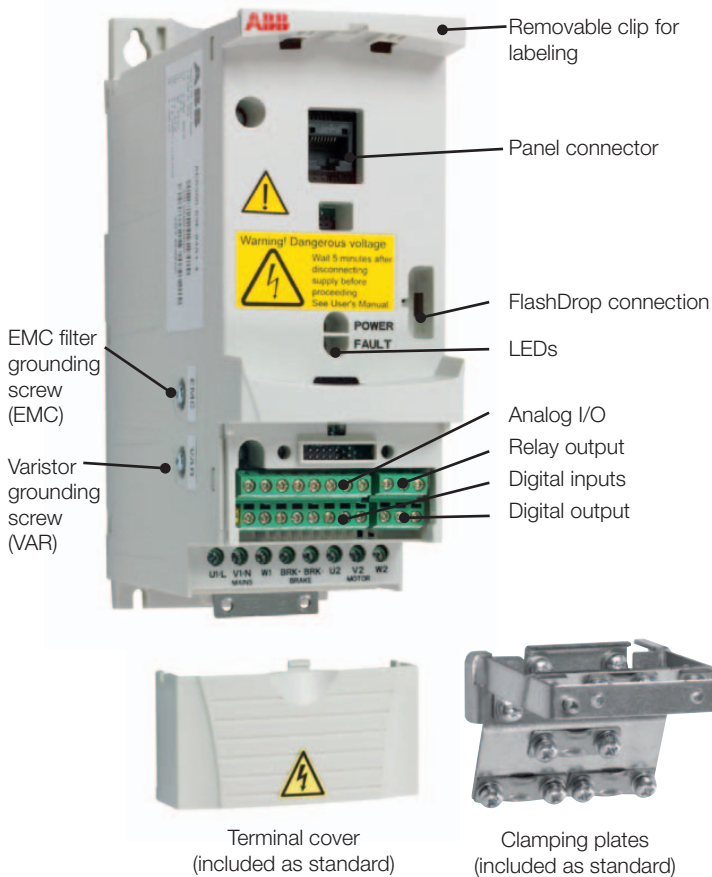



# Options

## Software tools

A separate order line and type code is required for any of these software tool options.

### DriveWindow Light 2

DriveWindow Light 2 is an easy-to-use start-up and maintenance tool for ACS350 drives. It can be used in an offline mode, which enables parameter setting at the office even before going to the actual site. The parameter browser enables viewing, editing and saving of parameters. The parameter comparison feature makes it possible to compare parameter values between the drive and saved parameter files. With the parameter subset you can create your own parameter sets. Controlling of the drive is naturally one of the features in DriveWindow Light. With this software tool, you can monitor up to four signals simultaneously. This can be done in both graphical and numerical format. Any signal can be set to stop the monitoring from a predefined level.

### Sequence programming tool

DriveWindow Light 2 allows the user to visually build and manipulate sequence programming parameters that are loaded into the ACS350. The programming is done in a graphical editor which displays each sequence step as an individual block.

Sequence programming enables application specific programming. This new and easy way to preset sequences reduces the need for an external programmable logic control (PLC). In simple applications an external PLC can be left out.

### Start-up wizards

Start-up wizards make the setting of parameters easy. Simply launch the wizard, select an appropriate assistant e.g. for setting analog outputs, and all parameters related to this function are shown together with help pictures.

### Highlights

- Graphical sequence programming tool for ACS350
- Editing, saving and downloading parameters
- Graphical and numerical signal monitoring
- Drive control
- Start-up wizards

### DriveWindow Light requirements

- Windows NT/2000/XP/Vista
- Free serial port from a PC
- Free control panel connector

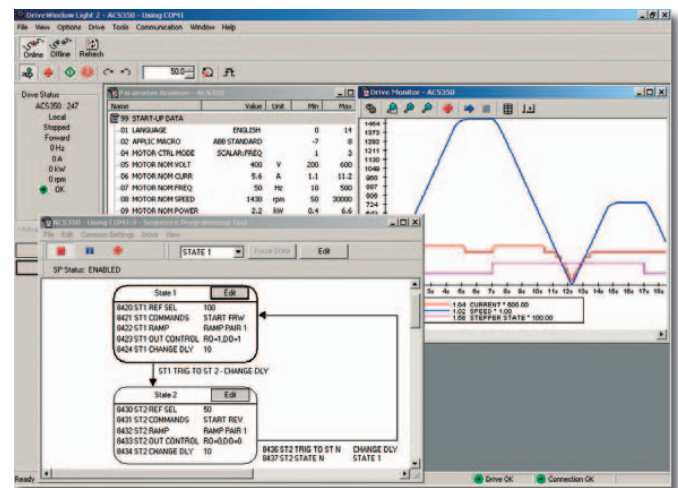



# Options

## External

A separate order line and type code is required for any of these external options.

### FlashDrop tool

FlashDrop is a powerful palm sized tool for fast and easy parameter selecting and setting. It gives the possibility to hide selected parameters to protect the machine. Only the parameters needed in the application are shown. The tool can copy parameters between two drives or between a PC and a drive. All the above can be done without a power connection to the drive – in fact, it is not even necessary to unpack the drive.

### DrivePM

DrivePM (Drive parameter manager) is a tool to create, edit and copy parameter sets for FlashDrop. For each parameter/group the user has a possibility to hide it, which means that the drive user does not see the parameter/group at all.

### DrivePM requirements

- Windows 2000/XP/Vista
- Free serial port from a PC

### FlashDrop package includes

- FlashDrop tool
- DrivePM software on a CD-rom
- User's manual in English and in pdf-format on the CD-rom
- Cable OPCA-02 for connection between the PC and FlashDrop tool
- Battery charger



### Brake resistors

ACS350 is delivered with an integrated brake chopper as standard. Therefore no additional space or installation time is needed. The brake resistor is selected using the table below. For more information about the selection of brake resistors, see the ACS350 User's Manual.

### Brake chopper limits and resistor selection table

Type code ACS350-	$R_{min}$ [ohm]	$P_{BRmax}$ [kW] [hp]		Selection table by resistor type						
				CBR-V / CBT-V						Braking time <sup>1)</sup> [s]
				160	210	260	460	660	560	
<b>1-phase supply voltage 200 - 240 V units</b>										
01X-02A4-2	70	0.37	0.5	●						90
01X-04A7-2	40	0.75	1	●						45
01X-06A7-2	40	1.1	1.5	●						28
01X-07A5-2	30	1.5	2	●						19
01X-09A8-2	30	2.2	3	●						14
<b>3-phase supply voltage 200 - 240 V units</b>										
03X-02A4-2	70	0.37	0.5	●						90
03X-03A5-2	70	0.55	0.75	●						60
03X-04A7-2	40	0.75	1	●						42
03X-06A7-2	40	1.1	1.5	●						29
03X-07A5-2	30	1.5	2	●						19
03X-09A8-2	30	2.2	3	●						14
03X-13A3-2	30	3	4			●				16
03X-17A6-2	30	4	5			●				12
03X-24A4-2	18	5.5	7.5						●	45
03X-31A0-2	7	7.5	10						●	35
03X-46A2-2	7	11	15						●	23
<b>3-phase supply voltage 380 - 480 V units</b>										
03X-01A2-4	200	0.37	0.5		●					90
03X-01A9-4	175	0.55	0.75		●					90
03X-02A4-4	165	0.75	1		●					60
03X-03A3-4	150	1.1	1.5		●					37
03X-04A1-4	130	1.5	2		●					27
03X-05A6-4	100	2.2	3		●					17
03X-07A3-4	70	3	4				●			29
03X-08A8-4	70	4	5				●			20
03X-12A5-4	40	5.5	7.5				●			15
03X-15A6-4	40	7.5	10				●			10
03X-23A1-4	30	11	15					●		10
03X-31A0-4	16	15	20						●	16
03X-38A0-4	13	18.5	25						●	13
03X-44A0-4	13	22	30						●	10

X within the type code stands for E or U.

<sup>1)</sup> Braking time = Maximum allowed braking time in seconds at  $P_{BRmax}$  every 120 seconds, at 40 °C ambient temperature

Ratings by resistor type	CBR-V 160	CBR-V 210	CBR-V 260	CBR-V 460	CBR-V 660	CBT-V 560
Nominal power [W]	280	360	450	790	1130	2200
Resistance [ohm]	70	200	40	80	33	18

# Options

## External



A separate order line and type code is required for any of these external options.

### Input chokes

Input choke smooths the wave shape of mains current and reduces total harmonic distortion (THD). Together with the input choke, the ACS350 is designed to fulfill the requirements of the harmonics standard EN/IEC 61000-3-12. In addition, the input choke provides improved protection against mains voltage transients.

Type code ACS350-	Frame size	Input choke	$I_{IN}$ without choke [A]	$I_{IN}$ with choke [A]	$I_{TH}$ [A]	$L$ [mH]
<b>1-phase supply voltage 200 - 240 V units</b>						
01X-02A4-2	R0	CHK-A1	6.1	4.5	5	8.0
01X-04A7-2	R1	CHK-B1	11.4	8.1	10	2.8
01X-06A7-2	R1	CHK-C1	16.1	11	16	1.2
01X-07A5-2	R2	CHK-C1	16.8	12	16	1.2
01X-09A8-2	R2	CHK-D1	21	15	25	1.0
<b>3-phase supply voltage 200 - 240 V units</b>						
03X-02A4-2	R0	CHK-01	4.3	2.2	4.2	6.4
03X-03A5-2	R0	CHK-02	6.1	3.6	7.6	4.6
03X-04A7-2	R1	CHK-03	7.6	4.8	13	2.7
03X-06A7-2	R1	CHK-03	11.8	7.2	13	2.7
03X-07A5-2	R1	CHK-04	12	8.2	22	1.5
03X-09A8-2	R2	CHK-04	14.3	11	22	1.5
03X-13A3-2	R2	CHK-04	21.7	14	22	1.5
03X-17A6-2	R2	CHK-04	24.8	18	22	1.5
03X-24A4-2	R3	CHK-06	41	27	47	0.7
03X-31A0-2	R4	CHK-06	50	34	47	0.7
03X-46A2-2	R4	CHK-06	69	47	47	0.7
<b>3-phase supply voltage 380 - 480 V units</b>						
03X-01A2-4	R0	CHK-01	2.2	1.4	4.2	6.4
03X-01A9-4	R0	CHK-01	3.6	2.3	4.2	6.4
03X-02A4-4	R1	CHK-01	4.1	2.7	4.2	6.4
03X-03A3-4	R1	CHK-01	6	3.7	4.2	6.4
03X-04A1-4	R1	CHK-02	6.9	4.5	7.6	4.6
03X-05A6-4	R1	CHK-02	9.6	6	7.6	4.6
03X-07A3-4	R1	CHK-02	11.6	7.8	7.6	4.6
03X-08A8-4	R1	CHK-03	13.6	9.5	13	2.7
03X-12A5-4	R3	CHK-03	18.8	13	13	2.7
03X-15A6-4	R3	CHK-04	22.1	18	22	1.5
03X-23A1-4	R3	CHK-04	30.9	22	22	1.5
03X-31A0-4	R4	CHK-05	52	33	33	1.1
03X-38A0-4	R4	CHK-06	61	41	47	0.7
03X-44A0-4	R4	CHK-06	67	47	47	0.7

$I_{IN}$  = Nominal input current  
 $I_{TH}$  = Nominal choke thermal current  
 $L$  = Choke inductance

### Output chokes

Output choke decreases du/dt on the output and filters current spikes caused by voltage spikes. With an output choke it is possible to increase the motor cable length which could be otherwise limited due to a temperature increase resulting from current spikes and electromagnetic performance.

Type code ACS350-	Frame size	Output choke	Cable length [m]
<b>1-phase supply voltage 200 - 240 V units</b>			
01X-02A4-2	R0	ACS-CHK-B3	60
01X-04A7-2	R1	ACS-CHK-B3	100
01X-06A7-2	R1	ACS-CHK-C3	100
01X-07A5-2	R2	ACS-CHK-C3	100
01X-09A8-2	R2	ACS-CHK-C3	100
<b>3-phase supply voltage 200 - 240 V units</b>			
03X-02A4-2	R0	ACS-CHK-B3	60
03X-03A5-2	R0	ACS-CHK-B3	60
03X-04A7-2	R1	ACS-CHK-B3	100
03X-06A7-2	R1	ACS-CHK-C3	100
03X-07A5-2	R1	ACS-CHK-C3	100
03X-09A8-2	R2	ACS-CHK-C3	100
03X-13A3-2	R2	NOCH-0016-6x	100
03X-17A6-2	R2	NOCH-0016-6x	100
03X-24A4-2	R3	NOCH-0030-6x	100
03X-31A0-2	R4	NOCH-0030-6x	100
03X-46A2-2	R4	NOCH-0070-6x	100
<b>3-phase supply voltage 380 - 480 V units</b>			
03X-01A2-4	R0	ACS-CHK-B3	60
03X-01A9-4	R0	ACS-CHK-B3	60
03X-02A4-4	R1	ACS-CHK-B3	100
03X-03A3-4	R1	ACS-CHK-B3	100
03X-04A1-4	R1	ACS-CHK-C3	100
03X-05A6-4	R1	ACS-CHK-C3	100
03X-07A3-4	R1	NOCH-0016-6x	100
03X-08A8-4	R1	NOCH-0016-6x	100
03X-12A5-4	R3	NOCH-0016-6x	100
03X-15A6-4	R3	NOCH-0016-6x	100
03X-23A1-4	R3	NOCH-0030-6x	100
03X-31A0-4	R4	NOCH-0030-6x	100
03X-38A0-4	R4	NOCH-0030-6x	100
03X-44A0-4	R4	NOCH-0030-6x	100

# Options

## External



A separate order line and type code is required for any of these external options.

### EMC filters

The ACS350's internal EMC filter is designed to meet category C3 requirements of EN/IEC 61800-3 standard. External EMC filters are used to enhance the drives electromagnetic performance in conjunction with its internal filtering. Maximum motor cable length depends on required electromagnetic performance, according to the table below.

Type code ACS350-	Frame size	Filter type	Cable length <sup>1)</sup> with external EMC filter			Cable length <sup>1)</sup> without external EMC filter	
			C1 [m]	C2 [m]	C3 [m]	C3 [m]	C4 [m]
<b>1-phase supply voltage 200 - 240 V units</b>							
01X-02A4-2	R0	RFI-11	10	30	-	30	30
01X-04A7-2	R1	RFI-12	10	30	50	30	50
01X-06A7-2	R1	RFI-12	10	30	50	30	50
01X-07A5-2	R2	RFI-13	10	30	50	30	50
01X-09A8-2	R2	RFI-13	10	30	50	30	50
<b>3-phase supply voltage 200 - 240 V units</b>							
03X-02A4-2	R0	RFI-32	10	30	-	30	30
03X-03A5-2	R0	RFI-32	10	30	-	30	30
03X-04A7-2	R1	RFI-32	10	30	50	30	50
03X-06A7-2	R1	RFI-32	10	30	50	30	50
03X-07A5-2	R1	RFI-32	10	30	50	30	50
03X-09A8-2	R2	RFI-32	10	30	50	30	50
03X-13A3-2	R2	RFI-33	10	30	50	30	50
03X-17A6-2	R2	RFI-33	10	30	50	30	50
03X-24A4-2	R3	RFI-34	10	30	50	30	50
03X-31A0-2	R4	RFI-34	10	30	50	30	50
03X-46A2-2	R4	RFI-34	10	30	50	30	50
<b>3-phase supply voltage 380 - 480 V units</b>							
03X-01A2-4	R0	RFI-32	30	30	-	30	30
03X-01A9-4	R0	RFI-32	30	30	-	30	30
03X-02A4-4	R1	RFI-32	50	50	50	30	50
03X-03A3-4	R1	RFI-32	50	50	50	30	50
03X-04A1-4	R1	RFI-32	50	50	50	30	50
03X-05A6-4	R1	RFI-32	50	50	50	30	50
03X-07A3-4	R1	RFI-32	50	50	50	30	50
03X-08A8-4	R1	RFI-32	50	50	50	30	50
03X-12A5-4	R3	RFI-33	40	40	40	30	50
03X-15A6-4	R3	RFI-33	40	40	40	30	50
03X-23A1-4	R3	RFI-33	40	40	40	30	50
03X-31A0-4	R4	RFI-34	-	30	-	30	50
03X-38A0-4	R4	RFI-34	-	30	-	30	50
03X-44A0-4	R4	RFI-34	-	30	-	30	50

<sup>1)</sup> Internal EMC filter must be connected with the EMC screw in the drive. When the filter is not connected the C4 maximum cable lengths are allowed to be used.

### Low leakage current filters

Low leakage current filters are ideal for installations where residual current devices (RCD) are required and leakage current needs to be below 30 mA.

Type code ACS350-	Frame size	Filter type	Cable length <sup>1)</sup> with LRFI filter
			C2 [m]
<b>Low leakage current filters, 3-phase supply voltage 400 V units</b>			
03X-01A2-4	R0	LRFI-31	10
03X-01A9-4	R0	LRFI-31	10
03X-02A4-4	R1	LRFI-31	10
03X-03A3-4	R1	LRFI-31	10
03X-04A1-4	R1	LRFI-31	10
03X-05A6-4	R1	LRFI-31	10
03X-07A3-4	R1	LRFI-32	10
03X-08A8-4	R1	LRFI-32	10

<sup>1)</sup> Internal EMC filter must be disconnected by removing the EMC screw from the drive.

### EMC standards in general

EN 61800-3 (2004), product standard	EN 55011, product family standard for industrial, scientific and medical (ISM) equipment	EN 61800-3/A11 (2000), product standard
Category C1	Group 1 Class B	1 <sup>st</sup> environment, unrestricted distribution
Category C2	Group 1 Class A	1 <sup>st</sup> environment, restricted distribution
Category C3	Group 2 Class A	2 <sup>nd</sup> environment, unrestricted distribution
Category C4	Not applicable	2 <sup>nd</sup> environment, restricted distribution



## Cooling

ACS350 is fitted with cooling fans as standard. The cooling air must be free from corrosive substances and must not be above the maximum ambient temperature of 40 °C (50 °C with derating). Heat dissipation from IP66/IP67 drive equals to the IP20 values. For more specific limits see the Technical specification - Environmental limits in this catalogue.

### Cooling air flow

Type code	Frame size	Heat dissipation		Air flow	
		w	BTU/Hr	m <sup>3</sup> /h	ft <sup>3</sup> /min
<b>1-phase supply voltage 200 - 240 V units</b>					
ACS350-01X-02A4-2	R0	48	163	-*)	-*)
ACS350-01X-04A7-2	R1	72	247	24	14
ACS350-01X-06A7-2	R1	97	333	24	14
ACS350-01X-07A5-2	R2	101	343	21	12
ACS350-01X-09A8-2	R2	124	422	21	12
<b>3-phase supply voltage 200 - 240 V units</b>					
ACS350-03X-02A4-2	R0	42	142	-*)	-*)
ACS350-03X-03A5-2	R0	54	183	-*)	-*)
ACS350-03X-04A7-2	R1	64	220	24	14
ACS350-03X-06A7-2	R1	86	295	24	14
ACS350-03X-07A5-2	R1	88	302	21	12
ACS350-03X-09A8-2	R2	111	377	21	12
ACS350-03X-13A3-2	R2	140	476	52	31
ACS350-03X-17A6-2	R2	180	613	52	31
ACS350-03X-24A4-2	R3	285	975	71	42
ACS350-03X-31A0-2	R4	328	1119	96	57
ACS350-03X-46A2-2	R4	488	1666	96	57
<b>3-phase supply voltage 380 - 480 V units</b>					
ACS350-03X-01A2-4	R0	35	121	-*)	-*)
ACS350-03X-01A9-4	R0	40	138	-*)	-*)
ACS350-03X-02A4-4	R1	50	170	13	8
ACS350-03X-03A3-4	R1	60	204	13	8
ACS350-03X-04A1-4	R1	69	235	13	8
ACS350-03X-05A6-4	R1	90	306	19	11
ACS350-03X-07A3-4	R1	107	364	24	14
ACS350-03X-08A8-4	R1	127	433	24	14
ACS350-03X-12A5-4	R3	161	551	52	31
ACS350-03X-15A6-4	R3	204	697	52	31
ACS350-03X-23A1-4	R3	301	1029	71	42
ACS350-03X-31A0-4	R4	408	1393	96	57
ACS350-03X-38A0-4	R4	498	1700	96	57
ACS350-03X-44A0-4	R4	588	2007	96	57

X within the type code stands for E or U.

\*) Frame size R0 with free convection cooling.

### Free space requirements

Enclosure type	Space above mm	Space below mm	Space on left/right mm
All frame sizes	75	75	0
IP66/67 enclosure	75	75	20

## Fuses

Standard fuses can be used with ABB general machinery drives. For input fuse connections see table below.

### Selection table

Type code	Frame size	IEC Fuses		UL Fuses	
		[A]	Fuse type*)	[A]	Fuse type*)
<b>1-phase supply voltage 200 - 240 V units</b>					
ACS350-01X-02A4-2	R0	10	gG	10	UL class T
ACS350-01X-04A7-2	R1	16	gG	20	UL class T
ACS350-01X-06A7-2	R1	16/20 <sup>1)</sup>	gG	25	UL class T
ACS350-01X-07A5-2	R2	20/25 <sup>1)</sup>	gG	30	UL class T
ACS350-01X-09A8-2	R2	25/35 <sup>1)</sup>	gG	35	UL class T
<b>3-phase supply voltage 200 - 240 V units</b>					
ACS350-03X-02A4-2	R0	10	gG	10	UL class T
ACS350-03X-03A5-2	R0	10	gG	10	UL class T
ACS350-03X-04A7-2	R1	10	gG	15	UL class T
ACS350-03X-06A7-2	R1	16	gG	15	UL class T
ACS350-03X-07A5-2	R1	16	gG	15	UL class T
ACS350-03X-09A8-2	R2	16	gG	20	UL class T
ACS350-03X-13A3-2	R2	25	gG	30	UL class T
ACS350-03X-17A6-2	R2	25	gG	35	UL class T
ACS350-03X-24A4-2	R3	63	gG	60	UL class T
ACS350-03X-31A0-2	R4	80	gG	80	UL class T
ACS350-03X-46A2-2	R4	100	gG	100	UL class T
<b>3-phase supply voltage 380 - 480 V units</b>					
ACS350-03X-01A2-4	R0	10	gG	10	UL class T
ACS350-03X-01A9-4	R0	10	gG	10	UL class T
ACS350-03X-02A4-4	R1	10	gG	10	UL class T
ACS350-03X-03A3-4	R1	10	gG	10	UL class T
ACS350-03X-04A1-4	R1	16	gG	15	UL class T
ACS350-03X-05A6-4	R1	16	gG	15	UL class T
ACS350-03X-07A3-4	R1	16	gG	20	UL class T
ACS350-03X-08A8-4	R1	20	gG	25	UL class T
ACS350-03X-12A5-4	R3	25	gG	30	UL class T
ACS350-03X-15A6-4	R3	35	gG	35	UL class T
ACS350-03X-23A1-4	R3	50	gG	50	UL class T
ACS350-03X-31A0-4	R4	80	gG	80	UL class T
ACS350-03X-38A0-4	R4	100	gG	100	UL class T
ACS350-03X-44A0-4	R4	100	gG	100	UL class T

X within the type code stands for E or U.

\*) According to IEC-60269 standard.

<sup>1)</sup> If 50% overload capacity is needed, use the bigger fuse alternative.

# Control connections



The diagram below gives an overview of ACS350 control connections and shows the default I/O connections for the ABB standard macro. ACS350 has seven standard macros and three user macros. Please refer to the ACS350 User's Manual for more detailed description of each macro.

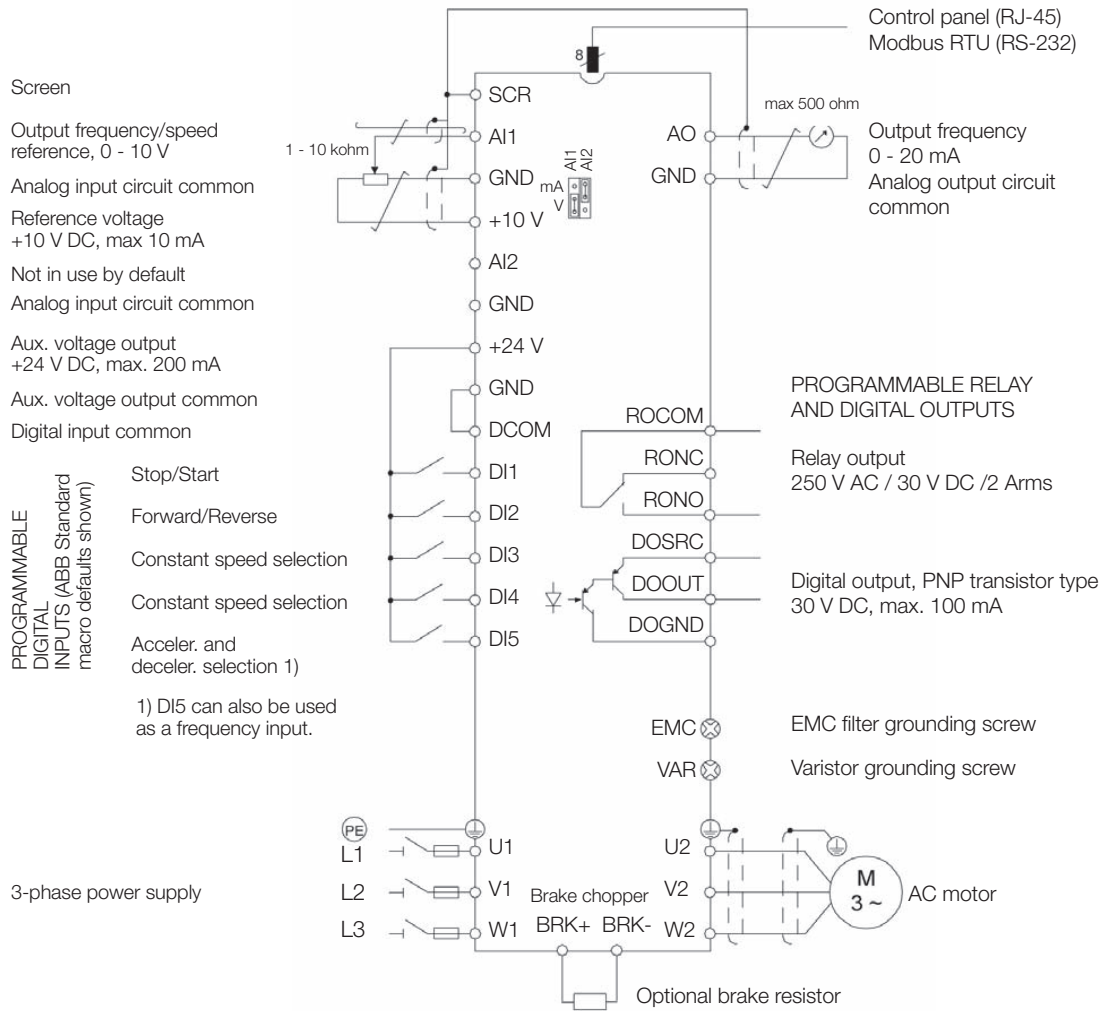

## Sinking DI configuration (NPN connected)

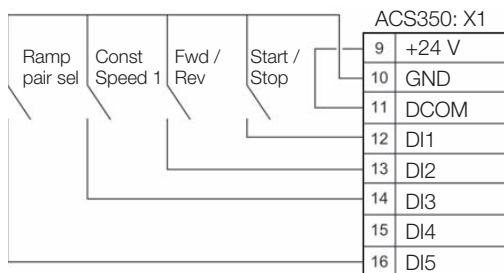

## Sourcing DI configuration (PNP connected) with external power supply

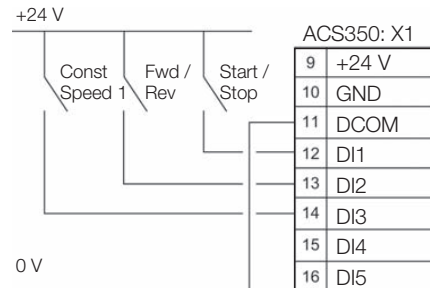

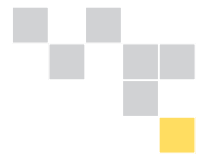

All industries face a common goal: to maximize their production output at the lowest possible cost, while maintaining the highest quality end products. One of ABB's key objectives is to maximize the uptime of its customers' processes by ensuring optimum lifetime of all ABB products in a predictable, safe and low cost manner.

The services offered for ABB low voltage drives span the entire value chain, from the moment a customer makes the first enquiry through to disposal and recycling of the drive. Throughout the value chain, ABB provides training and learning, technical support and contracts. All of this is supported by one of the most extensive global drive sales and service networks.

## Maximizing return on investment

At the heart of ABB's services is its drive lifecycle management model. All services available for ABB low voltage drives are planned according to this model. For customers it is easy to see which services are available at which phase.

precisely the timing of the part replacements plus all other maintenance related actions. The model also helps the customer when deciding about upgrades, retrofits and replacements.

Drive specific maintenance schedules are also based on this four-phase model. Thus, a customer knows

Professional management of the drive's lifecycle maximizes the return on any investment in ABB low voltage drives.

## ABB drive lifecycle management model



ABB follows a four-phase model for managing drive lifecycles, which brings enhanced customer support and improved efficiency.

Examples of lifecycle services are: selection and dimensioning, installation and commissioning, preventive and corrective maintenance, remote services, spare part services, training and learning, technical support, upgrade and retrofit, replacement and recycling.

# Contact and web information

[www.abb.com/drives](http://www.abb.com/drives)

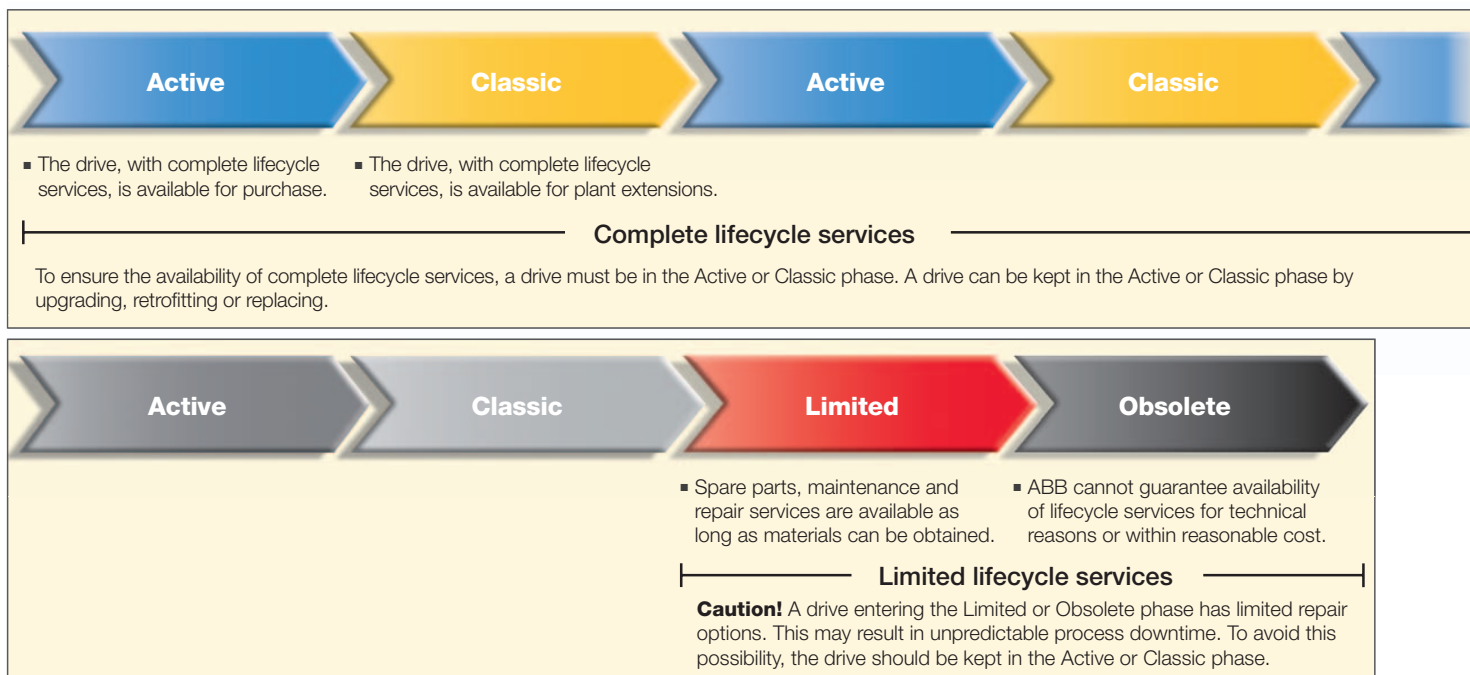

ABB's worldwide presence is built on strong local companies working together with the channel partner network. By combining the experience and know-how gained in local and global markets, we ensure that our customers in all industries can gain the full benefit from our products.

For further details about all our low voltage AC drives and services please contact your nearest ABB office or ABB drives channel partner or visit the websites [www.abb.com/drives](http://www.abb.com/drives) and [www.abb.com/drivespartners](http://www.abb.com/drivespartners).

## Albania (Tirana)

Tel: +355 42 241 492  
Fax: +355 42 234 368

## Algeria

Tel: +213 21 553 860  
Fax: +213 21 552 330

## Argentina (Valentin Alsina)

Tel: +54 11 4229 5500  
Fax: +54 11 4229 5784

## Australia (Victoria - Notting Hill)

Tel: +1800 222 435  
Tel: +61 3 8544 0000  
e-mail: [drives@au.abb.com](mailto:drives@au.abb.com)

## Austria (Vienna)

Tel: +43 1 60109 0  
Fax: +43 1 60109 8312

## Azerbaijan (Baku)

Tel: +994 12 404 5200  
Fax: +994 12 404 5022

## Bahrain (Manama)

Tel: +973 725 377  
Fax: +973 725 332

## Bangladesh (Dhaka)

Tel: +88 02 8856468  
Fax: +88 02 8850906

## Belarus (Minsk)

Tel: +375 228 12 40, 228 12 42  
Fax: +375 228 12 43

## Belgium (Zaventem)

Tel: +32 2 718 6320  
Fax: +32 2 718 6664

## Bolivia (La Paz)

Tel: +591 2 278 8181  
Fax: +591 2 278 8184

## Bosnia Herzegovina (Tuzla)

Tel: +387 35 246 020  
Fax: +387 35 255 098

## Brazil (Osasco)

Tel: 0800 014 9111  
Tel: +55 11 3688 9282  
Fax: +55 11 3688 9421

## Bulgaria (Sofia)

Tel: +359 2 807 5500  
Fax: +359 2 807 5599

## Canada (Montreal)

Tel: +1 514 420 3100  
Fax: +1 514 420 3138

## Chile (Santiago)

Tel: +56 2 471 4391  
Fax: +56 2 471 4399

## China (Beijing)

Tel: +86 10 5821 7788  
Fax: +86 10 5821 7618

## Colombia (Bogotá)

Tel: +57 1 417 8000  
Fax: +57 1 413 4086

## Costa Rica (San Jose)

Tel: +506 288 5484  
Fax: +506 288 5482

## Croatia (Zagreb)

Tel: +385 1 600 8550  
Fax: +385 1 619 5111

## Czech Republic (Prague)

Tel: +420 234 322 327  
e-mail: [motors&drives@cz.abb.com](mailto:motors&drives@cz.abb.com)

## Denmark (Skovlunde)

Tel: +45 44 504 345  
Fax: +45 44 504 365

## Dominican Republic (Santo Domingo)

Tel: +809 562 9010  
Fax: +809 562 9011

## Ecuador (Quito)

Tel: +593 2 2500 645  
Fax: +593 2 2500 650

## Egypt (Cairo)

Tel: +202 2 6251630  
e-mail: [drives@eg.abb.com](mailto:drives@eg.abb.com)

## El Salvador (San Salvador)

Tel: +503 2264 5471  
Fax: +503 2264 2497

## Estonia (Tallinn)

Tel: +372 6801 800  
e-mail: [info@ee.abb.com](mailto:info@ee.abb.com)

## Ethiopia (Addis Abeba)

Tel: +251 1 669506, 669507  
Fax: +251 1 669511

## Finland (Helsinki)

Tel: +358 10 22 11  
Tel: +358 10 222 1999  
Fax: +358 10 222 2913

## France (Montluel)

Tel: +33 (0)4 37 40 40 00  
Fax: +33 (0)4 37 40 40 72

## Germany (Ladenburg)

Tel: +01805 222 580 (Service)  
Tel: +49 (0)6203 717 717  
Fax: +49 (0)6203 717 600

## Greece (Athens)

Tel: +30 210 289 1 651  
Fax: +30 210 289 1 792

## Guatemala (Guatemala City)

Tel: +502 2 363 3814  
Fax: +502 2 363 3624

## Hungary (Budapest)

Tel: +36 1 443 2224  
Fax: +36 1 443 2144

## India (Bangalore)

Tel: +91 80 2294 9585  
Fax: +91 80 2294 9389

## Indonesia (Jakarta)

Tel: +62 21 2551 5555  
e-mail: [automation@id.abb.com](mailto:automation@id.abb.com)

## Iran (Tehran)

Tel: +98 21 2222 5120  
Fax: +98 21 2222 5157

## Ireland (Dublin)

Tel: +353 1 405 7300  
Fax: +353 1 405 7307

## Israel (Haifa)

Tel: +972 4 850 2111  
Fax: +972 4 850 2112

## Italy (Milan)

Tel: +39 02 2414 3085  
Fax: +39 02 2414 3979

## Ivory Coast (Abidjan)

Tel: +225 21 21 7575  
Fax: +225 21 35 0414

## Japan (Tokyo)

Tel: +81(0)3 5784 6010  
Fax: +81(0)3 5784 6275

## Jordan (Amman)

Tel: +962 6 562 0181  
Fax: +962 6 5621369

## Kazakhstan (Almaty)

Tel: +7 727 2583838  
Fax: +7 727 2583839

## Kenya (Nairobi)

Tel: +254 20 828811/13 to 20  
Fax: +254 20 828812/21

## Kuwait (Kuwait city)

Tel: +965 2428626 ext. 106  
Fax: +965 2403139

## Latvia (Riga)

Tel: +371 7 063 600  
Fax: +371 7 063 601

## Lithuania (Vilnius)

Tel: +370 5 273 8300  
Fax: +370 5 273 8333

## Luxembourg (Leudelange)

Tel: +352 493 116  
Fax: +352 492 859

## Macedonia (Skopje)

Tel: +389 23 118 010  
Fax: +389 23 118 774

## Malaysia (Kuala Lumpur)

Tel: +603 5628 4888  
Fax: +603 5635 8200

## Mauritius (Port-Louis)

Tel: +230 208 7644, 211 8624  
Fax: +230 211 4077

## Mexico (Mexico City)

Tel: +52 (55) 5328 1400 ext. 3008  
Fax: +52 (55) 5328 7467

## Morocco (Casablanca)

Tel: +212 52 234 5540  
Fax: +212 52 234 2099

## The Netherlands (Rotterdam)

Tel: +31 (0)10 407 8886  
e-mail: [freqconv@nl.abb.com](mailto:freqconv@nl.abb.com)

## New Zealand (Auckland)

Tel: +64 9 356 2160  
Fax: +64 9 357 0019

## Nigeria (Ikeja, Lagos)

Tel: +234 1 4937 347  
Fax: +234 1 4937 329

## Norway (Oslo)

Tel: +47 03500  
e-mail: [motor@no.abb.com](mailto:motor@no.abb.com)

## Oman (Muscat)

Tel: +968 2456 7410  
Fax: +968 2456 7406

## Pakistan (Lahore)

Tel: +92 42 6315 882-85  
Fax: +92 42 6368 565

## Panama (Panama City)

Tel: +507 209 5400, 2095408  
Fax: +507 209 5401

## Peru (Lima)

Tel: +51 1 415 5100  
Fax: +51 1 561 2902

## The Philippines (Metro Manila)

Tel: +63 2 821 7777  
Fax: +63 2 823 0309, 824 4637

## Poland (Lodz)

Tel: +48 42 299 3000  
Fax: +48 42 299 3340

## Portugal (Oeiras)

Tel: +351 21 425 6000  
Fax: +351 21 425 6390, 425 6354

## Qatar (Doha)

Tel: +974 4253888  
Fax: +974 4312630

## Romania (Bucharest)

Tel: +40 21 310 4377  
Fax: +40 21 310 4383

## Russia (Moscow)

Tel: +7 495 960 22 00  
Fax: +7 495 960 22 20

## Saudi-Arabia (Al Khobar)

Tel: +966 (0)3 882 9394, ext. 240, 254, 247  
Fax: +966 (0)3 882 4603

## Senegal (Dakar)

Tel: +221 832 1242, 832 3466  
Fax: +221 832 2057, 832 1239

## Serbia (Belgrade)

Tel: +381 11 3094 320, 3094 330  
Fax: +381 11 3094 343

## Singapore (Singapore)

Tel: +65 6776 5711  
Fax: +65 6778 0222

## Slovakia (Banska Bystrica)

Tel: +421 48 410 2324  
Fax: +421 48 410 2325

## Slovenia (Ljubljana)

Tel: +386 1 2445 440  
Fax: +386 1 2445 490

## South Africa (Johannesburg)

Tel: +27 11 617 2000  
Fax: +27 11 908 2061

## South Korea (Seoul)

Tel: +82 2 528 2794  
Fax: +82 2 528 2338

## Spain (Barcelona)

Tel: +34 (9)3 728 8500  
Fax: +34 (9)3 728 7659

## Sri Lanka (Colombo)

Tel: +94 11 2399304/6  
Fax: +94 11 2399303

## Sweden (Västerås)

Tel: +46 (0)21 32 5000  
Fax: +46 (0)21 14 8671

## Switzerland (Zürich)

Tel: +41 (0)58 586 0000  
Fax: +41 (0)58 586 0603

## Syrian Arab Republic

Tel: +963 11 212 7018 / 9551  
Fax: +963 11 212 8614

## Taiwan (Taipei)

Tel: +886 2 2577 6090  
Fax: +886 2 2577 9467, 2577 9434

## Tanzania (Dar es Salaam)

Tel: +255 51 2136750, 2136751, 2136752  
Fax: +255 51 2136749

## Thailand (Bangkok)

Tel: +66 (0)2665 1000  
Fax: +66 (0)2665 1042

## Tunisia (Tunis)

Tel: +216 71 860 366  
Fax: +216 71 860 255

## Turkey (Istanbul)

Tel: +90 216 528 2200  
Fax: +90 216 365 2944

## Uganda (Nakasero, Kampala)

Tel: +256 41 348 800  
Fax: +256 41 348 799

## Ukraine (Kiev)

Tel: +380 44 495 22 11  
Fax: +380 44 495 22 10

## The United Arab Emirates (Dubai)

Tel: +971 4 3147500, 3401777  
Fax: +971 4 3401771, 3401539

## United Kingdom (Daresbury, Warrington)

Tel: +44 1925 741 111  
Fax: +44 1925 741 693

## Uruguay (Montevideo)

Tel: +598 2 707 7300  
Tel: +598 2 707 7466

## USA (New Berlin)

Tel: +1 800 752 0696  
Tel: +1 262 785 3200  
Fax: +1 262 785 0397

## Venezuela (Caracas)

Tel: +58 212 2031949  
Fax: +58 212 237 6270

## Vietnam (Hochiminh)

Tel: +84 8 8237 972  
Fax: +84 8 8237 970

## Zimbabwe (Harare)

Tel: +263 4 369 070  
Fax: +263 4 369 084

# Contact us



411 024  
Printed matter  
ABB03\_00246/2009

[www.abb.com/drives](http://www.abb.com/drives)  
[www.abb.com/drivespartners](http://www.abb.com/drivespartners)

© Copyright 2009 ABB. All rights reserved.  
Specifications subject to change without notice.

3AFE68596106 REV G EN 25.8.2009. #14412